

# ***can-am***®



**Side-by-Side Product Spec Book**

**2024**

SSV Accessories and Parts & Maintenance



---

# TABLE OF CONTENTS

---

## CAN-AM TRAXTER

Accessories 5

## CAN-AM MAVERICK

Accessories 51

## CAN-AM MAVERICK R

Accessories 89

## CAN-AM COMMANDER, MAVERICK TRAIL & MAVERICK SPORT

Accessories 114

## PARTS AND MAINTENANCE

Keep an Eye on These Parts 162

Genuine Parts 166

Tires & Rims 170

Maintenance 177

### CANAMOFFROAD.COM

© 2023 Bombardier Recreational Products Inc. (BRP). All rights reserved. ®, TM and the BRP logo are trademarks of BRP or its affiliates. †All other trademarks are the property of their respective owners. BRP reserves the right to discontinue or change specifications, prices, designs, features, models or equipment without incurring obligation. Some models shown may include optional equipment. Products performance may vary depending on external factors. BRP recommends that all SSV drivers take a training course. See your dealer. SSV can be hazardous to operate. Never exceed the SSV's passenger capacity. All SSV models are meant to be used by drivers of aged 16 and older. Read the operator's guide. Follow all instructional and safety material and observe applicable laws and regulations. SSVs are primarily designed for use on unpaved surfaces (off-road); avoid paved surfaces. For your safety, the operator and passenger(s) must wear a helmet, eye protection and applicable protective clothing. Always remember that riding and alcohol/drugs don't mix. Never engage in stunt driving. Avoid excessive speed and be particularly careful on difficult terrain. Always ride responsibly and safely. See your authorised BRP dealer for details and visit <https://can-am.brp.com/>.





# IF WE SELL IT, WE STAND BY IT.

---

**BRP Limited Warranty\***  
for new Parts, Accessories  
and Riding Gear

---

**2-year limited warranty\*\***

- Genuine BRP Parts and Accessories installed by you or your authorised BRP dealer
- Aftermarket Products sold through BRP
- Riding Gear

**4-year limited warranty\*\***

- Helmets

GET ALL THE DETAILS FROM  
YOUR CAN-AM OFF-ROAD DEALER

\* Purchased at an authorised BRP dealership/distributor or on a BRP-authorised online store. Other exclusions may apply; see complete limited warranty or contact your Can-Am Off-Road authorised dealer. This limited warranty does not apply to factory-installed accessories and Evinrude parts and accessories.

\*\* Unless otherwise stipulated or required by law.





# CUSTOMISING MADE EASY

**1**

Select the model.

**2**

Select the package.

**3**

Customize color, engine, and accessories (or accessory bundles) for your vehicle.

**4**

Click “Save” or “Send to dealer.”



If you can dream it, you can build it. And ride it. Creating a Can-Am vehicle tailor-made for our riders' needs has never been easier. Scan the QR code and follow the step-by-step above.

**BUILD  
YOURS NOW**





---

# CAN-AM TRAXTER

---



# CAN-AM TRAXTER

## ACCESSORIES

Roofs	9
Cabs	10
Windshields & Mirrors	11
Rear Wind Protection	13
Doors	14
Seat Accessories	16
Aluminum Skid Plates	17
Bumpers & Guards	18
LinQ: Easy On, Easy Off Cargo	21
Cargo & Storage	26
Racks & Holders	29
Lights	32
Audio & Communication Systems	35
Electronic Accessories	36
Winches & Hitches	38
Performance	41
Apache Track Systems	43
ProMount Plows	46
Covers & Add-Ons	50







# TRAXTER ACCESSORIES



# BUNDLE UP TO GET IT ALL DONE. YOUR TRAXTER BUNDLES.

## STEP 1: CHOOSE YOUR ESSENTIAL BUNDLE

		Traxter	Traxter MAX	Traxter PRO and 6x6
<b>STARTER</b>	Sport Roof	715002430	715003038	715002430
	Flip Windshield - Hardcoated	715002442	715002442	715002442
	Rear Polycarbonate Window	715007081	715007081	715007081
	Side Mirror	715008101	715008101	715008100
	Dash Storage Compartment Nets	715003129	715003129	715003129
<b>ADVANCED</b>	LinQ Tailgate Extension/Divider	715002464	715002464	715005412
	LinQ Cargo Rack for Long Box	715006140	715006140	715006140
	Cargo Bed Protectors & Tie Rails	N/A	N/A	715005415
	LinQ 12 Gal (45 L) Cargo Box	715003879	715003879	715003879
	Rear Accessory Bar	715005450	715005450	715005450
	LinQ Adapter	715003058	715003058	715003058
<b>PEAK</b>	Rear View Mirror and Camera Monitor	715009410	715009410	715009410
	LinQ Tool Holder	715007358	715007358	715007358
	Fender Flares	715006821	715006821	715005409 6x6 715006001 Pro
	Center Underseat Storage Bin	715003446	715003446	715003446

## STEP 2: PICK YOUR ADD-ON BUNDLE

		Traxter	Traxter MAX	Traxter PRO and 6x6
<b>AUDIO</b>	Can-Am Audio Roof	715005206	N/A	715005206
	Can-Am Audio Roof MAX	N/A	715006879	N/A
	USB Power Outlet Kit	219400510	219400510	219400510
	Auxiliary Battery Installation Kit	715006035	715006035	715006035
<b>HUNT</b>	Dual Gun Holder	715005265	715005265	715005265
	Rock Sliders	715006671	715006721	715006721
	LinQ 8 Gal (30 L) Cooler Box	715004778	715004778	715004778
<b>WORK</b>	Deluxe Headache Rack	715002423	715002423	715002423
	LinQ Front Rack	715006064	715006064	715006064
	Front Bumper	715005754	715005754	715005754
	LinQ Tool & Gun Holder	715005466	715005466	715005466
<b>WINTER</b>	Front Soft Doors	715008059	715008059	715008059
	Rear Soft Doors	N/A	715006318	N/A
	Defrost, Heat & Ventilation System	715008093 715008095	715008093 715008095	715008093 715008095
	Tonneau Cover	715008306	715008306	N/A



# ROOFS

## Sport Roof

Traxter  
Traxter MAX

715002430  
715003038



- Robust injection-molded polypropylene construction.
- Provides added protection for rider and passenger from the elements.

## Deluxe Sport Roof

(Not illustrated)

Traxter  
Traxter MAX

715002511  
715003039

- Complete roof kit provides extra driver and passenger protection and also diminishes noise within the cab.
- Perfect fit and finish thanks to the seal kit and the liners included.
- Rear Roof Liner is not compatible with Soft Rear Panel.

Includes  
- Sport Roof  
- Sport Roof Seal Kit  
- Front Roof Liner  
- Rear Roof Liner

## Sport Roof Seal Kit

(Not illustrated)

Traxter  
Traxter MAX

715003126  
715003583

- Necessary when installing individual cab components with Sport Roof or when installing the Front and Rear Roof Liners.

## Bimini Roof with Sun Visor

Traxter (not compatible for use with soft and rigid full doors)  
Traxter MAX

■ 715003418 · Black  
■ 715003030 · Black



- Heavy-duty canvas made of UV-resistant polyester.
- Soft top comes with a hard visor that allows for storage of rolled-up soft top and mounting of Light Rack.
- Quick and easy installation.

## Front Roof Liner

Traxter, Traxter MAX

715008226



- Vehicle enhancement.
- Integrates seamlessly with roof-mounted light switch.
- Required for installation of roof-mounted lights and audio systems.
- Allows a better integration of Windshield Wiper and Washer Kit.
- Seal Kit necessary when installing with Sport Roof.

## Rear Roof Liner

Traxter<sup>†</sup>  
Traxter MAX<sup>‡</sup> (Not illustrated)

715006334  
715006391



- Quick and easy vehicle enhancement.
- Allows better integration of other accessories installed on the roof.
- Seal Kit necessary when installing with Sport Roof.
- Not compatible with: 715002920, 715006680, 715003249, 715002852.

<sup>†</sup>Needs to be installed with Sport Roof (715002430).

<sup>‡</sup>Needs to be installed with Sport Roof (715003038).



# CABS

## Hard Cabs

### Clear Rigid Cab



- Includes:
  - Front Clear Rigid Doors
  - Sport Roof
  - Flip Glass Windshield
  - Rear Polycarbonate Window
  - Sport Roof Seal Kit

Traxter (all model years) (except X mr models)  
Traxter MAX 2022 & up (except X mr models)

**715007269**  
**715007270**

*Installation of some accessories shown may impact vehicle compliance with some regulations. Consult your local dealer for information.*

### Deluxe Cab Enclosure



- Provides driver and passenger with the best protection from the elements and the cold, and features the most complete top-of-the-line accessories our product lineup has to offer.
- No locking system for the doors.

Traxter (all model years) (except X mr models)  
Traxter MAX 2022 & up (models produced after January 18, 2021) (except X mr models)

**715007417**  
**715007425**

- Includes:
  - Deluxe Sport Roof Kit
  - Flip Glass Windshield with Wiper and Washer Kit
  - Front Deluxe Full Doors and Color Panels required (sold separately)
  - Rear Glass Window with Sliding Panel
  - Wiper and Powered Windows Cable
  - Roof Power Cable

*Installation of some accessories shown may impact vehicle compliance with some regulations. Consult your local dealer for information.*

## Soft Cabs

### Soft Cab Enclosure

(Not illustrated)

Included:

- Sport Roof
- Full Windshield
- Hardcoated

Traxter (all model years)  
Traxter MAX 2018 & prior,  
Traxter MAX 2022 & up (models produced after January 18, 2021)

**715008063**  
**715008064**

- Soft Doors
- Rear Polycarbonate Window

*Installation of some accessories shown may impact vehicle compliance with some regulations. Consult your local dealer for information.*

## Cab Kits – Reference Chart

	Deluxe Cab Enclosure	Deluxe Cab Enclosure MAX	Clear Rigid Cab	Clear Rigid Cab MAX	Premium Rigid Cab Enclosure	Premium Rigid Cab Enclosure (Rear Glass Window with sliding panel)	Soft Cab Enclosure	Soft Cab Enclosure MAX
Kit	715007417	715007425	715007269	715007270	715008607	715006330	715008063	715008064
Windshield	715002441	715002441	715002942	715002942	715002441	715002441	715002432	715002432
Rear Window	715007080	715007080	715007081	715007081	715007079	715007080	715007081	715007081
Roof	715002430	715003038	715002430	715003038	715002430	715002430	715002430	715003038
Front Doors	715005214	715005214	715006261	715006261	715006331	715006331	715008059	715008059
Rear Doors	-	715005215	-	715006262	-	-	-	715006318
Others	715004462 715003094 715003126 715008226 715006334	715004462 715003094 715003583 715008226 715006391	715003126	715003583	710004462 715003094 715003126 715008226 715006334	710004462 715003094 715008226 715006334 715003126	-	-



# WINDSHIELDS & MIRRORS

## Windshields

### Powerflip Windshield

Traxter, Traxter MAX

715003885



- The PowerFlip Windshield is equipped with electric cylinders that allow the rider to adjust the windshield opening at the touch of a button.
- Windshield is made of hardcoated polycarbonate with a rubber seal contour and a tinted top section.
- Allows you to quickly adapt to changing conditions by adjusting the windshield as you go.

- Can be fully opened for optimal visibility and ventilation, fully closed for maximum protection from the elements, and in between, you have an infinite number of opening possibilities depending on protection, visibility and air flow preferences.
- Compatible with Can-Am roofs and windshield wiper and washer kit.

*Installation of some accessories shown may impact vehicle compliance with some regulations. Consult your local dealer for information.*

### Flip Glass Windshield

Traxter, Traxter MAX

715002942



- Curved and laminated glass full windshield in metal frame.
- Provides excellent optical clarity.
- Seals firmly against the cage and protects rider and passenger from the elements while allowing for controlled air flow.
- 3-position flip can be set at fully closed, ¼ open, or fully open.

- Gas-shock-assisted operation and pivots on 2 hinges located at the top of the windshield.
- Ideal for muddy conditions.
- Can be used with Windshield Wiper & Washer Kit (715001638).

*Installation of some accessories shown may impact vehicle compliance with some regulations. Consult your local dealer for information.*

### Flip Glass Windshield With Wiper & Washer Kit

Traxter, Traxter MAX

715002441



- Curved and laminated glass full windshield in metal frame.
- Provides excellent optical clarity.
- Seals firmly against the cage and protects rider and passenger from the elements while allowing for controlled airflow.
- Flip windshield can be set fully closed or fully open according to your preference.

- Ideal for muddy conditions.
- Gas-shock-assisted operation and pivots on 2 hinges located at the top of the windshield.
- Single-speed wiper with washer fluid dispenser.
- Requires Wiper and Power Cables: If equipped with the Sport Roof, Power Cables 710004462 & 715003094 are required. If equipped with the Audio Roof, Power Cables 715008781 & 715003094 are required.
- Not EC compliant.

*Installation of some accessories shown may impact vehicle compliance with some regulations. Consult your local dealer for information.*

### Flip Windshield – Hardcoated

Traxter, Traxter MAX

715002442



- High-impact-resistant Makrolon<sup>1</sup> hardcoated polycarbonate full windshield in metal frame.
- Provides excellent optical clarity and better abrasion resistance.
- Seals firmly against the cage and protects rider and passenger from the elements while allowing for controlled air flow.

- 3-position flip can be set at fully closed, ¼ open, or fully open.
- Gas-shock-assisted operation.
- Ideal for muddy conditions.

*Installation of some accessories shown may impact vehicle compliance with some regulations. Consult your local dealer for information.*

### Glass Windshield

Traxter, Traxter MAX

715001303



- Curved and laminated glass full windshield in metal frame.
- Seals firmly against the cage and protects rider and passenger from the elements while providing excellent optical clarity.

- Must be used with Windshield Wiper & Washer Kit (715001638) to maintain clear visibility during severe riding conditions.

*Installation of some accessories shown may impact vehicle compliance with some regulations. Consult your local dealer for information.*

### Full Windshield – Hardcoated

Traxter, Traxter MAX

715002432



- High-impact-resistant Makrolon<sup>1</sup> hardcoated polycarbonate full windshield.
- Provides excellent optical clarity and better abrasion resistance.
- Protects driver and passenger from the elements.
- Quick and easy tool-less installation or removal.

*Installation of some accessories shown may impact vehicle compliance with some regulations. Consult your local dealer for information.*

### Full Windshield

Traxter, Traxter MAX

715002431





- High-impact-resistant durable polycarbonate full windshield.
- Formulated to be non-yellowing, non-crazing, non-cracking with excellent UV resistance and optical clarity.

- Protects driver and passenger from the elements.
- Quick and easy tool-less installation or removal.

*Installation of some accessories shown may impact vehicle compliance with some regulations. Consult your local dealer for information.*



<b>Half Windshield</b>	Traxter, Traxter MAX	<b>715002433</b>
	<ul style="list-style-type: none"> <li>High-impact-resistant durable polycarbonate half windshield.</li> <li>Formulated to be non-yellowing, non-crazing, non-cracking with excellent UV resistance and optical clarity.</li> </ul>	<ul style="list-style-type: none"> <li>Protects driver and passenger from the elements.</li> <li>Features reverse angle lip to deflect air flow.</li> <li>Quick and easy tool-less installation or removal.</li> <li>Not compatible with Soft Doors.</li> </ul>
<i>Installation of some accessories shown may impact vehicle compliance with some regulations. Consult your local dealer for information.</i>		

<b>ProVent Windshield</b>	Traxter, Traxter MAX	<b>715005276</b>
	<ul style="list-style-type: none"> <li>High-impact-resistant Quantum hardcoated polycarbonate full windshield.</li> <li>Optimal performance with Full Cab Enclosure.</li> <li>Controllable vents to manage air flow.</li> <li>Channels air into the cabin, defogs windshield, fully closes to eliminate air flow.</li> </ul>	<ul style="list-style-type: none"> <li>2 lower vents and one upper vent (pre-filter installed).</li> <li>Provides excellent optical clarity and better abrasion resistance.</li> <li>Protects driver and passenger from the elements.</li> <li>Quick and easy tool-less installation or removal.</li> <li>Not compatible with wiper kits.</li> </ul>
<i>Installation of some accessories shown may impact vehicle compliance with some regulations. Consult your local dealer for information.</i>		

<b>Windshield Wiper &amp; Washer Kit</b>	Traxter, Traxter MAX	<b>715001638</b>
	<ul style="list-style-type: none"> <li>An ideal way to keep your windshield clear in rain, or while riding through mud and water.</li> <li>Includes single-speed wiper, washer fluid dispenser and windshields frame mount.</li> <li>Must be used with the Glass Windshield (715001303) or Flip Glass Windshield (715002942) or Powerflip Windshield (715003885).</li> </ul>	<ul style="list-style-type: none"> <li>Requires Wiper and Power Cables: If equipped with the Sport Roof, Power Cables 710004462 &amp; 715003094 are required. If equipped with the Audio Roof, Power Cables 715008781 &amp; 715003094 are required.</li> <li>Not EC compliant.</li> </ul>
<i>Installation of some accessories shown may impact vehicle compliance with some regulations. Consult your local dealer for information.</i>		

<b>Wiper &amp; Power Window Cable</b> <i>(Not illustrated)</i>	Traxter, Traxter MAX	<b>715008781</b>
<ul style="list-style-type: none"> <li>Required to install the Audio Roof (715005206 or 715006879) with the following accessories: Flip Glass Windshield with Wiper &amp; Washer Kit (715002441), Windshield Wiper &amp; Washer Kit (715001638), Front Full Doors with Power Windows (715006331).</li> </ul>		

<b>Wiper &amp; Power Windows Cable</b> <i>(Not illustrated)</i>	Traxter, Traxter MAX	<b>710004462</b>
<ul style="list-style-type: none"> <li>Required to install Full Doors with Power Windows (715006331) and/or Windshield Wiper &amp; Washer Kit (715001638).</li> <li>Necessary if you want to build your own cab enclosure from modular components.</li> </ul>		

<b>NEW Manual Wiper Kit</b>	Traxter, Traxter MAX	<b>715008755</b>
	<ul style="list-style-type: none"> <li>Single manual wiper that can be used to clear windshield of debris.</li> <li>Easy to install system that requires no electrical hookup.</li> <li>Large ergonomic handle provides a good grip over the entire sweeping surface.</li> <li>Compatible with glass and hardcoated windshields that use top mounted wipers.</li> </ul>	
<i>Installation of some accessories shown may impact vehicle compliance with some regulations. Consult your local dealer for information.</i>		

<b>Side Wind Deflectors</b>	Traxter, Traxter MAX	<b>715005081</b>
	<ul style="list-style-type: none"> <li>Clear polycarbonate air deflectors mount on each side of the cage.</li> <li>Not compatible with Full Doors.</li> <li>Sold in pairs.</li> <li>Compatible with all windshields.</li> </ul>	<ul style="list-style-type: none"> <li>Can be adjusted at three different positions for cabin air flow control when a full windshield is installed: <ol style="list-style-type: none"> <li>Outside deflection to reduce cabin air flow and turbulence.</li> <li>Inside deflection to increase air flow in the cabin.</li> <li>Windshield ventilation to reduce fog.</li> </ol> </li> </ul>

## Mirrors

<b>Side Mirrors</b>	Traxter, Traxter MAX	<b>715008100</b> - Black
	<ul style="list-style-type: none"> <li>Rugged black nylon 6/6 construction with coated cast-aluminum mount.</li> <li>Dual adjustment (horizontal and vertical) will suit any rider.</li> <li>Convex optics deliver optimal field of view (FOV).</li> <li>Spring-loaded pivots let mirrors fold back completely.</li> </ul>	<ul style="list-style-type: none"> <li>Fit with and without doors and half doors.</li> <li>Sold in pairs.</li> </ul>

<b>Side Mirror</b>	Traxter, Traxter MAX (2022 & up)	<b>715008101*</b>
	Traxter, Traxter MAX (2021 & prior)	<b>715002459</b>



- Molded heavy-duty aluminum mirror.
- Stays in place on rough trails.
- Ball-joint design for steady multi-angle adjustment and outstanding vision.
- Use with or without any roof, windshield or doors.

- Not for road use.
- Fits either side.
- Sold individually.
- Not compliant with T-category.

\*Not compatible with the Half Doors (715006314 & 715006316).

<b>Rear View Mirror &amp; Camera Monitor</b>	Traxter, Traxter MAX	<b>715009410</b>
--	----------------------	------------------



- Fully waterproof rearview mirror and monitor kit.
- See exactly what you need to see with the multiple camera feeds from the rear view camera.
- This unit replaces the stock rearview mirror (the screen is integrated in the unit's replacement rearview mirror).
- The camera uses infrared light for night vision capabilities.

<b>Panoramic Center Mirror</b>	Traxter, Traxter MAX	<b>715003638</b>
--------------------------------	----------------------	------------------



- Wide-angle convex mirror.
- Offers enhanced visibility.
- Can be used with or without roof or windshield and with cab enclosures.

# REAR WIND PROTECTION

<b>Rear Glass Window with Sliding Panel</b>	Traxter, Traxter MAX (except X mr models)	<b>715007080</b>
---	---	------------------



- Made of high-strength tempered glass.
- Ideal for preventing backdraft of dust or rain in harsh environments.
- Sliding panel for enhanced ventilation.
- Quick and easy installation.

- Sport Roof (715002430 or 715003038) required for installation.
- Not compatible with Snorkel Kit.

<b>Rear Glass Window</b>	Traxter, Traxter MAX (except X mr models)	<b>715007079</b>
--------------------------	---	------------------



- Made of high-strength tempered glass.
- Ideal for preventing backdraft of dust or rain in harsh environments.
- Quick and easy installation.

- Sport Roof (715002430 or 715003038) required for installation.
- Not compatible with Snorkel Kit.

<b>Rear Polycarbonate Window</b>	Traxter, Traxter MAX (except X mr models)	<b>715007081</b>
----------------------------------	---	------------------



- High-impact-resistant polycarbonate window.
- Ideal for preventing backdraft of dust or rain in harsh environments.
- Quick and easy installation.

- Sport Roof (715002430 or 715003038) required for installation.
- Not compatible with Snorkel Kit.

<b>Rear Wind Screen</b>	Traxter, Traxter MAX	<b>715002851</b>
-------------------------	----------------------	------------------



- Full rear mesh screen reduces windshield backdraft for added cabin comfort.
- Installs quick and easily on roll cage.
- White Can-Am logo at top, to help maintain clear view.

<b>Soft Rear Window</b>	Traxter, Traxter MAX	<b>715003249</b>
-------------------------	----------------------	------------------



- Clear, flexible window made of see-through vinyl.
- Resists cold cracking to -4°F (-20°C).
- Blocks windshield backdraft or dust and rain from entering, for added cabin comfort.

- Installs quick and easily on roll cage.
- White Can-Am logo at top, to help maintain clear view.



# DOORS

## Front Deluxe Full Doors

Traxter (all model years) (except X mr models),  
Traxter MAX (all model years) (except X mr models)

**715005214**



- Premium doors made from robust polyethylene.
- Offer excellent protection from the elements.
- Easy to remove on hot and sunny days.
- Convenient integrated storage areas.
- Doors' curved design provides even more room.
- Rear-hinge wide opening for ease of ingress/egress in the cockpit.
- Power window delivers added ventilation.
- Compatible with all BRP windshields.
- Require Wiper & Power Windows Cable (710004462), Roof Power Cable (715003094) and Seal Kit (715003126).
- Color Door Trims are required (sold separately).
- Hardware to install the Door Trim is included.
- No locking system.

*Installation of some accessories shown may impact vehicle compliance with some regulations. Consult your local dealer for information.*

## Rear Deluxe Full Doors

Traxter MAX 2022 & up (models produced after  
January 18, 2021) (except X mr models)

**715005215**



- Premium doors made from robust polyethylene.
- Offer excellent protection from the elements.
- Easy to remove on hot and sunny days.
- Convenient integrated storage areas.
- Curved design provides even more room.
- Rear hinge opens wide for ease of ingress/egress in the cockpit.
- Roll-Down Window delivers added ventilation.
- Require Front Doors (715005214), Wiper and Power Window Cables (710004462), Power Cable (715003094) and Sport Roof Seal Kit (715003583).
- Color Door Trims are required (sold separately).
- Hardware to install the Door Trim is included.
- No locking system.

## Front Deluxe Half Doors

Traxter (all model years),  
Traxter MAX 2022 & up

**715007201**



- Premium color matching doors made from robust polyethylene.
- Premium fit and finish.
- Slim with interior pockets.
- Rear hinge wide opening for ease of ingress/egress in the cockpit.
- Interior and exterior handles.
- Color accent panels are required (sold separately).
- Hardware to install the Door Trim is included.

*Installation of some accessories shown may impact vehicle compliance with some regulations. Consult your local dealer for information.*

## Rear Deluxe Half Doors

Traxter MAX 2022 & up

**715007202**



- Premium color matching doors made from robust polyethylene.
- Premium fit and finish.
- Slim with interior pockets.
- Rear hinge wide opening for ease of ingress/egress in the cockpit.
- Interior and exterior handles.
- Color accent panels are required (sold separately).
- Hardware to install the Door Trim is included.

## Front Trims

Front Deluxe Full Doors & Front Deluxe Half Doors



- Customize your Traxter by adding color-matched door panels.
- Front Deluxe Full Doors (715005214) or Front Deluxe Half Doors (715007201) are required.

### Front Left Door Trim

- **705800818** · Liquid Titanium
- **705800784** · Stone Gray
- **705800810** · Oxford Blue
- **705800814** · Tundra Green
- **705800812** · Timeless Black
- **705801118** · Wildland Camo **NEW**
- **705801114** · Fiery Red **NEW**

### Front Right Door Trim

- **705800819** · Liquid Titanium
- **705800785** · Stone Gray
- **705800811** · Oxford Blue
- **705800815** · Tundra Green
- **705800813** · Timeless Black
- **705801119** · Wildland Camo **NEW**
- **705801115** · Fiery Red **NEW**

## Rear Trims

Rear Deluxe Full Doors & Rear Deluxe Half Doors



- Customize your Traxter by adding color-matched door panels.
- Rear Deluxe Full Doors (715005215) or Rear Deluxe Half Doors (715007202) are required.

### Rear Left Door Trim

- **705800832** · Liquid Titanium
- **705800820** · Stone Gray
- **705800822** · Oxford Blue
- **705800826** · Tundra Green
- **705800824** · Timeless Black
- **705801120** · Wildland Camo **NEW**
- **705801116** · Fiery Red **NEW**

### Rear Right Door Trim

- **705800833** · Liquid Titanium
- **705800821** · Stone Gray
- **705800823** · Oxford Blue
- **705800827** · Tundra Green
- **705800825** · Timeless Black
- **705801121** · Wildland Camo **NEW**
- **705801117** · Fiery Red **NEW**

## Front Clear Rigid Doors

Traxter (all model years) (except X mr models),  
Traxter MAX 2022 & up (except X mr models)

**715006261**



- Sturdy and compact steel-frame doors for a robust yet open field of view.
- Lower hardcoated polycarbonate transparent panel maximizes visibility around your unit.
- Upper portion composed of two tempered-glass sliding windows for unmatched air circulation and versatility.
- EC- and ROHVA-compliant for optimal safety, allowing you to remove the stock side protection bar for increased cabin space.
- Sealed contour allows for improved rider comfort in all weather.
- Lockable doors for peace of mind.

*Installation of some accessories shown may impact vehicle compliance with some regulations. Consult your local dealer for information.*

## Rear Clear Rigid Doors

Traxter (all model years) (except X mr models),  
Traxter MAX 2022 & up (except X mr models)

**715006262**



- Sturdy and compact steel-frame doors for a robust yet open field of view.
- Lower hardcoated polycarbonate transparent panel maximizes visibility around your unit.
- Upper portion composed of two tempered-glass sliding windows for unmatched air circulation and versatility.
- EC- and ROHVA-compliant for optimal safety, allowing you to remove the stock side protection bar for increased cabin space.
- Sealed contour allows for improved rider comfort in all weather.
- Lockable doors for peace of mind.

## Half Doors

Traxter (2 doors)

**715006314**

Traxter MAX (4 doors)

**715006316**



- Half doors made of plastic.
- Metal frame for a higher level of fit and finish and rigidity.
- Rear hinge wide opening for ease of ingress/egress in the cockpit.
- Interior pockets and liners for more protection.

*Installation of some accessories shown may impact vehicle compliance with some regulations. Consult your local dealer for information.*

## Soft Doors

Traxter, Traxter MAX (all model years)

**715008059** · 2 front doors

Traxter MAX 2018 & prior,  
Traxter MAX 2022 & up (models produced after  
January 18, 2021)

**715006318** · 2 rear doors



- Bestop designed soft doors for Can-Am Traxter.
- Weather-resistant soft doors reinforced with steel frame offer good protection from the elements.
- Made of heavy-duty UV-resistant canvas for excellent resistance to tear and abrasion.
- Rear hinge wide opening for ease of ingress/egress.
- Zip-down windows made of laminated polished vinyl material for added ventilation.
- Easily removable on hot sunny days.
- Compatible with roofs and mirrors.
- Soft Door Installation Kit (715006238/2X for MAX) is required for installation of 2019 & prior doors, on 2020 Traxter models.

*Installation of some accessories shown may impact vehicle compliance with some regulations. Consult your local dealer for information.*



# SEAT ACCESSORIES

## Central Headrest

Traxter, Traxter MAX

715005163



- Headrest for front-center-seating position on 3-seated models and for rear-center-seating position on MAX models.
- Front Headrests are available separately for front passengers on MAX models.
- Headrests are required for all passengers on some regulated trails.
- Not EC compliant.

*Headrests are required for all passengers on some regulated trails.*

## Front Headrests

Traxter MAX

715005164

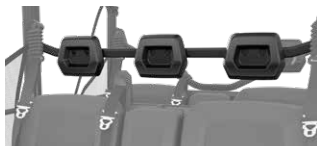

- Additional headrest for all three front-seating positions on MAX models.
- Central Headrest is available separately for rear-center-seating positions on MAX models.
- Headrests are required for all passengers on some regulated trails.
- Not EC compliant.

*Headrests are required for all passengers on some regulated trails.*

# ALUMINUM SKID PLATES

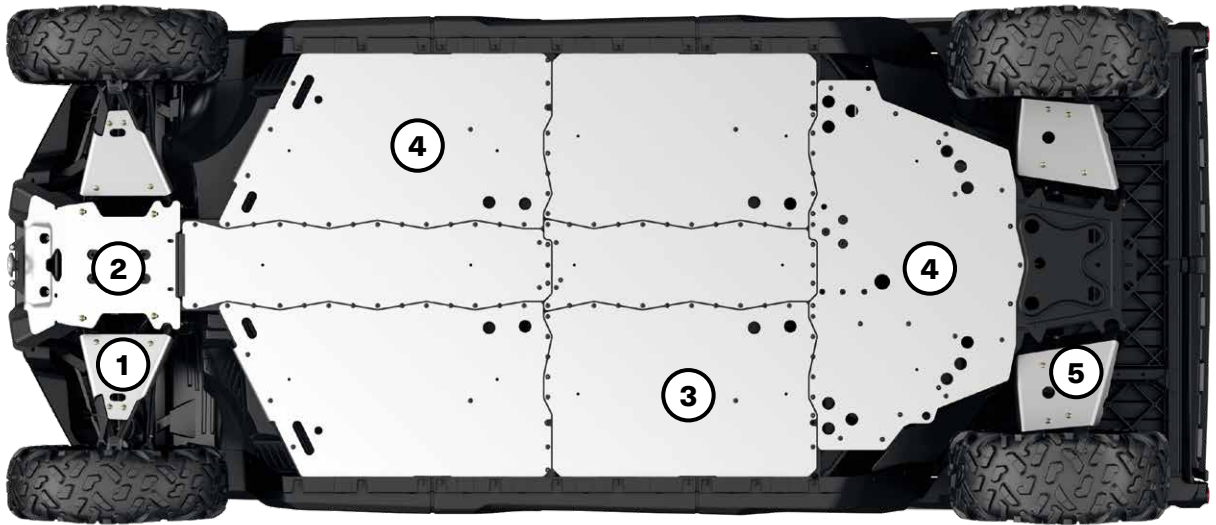

For ultimate durability and strength, all our Aluminum Skid Plates are made with High Strength 5052 H32 Aluminum  $\frac{3}{16}$ " (4.5 mm) thick.

- Ultimate durability
- High strength

## TRAXTER, TRAXTER MAX

	2019 & prior		2020 & up		
Offer your Traxter the full protection kit or get parts individually	Base, DPS, XT, XT-P, XT Cab 2017 & prior & Hunting Edition	XT Cab 2018-2019, Lone Star Edition & X mr	62" Base, DPS (HD5, HD7, HD8, HD9), DPS (HD10 T-cat 2020), XT (HD7, HD8, HD9), PRO T-cat 2020 (HD8, HD10), XU (HD7 T-cat), PRO (HD8)	64" PRO (DPS, XT) or 6x6 (DPS, XT), DPS (HD10 except T-cat 2020), XT (HD10), XT-P, XU (HD10 T-cat) 2021 & up, XU (HD9 T-cat)	67" XT Cab, Hunting Edition, Lone Star Edition, Limited, & X mr
	<b>Full Protection Kit</b>				
Aluminum Skid Plate Protection Kit	715003711 (except MAX)	715006977 (3-up)	715006694 (except MAX)	715006696 (3-up & 6x6)	715006979 (3-up 2020 to 2021 only)
	715003712 (MAX only)	715006978 (MAX)	715006695 (MAX only)	715006697 (MAX & PRO)	715006980 (MAX 2020 to 2021 only)
<b>Individual Aluminum Skid Plates</b>					
<b>1 Front A-Arm Protectors</b> <ul style="list-style-type: none"> <li>• Extra underside protection for your vehicle's steering mechanism and suspension (A-arm).</li> <li>• Sold in pairs.</li> <li>• Not compatible with Apache Track Systems.</li> </ul>	715008274	715006975	715008274	715008275	715008275 (2022 & up) 715006975 (2020 to 2021 only)
<b>2 Front Skid Plate</b> <ul style="list-style-type: none"> <li>• Protects the front underside of your vehicle when riding in rough terrain conditions.</li> <li>• Adds style to the front of your vehicle.</li> </ul>	715002447	715002447	715002447	715002447	715002447
<b>3 Central Skid Plate</b> <p>Central Skid Plate Kit includes central and lateral skid plates.</p> <ul style="list-style-type: none"> <li>• Ultra-durable protection for the underside of your vehicle.</li> <li>• Makes work easy in more demanding terrain.</li> <li>• Must be used with Underbelly Skid Plate Kit.</li> </ul>	715003467 (MAX only)	715003467 (MAX only)	715003467 (MAX only)	715003467 (MAX only)	715003467 (MAX only)
<b>4 Underbelly Skid Plate Kit</b> <ul style="list-style-type: none"> <li>• Ultra-durable protection for the underside of your vehicle.</li> <li>• Makes work easy in more demanding terrain.</li> <li>• Kit includes central, lateral and rear skid plates.</li> </ul>	715002446	715002446	715007982	715007982	715007982
<b>5 Rear A-Arm Protectors</b> <ul style="list-style-type: none"> <li>• Extra underside protection for your vehicle's suspension (A-arm).</li> <li>• Sold in pairs.</li> <li>• Not compatible with Apache Track Systems.</li> </ul>	715002445	715006976	715002445	715004388	715004388 (2022 & up) 715006976 (2020 to 2021 only)



# BUMPERS & GUARDS

## Bumpers

<b>Front Bumper</b>	Traxter, Traxter MAX (2019 & prior)	<b>715002418</b>
	Traxter, Traxter MAX (2020 & up)	<b>715005754</b>



- Heavy-duty 1.5" (3.8 cm) diameter steel-tube construction.
- Provides enhanced protection.
- Inside and outside anti-corrosion coating with durable powder coat finish.
- Integrated mounting points for lights.
- Required to install the Xtreme Front Bumper Plates, Front Rack and the Front Corner Protectors.

<b>Xtreme Front Bumper Plates</b>	Traxter, Traxter MAX (2019 & prior) <sup>†</sup>	<b>715003005</b>
	Traxter, Traxter MAX (2020 & up) <sup>‡</sup>	<b>715005777</b>



- Made of high-strength heavy-gauge steel with rubber pads for increased protection.
- Inside and outside anti-corrosion coating with durable powder coat finish.
- Provide additional front-end protection.
- Not compliant with T-category.

<sup>†</sup>Require Front Bumper (715002418) for installation.  
<sup>‡</sup>Require Front Bumper (715005754) for installation.

<b>Front Corner Protectors</b>	Traxter, Traxter MAX (2019 & prior) <sup>†</sup>	<b>715002833</b>
	Traxter, Traxter MAX (2020 & up) <sup>‡</sup>	<b>715005774</b>



- Heavy-duty 1.25" (3.2 cm) diameter steel-tube construction.
- Provide enhanced protection for front corners.
- Inside and outside anti-corrosion coating with durable powder coat finish.
- Sold in pairs.

<sup>†</sup>Require Front Bumper (715002418) for installation.  
<sup>‡</sup>Require Front Bumper (715005754) for installation.

<b>Rancher Front Bumper</b>	Traxter, Traxter MAX	<b>715005410</b>
-----------------------------	----------------------	------------------



- The low front-end protection and plates allow you to use your vehicle within cattle herds and guard the safety of both the vehicle and the animals.
- The flat front portion facilitates gently prodding cattle or pushing light objects, e.g., closing a fence.
- The full frontage coverage extends to provide an extra layer of defense to your headlights and radiator.
- Inside and outside anti-corrosion coating with durable powder coat finish.
- Traxter, Traxter MAX (2020 & up)
- Improved approach angle.
- Compatible with front rack, snow plows, tire and track kits, winches.
- Not compliant with T-category.

<b>XT Front Bumper</b>	Traxter, Traxter MAX (2019 & prior)	<b>715004407</b>
------------------------	-------------------------------------	------------------



- 1.5" (3.8 cm) diameter steel-tube construction.
- Provides light-duty protection.
- Inside and outside anti-corrosion coating with durable powder coat finish.
- Light-kit compatible.
- Standard on XT and XT Cab models 2018 and 2019.
- Not compatible with Xtreme Front Bumper Plates, Front Corner Protectors or LinQ Front Rack.

<b>X mr Front Bumper</b>	Traxter, Traxter MAX	■ <b>715006143</b> - Black
--------------------------	----------------------	----------------------------



- Heavy-duty 1.5" (3.8 cm) diameter steel-tube construction.
- Inside and outside anti-corrosion coating with durable finish.
- Provides additional front body protection.
- Integrated winch support plate for winch relocation at a higher position for easier access in muddy conditions or for auxiliary lights.
- Includes a front tow hook.
- Standard on X mr models.
- Winch sold separately.

## Cargo Bed Protectors & Tie Rails

Traxter 6x6 & PRO models

**715005415**

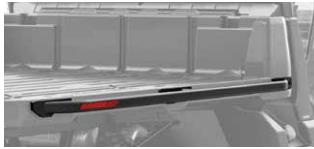

- Heavy-duty 1.5" (3.8 cm) diameter steel-tube construction.
- Reliable cargo box protection and tie-down attachment point to secure large loads.

- Anti-corrosion coating with durable powder coat finish.
- Designed to stay in place when cargo bed side walls are removed.

## Rear Bumper

Traxter, Traxter MAX

**715008109**



- Heavy-duty 1.5" (3.8 cm) diameter steel construction and integrated tubular design.
- Increased protection of rear box and lower box corner while allowing normal tailgate function.

- Inside and outside anti-corrosion coating with durable powder-coat finish.
- Required to install Rear Body Side Protector (715003055).

## Rear Bumper Adapter

*(Not illustrated)*

Traxter 6x6 & PRO models

**715006060**

- Required to install the Rear Bumper on Traxter models with the long box.

## Rear Body Side Protectors

Traxter, Traxter MAX (except 6x6 & PRO)

**715003055**



- Heavy-duty 1.5" (3.8 cm) diameter steel-tube construction.
- Reliable cargo box protection.
- Inside and outside anti-corrosion coating with durable powder coat finish.

- Compatible with fender flares.
- Integrated brush and low-lying branch deflector.
- Require Rear Bumper for installation.
- Sold in pairs.

## Body Side Protectors

### Front Body Side Protectors

Traxter, Traxter MAX

**715003450**



- Heavy-duty 1.25" (3.2 cm) diameter steel-tube construction.
- Front side protection for farm, ranch and forestry applications.
- Offer complete front body protection.
- Inside and outside anti-corrosion coating with durable powder coat finish.

- Sold in pairs.
- Require Front Bumper (715002418 or 715005754) with Front Corner Protectors (715002833 or 715005774) and Rock Slider (715002569 or 715003040 for MAX models) for installation.

### Front Rancher Body Side Protectors

Traxter, Traxter MAX

**715003617**



- Heavy-duty 1.25" (3.2 cm) diameter steel-tube construction.
- Front side protection for farm, ranch and forestry applications.
- Offer complete front body protection.

- Inside and outside anti-corrosion coating with durable powder coat finish.
- Sold in pairs.
- Require Rancher Bumper and Rock Sliders for installation.



## Fender Flares

<b>Fender Flares</b>	Traxter (except 6x6 & PRO), Traxter MAX	<b>715006821</b>
	Traxter 6x6	<b>715005409</b>
	Traxter PRO	<b>715006001</b>

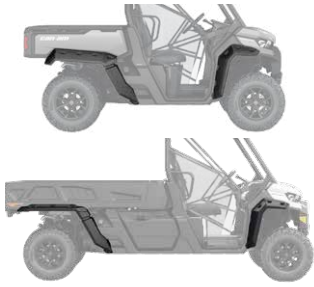

- Robust injection-molded polypropylene construction.
- Perfect for keeping mud and debris outside the vehicle.
- Include front and rear extension, and all mounting hardware.
- Ideal for track equipped vehicles.

## Sport Fender Flares

Traxter (except 6x6 & PRO), Traxter MAX	<b>715003898</b>
---	------------------



- Sleek fender flares just the right size to reduce mud and debris kick-up from your tires.
- Robust injection-molded polypropylene construction.
- Include front and rear extension, and all mounting hardware.

## Rock Sliders

<b>Rock Sliders</b>	Traxter	■ <b>715006671</b> · Black
	Traxter MAX, Traxter PRO	■ <b>715006721</b> · Black



- Heavy-duty rock sliders made of painted 3/16" (5 mm) aluminum with an integrated step for elevated cargo box access.
- Protect vehicle's sides and undercarriage against large obstacles.
- Lodge tight up against vehicle body for better clearance from obstacles.
- Not compatible with other rock sliders.
- Sold in pairs.
- Standard on Traxter X mr, Traxter MAX X mr and Traxter XT-P models.

## Rock Sliders

Traxter, Traxter 6x6	<b>715002569</b>
Traxter MAX, Traxter PRO	<b>715003040</b>



- Protect vehicle's sides and undercarriage against large obstacles.
- Made of heavy-duty 1.5" (3.8 cm) diameter steel tubing.
- Inside and outside anti-corrosion coating with durable powder coat finish.
- Integrated step for easy cargo box access.
- Sold in pairs.

## Mud Flaps

<b>Mud Flaps</b>	Traxter, Traxter MAX	<b>715003041</b>
------------------	----------------------	------------------



- Keep mud and debris out of cargo area and protect trailer or vehicles behind you.
- Add aesthetic appeal to your vehicle.
- Made of EPDM rubber.
- Require Rear Bumper for installation.
- Sold in pairs.

# LINQ: EASY ON, EASY OFF CARGO

## TRAXTER'S LINQ ACCESSORIES

### Mounting location and requirements

<ul style="list-style-type: none"> <li>No tools needed: Quickly install and remove accessories by hand</li> <li>Equip your Can-Am for specialized tasks in no time</li> <li>Sturdy mounting system that holds up to the roughest terrain</li> </ul>	Cargo Bed (long box bed LinQ)	LinQ Cargo Rack <b>715006140</b>	Adventure Roof Rack <b>715003870 / 715004391</b>
<b>LinQ Accessories with 16" Base</b> <ul style="list-style-type: none"> <li>LinQ anchors mounted 16 inches apart, center-to-center.</li> <li>Lower loading capacity than the LinQ with 36" base accessories.</li> <li>Can be used on Can-Am ATV and SxS vehicles, Can-Am Spyder and Ryker vehicles, Sea-Doo watercraft and Ski-Doo snowmobiles.</li> </ul>			
<b>LinQ 4.2 Gal Cooler</b> 295100698 • White 219400964 • Black	LinQ Base Installation Kit <b>715008125</b>	LinQ Base Installation Kit <b>715008125</b>	No compatibility
<b>LinQ Tool Kit</b> 715006829		No further requirements	No further requirements
<b>LinQ Tool Box</b> 715008111			
<b>LinQ SR 5.5 Gal (21 L) Bag</b> 860202449			
<b>LinQ 4.5 Gal (17 L) Sport Bag</b> 860202447			
<b>LinQ Modular Box</b> 715005494 • (10 L) 715007112 • (20 L) 715006830 • (30 L)			
<b>LinQ Roll-Top Bag</b> 715008110	No compatibility		
<b>LinQ Accessories with 36" Base</b> <ul style="list-style-type: none"> <li>Mount on LinQ racks often used by Can-Am ORV vehicles.</li> <li>Higher loading capacity than the LinQ with 16" base accessories.</li> <li>Usage is limited to Can-Am ORV vehicles.</li> </ul>			
<b>LinQ 12 Gal (45 L) Cargo Box</b> 715003879	No compatibility	No further requirements	No further requirements
<b>LinQ 23 Gal (86 L) Trunk Box</b> 715004923			
<b>LinQ 11.5 Gal (43 L) Audio Cargo Box</b> 715003018			
<b>LinQ 8 Gal (30 L) Cooler Box</b> 715004778 • Black 715004698 • Gray			No compatibility
<b>LinQ Premium Storage Bag by OGIO<sup>®</sup></b> 715002923 • Black			No further requirements
<b>LinQ Heavy Duty Basket</b> 715001215			
<b>LinQ Low Profile Basket</b> 715004282			
<b>LinQ Holders</b>			
<b>LinQ Gear Grips</b> 715005340	No further requirements	No further requirements	Side wall installation LinQ Adapters <b>715003058</b>
<b>LinQ Tool Holder</b> 715007358			



## LinQ Accessories with 16" Base

### LinQ Modular Box

Traxter, Traxter MAX

715005494 · (10 L)

715007112 · (20 L)

715006830 · (30 L)



- Allows stacking of other modular boxes to always have the right gear accessible.
- Always have the right box size to fit everything.
- Can be installed on any LinQ base with a 16" width.
- See table for installation location and requirements.

### Thermal Insert for LinQ Modular Box (10 L)

Traxter, Traxter MAX

219401110



- Insulated liner.
- Fits very well in the LinQ Modular Box (10 L).
- Can contain seven 355 ml cans.
- Keeps ice cold for one day.
- Interior dimensions: 9" L x 17" W x 2½" H.

### LinQ Tool Box

Traxter, Traxter MAX

715008111



- High precision injected HDPE construction provides rigidity and durability.
- 5 gal (19 L) maximum capacity.
- Weather-resistant, sealed and lockable cover.
- Easy one-second on/off tool-less system.
- All the benefits of LinQ—simple, fast and secure.
- See table for installation location and requirements.

### LinQ Tool Kit

Traxter, Traxter MAX

715006829



- Includes:
  - Cutter pliers
  - Long-nose pliers
  - Locking pliers
  - Ratchet wrench ¾" drive
  - 6" ratchet extension
  - Integrated CVT belt storage location (belt not included)
  - Long-socket 19 mm ¾" drive - 6 pts
  - Socket 18 mm ¾" drive
  - Long-socket 17 mm ¾" drive - 6 pts
  - Socket 15 mm ¾" drive
  - Socket 13 mm ¾" drive
  - Socket 10 mm ¾" drive
  - Socket 8 mm ¾" drive
  - Combined wrench 19 mm
  - Combined wrench 18 mm
  - Combined wrench 15 mm
  - Combined wrench 13 mm
  - Combined wrench 10 mm
  - Combined wrench 8 mm
  - Socket Torx<sup>†</sup> T40 ¾" drive
  - Socket Torx T30 ¾" drive
  - Socket Torx T20 ¾" drive
  - Breaker bar ¾" drive
- See table for installation location and requirements.

### LinQ 4.2 Gal (16 L) Cooler

Traxter, Traxter MAX

■ 219400964 · Black  
■ 295100698 · White



- All the benefits of LinQ—simple, fast and secure.
- Rotomolded construction for exceptional rigidity and durability.
- Premium-quality foam insulation for optimal ice retention.
- Uses LinQ mounting system (Patent US 8777531 and US 8875830).
- Easy one-second on/off tool-less system.
- Can contain twenty 355 ml cans.
- Keeps ice cold for three days.
- Exterior dimensions: 13" L x 20" W x 10" H.
- Interior dimensions: 9" L x 17" W x 7" H.
- See table for installation location and requirements.

### LinQ SR 5.5 Gal (21 L) Bag

Traxter, Traxter MAX

860202449



- Semi-rigid expandable bag.
- 5.5 gal (21 L) capacity.
- See table for installation location and requirements.

### LinQ 4.5 Gal (17 L) Sport Bag

Traxter, Traxter MAX

860202447



- 4.5 gal (17 L) capacity.
- Rigid bottom, semi-rigid top.
- See table for installation location and requirements.

<b>LinQ Roll-Top Bag</b>	Traxter, Traxter MAX	<b>715008110</b>
--------------------------	----------------------	------------------



- Fully waterproof roll-top dry bag will securely store and confine your equipment.
- LinQ mounted using heavy-duty rigid plastic base.
- High capacity storage solution (40 L).
- Bottom foam liner for additional equipment protection.
- Integrated handle for easy transportation on/off the vehicle.
- Dimensions: 14" L x 19" W x adjustable H.
- See table for installation location and requirements.

<b>LinQ Explorer Bag</b>	Traxter, Traxter MAX	<b>295101016</b>
--------------------------	----------------------	------------------



- 26 gal (100 L) of watertight storage.
- Installs in seconds with toolless LinQ accessory system.
- Dedicated essentials compartment for registration, license, insurance and more.
- Exclusive D.E.S.S. key storage.
- External quick-access pocket for small items like keys and wallets.
- Turns into a backback when you get off your machine.
- Collapsible if not fully packed with straps on both sides.
- Requires LinQ Multi Cargo Rack for installation.
- Dimensions: 26" L x 18" W x 14" H.

## LinQ Accessories with 36" Base

<b>LinQ 12 Gal (45 L) Cargo Box</b>	Traxter, Traxter MAX	<b>715003879</b>
-------------------------------------	----------------------	------------------



- Holds cargo safely and securely while riding.
- See table for installation location and requirements.

<b>LinQ 23 Gal (86 L) Trunk Box</b>	Traxter, Traxter MAX	<b>715004923</b>
-------------------------------------	----------------------	------------------



- Lockable and weather-resistant.
- Holds cargo safely and securely while riding.
- See table for installation location and requirements.

<b>LinQ 11.5 Gal (43 L) Audio Cargo Box</b>	Traxter, Traxter MAX	<b>715003018</b>
---	----------------------	------------------



- An affordable and quick solution for adding music and storage to your next ride.
- The rear installation does not use up any cab space and allows easy listening at an average speed.
- Mounts on/off easily to hold/carry cargo safely and securely.
- The Bluetooth enabled receiver and 6.5" (16.5 cm) speakers are smartly concealed and integrated in the cover.
- Automatic shut-off function protects your battery by turning the system off after 10 minutes of inactivity.
- Backlit control panel perfect for night riding.
- Water-resistant speakers.
- See table for installation location and requirements.

<b>LinQ 8 Gal (30 L) Cooler Box</b>	Traxter, Traxter MAX	<span style="display: inline-block; width: 10px; height: 10px; background-color: gray; border: 1px solid black;"></span> <b>715004698</b> · Gray <span style="display: inline-block; width: 10px; height: 10px; background-color: black; border: 1px solid black;"></span> <b>715004778</b> · Black
-------------------------------------	----------------------	--



- Installs without vehicle modification.
- Rotomolded construction provides exceptional rigidity and durability.
- Premium-quality foam insulation for optimal ice retention.
- Integrated, fully removable compartment protects food.
- Robust rubber latches keep the cover tightly closed.
- Weather-resistant.
- Convenient drain plug.
- See table for installation location and requirements.

<b>LinQ Premium Storage Bag by OGIO</b>	Traxter, Traxter MAX	<span style="display: inline-block; width: 10px; height: 10px; background-color: black; border: 1px solid black;"></span> <b>715002923</b> · Black
---	----------------------	--



- 17.2 gal (65 L) capacity semi-rigid cargo bag ideal for carrying anything you need on your vehicle.
- Buckle and elastic closure with a rubber seal that protects dust from entering the bag.
- 3-section lid for partial or full access to your bag.
- Inside separators for optimal bag organization.
- See table for installation location and requirements.



### LinQ Heavy-Duty Basket

Traxter, Traxter MAX

715001215



- Made of high-strength, low-alloy steel.
- See table for installation location and requirements.

### LinQ Low Profile Basket

Traxter, Traxter MAX

715004282



- Low profile, open basket increases cargo space.
- Perfect for easy access to tools, rope, winch and plow accessories.
- Multiple bungee cord and tie-down anchor points.
- Made of impact-resistant injected polypropylene.
- See table for installation location and requirements.

### LinQ Tailgate Extension

Traxter, Traxter MAX  
(except 6x6 and PRO models)

715002464

Traxter 6x6 & PRO

715005412



- Adds rear cargo capacity when the tailgate is open.
- Steel-tubing-system-style barrier mounts on top of the bed walls using the easy, tool-less LinQ system.
- Can be mounted to serve as cargo divider at different locations along the bed wall while preventing larger items from falling off the back.
- Stores neatly out of the way and offers additional cab area protection since it can be mounted upside down on the front bed wall as a mini headache rack.
- Anti-corrosion coating with durable powder coat finish.
- Not compatible with hard rear windows on Traxter MAX produced before January 2021.

### LinQ Tire Holder

Traxter (except 6x6 & PRO models), Traxter MAX

715003448



- Cargo box spare-tire holder.
- Heavy-duty steel construction.
- Inside and outside anti-corrosion coating with durable powder coat finish.
- Mounts on top of the bed walls using the easy, tool-less LinQ system.
- Compatible with Bed Wall Extender.
- Uses BRP standard wheel bolt pattern to mount tire (nuts included).
- Accommodates BRP tires up to 28" (wheel not included).
- Quickly allows installation in multiple positions thanks to the LinQ system.

### LinQ Cargo Rack

Traxter, Traxter MAX

715006140



- Strong, durable steel rack.
- Easy and tool-less installation thanks to the LinQ system.
- Allows the installation of LinQ accessories.
- 2 racks can be installed at the same time.
- Allows multi-level storage on cargo bed, accommodates 5 gal (19 L) bucket.
- Helps keep cargo securely in place.
- Multiple bungee cord and tie-down anchor points.
- Kit includes LinQ Base.
- Provides more usable space in the cargo box.
- Extends vehicle cargo options.

### LinQ Front Rack

Traxter, Traxter MAX

715006064



- Rugged looking front rack mounts on top of vehicle hood and provides additional storage.
- Heavy-duty 1.25" (3.2 cm) diameter steel-tube construction.
- Inside and outside anti-corrosion coating with durable powder coat finish.
- Flip-up configuration provides easy access to service area.
- Allows the installation of LinQ accessories (especially for use with LinQ Low Profile Basket [715004282]).
- Kit includes LinQ Base.
- Multiple bungee cord and tie-down anchor points.
- Requires Rancher Bumper (715005410) or Front Bumper (715002418 or 715005754) for installation.
- A great place to store tools while working in the field.
- Allows the installation of LinQ Low Profile Basket.

## LinQ Holders

### LinQ Tool Holder

Traxter, Traxter MAX

715007358



- Ultra-versatile tool holder.
- Convenient swivel-latch allows tools to be stored in any orientation.
- Suitable for installation onto the cargo walls, Deluxe Headache Rack, Bed Wall Extender, Adventure Roof Rack and LinQ Loadout Rack.
- If mounted on the Deluxe Headache Rack or the Bed Wall Extender, LinQ Adapter is required for installation.
- Sold in pairs.

### LinQ Gear Grips

Traxter, Traxter MAX

715005340



- Durable and flexible grips provide a custom fit for a variety of items from 1" to 4" (2.5 cm to 10 cm) in diameter.
- Heavy-duty design for carrying bows, fishing poles, rakes, farm tools and more.
- Quick-release button opens grip quickly for easy access to gear.
- Heavy-duty base system built for the toughest adventures.
- Make transporting your tools a snap by combining the Gear Grips with the LinQ system.
- 360° orientation.
- Sold in pairs.

## LinQ Mounting

### LinQ Adapter

Traxter, Traxter MAX

715003058

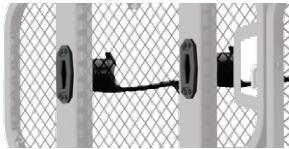

- Allows the installation of the LinQ Tool Holder to the Bed Wall Extender, Adventure roof rack or the Deluxe Headache Rack.
- Sold in pack of 4.

### LinQ Lock

Traxter, Traxter MAX

860201968



- Simple way to securely lock most LinQ accessories.
- Lock cover protects lock from the elements.
- Corrosion resistant.
- Pack of 1, includes 2 keys.
- Not compatible with LinQ 4.2 US gal (16 L) Cooler, LinQ Tool Box, LinQ Tool Holder or LinQ Gear Grips.

### LinQ Base Installation Kit

Traxter, Traxter MAX

715008125



- Unique mounting fastener usable on any LinQ system accessory.
- Included: 2 LinQ Cargo Bases and hardware.

### LinQ Replacement Part

Traxter, Traxter MAX

715001707



- Unique mounting fastener usable on any LinQ system accessory.
- Tool-less installation and removal.
- Sold in pairs.



# CARGO & STORAGE

<b>Loadout Rack</b>	Traxter, Traxter MAX	<b>715005447</b>
---------------------	----------------------	------------------



- LinQ installed versatile rack that creates a second level of storage.
- Adjustable height that goes from mid cab height to roof line.
- Modular basket adapts to different cargo with folding front and rear panels.
- Multiple hooks and holes to hang items both inside and outside the rack.
- Basket accommodates multiple LinQ positions.
- Combine with cargo net to create a hanging storage net below the basket for additional space.
- 2 racks can be installed on Traxter Pro & Traxter 6x6.

<b>Hanging Storage Box Kit</b>	Traxter, Traxter MAX	<b>715005449</b>
--------------------------------	----------------------	------------------



- Versatile rack designed to hold a standard storage box.
- Fully adjustable, the rack can be tailored to hold the crates in multiple positions: headache rack position, inside the box along the sidewall, and outside the box along the side wall.
- Includes Can-Am branded storage box.
- Exterior Cargo Reinforcement Panel is recommended when used outside of bed wall.

<b>Can-Am Storage Box</b> <i>(Not illustrated)</i>	Traxter, Traxter MAX	<b>708303237</b>
---	----------------------	------------------

- Conventional 13" x 13" plastic storage box with Can-Am branding.
- Perforated bottom allows water and debris to escape.

<b>Exterior Cargo Reinforcement Panel</b> <i>(Not illustrated)</i>		<b>715006198</b>
---	--	------------------

- Plate that attaches to the bed side to further support and protect bed wall when in outward position.
- Recommended use of the hanging storage box and/or gun and tool holder when installed outside of the bed wall (except Traxter 6x6 & PRO).

<b>Deluxe Headache Rack</b>	Traxter, Traxter MAX	<b>715002423</b>
-----------------------------	----------------------	------------------



- Protects cab components from cargo load.
- Increases box capacity when used in tandem with the Bed Wall Extender (715002421).
- Required to install the Bed Wall Extender (715002421).
- Compatible with gear rail.

<b>Headache Rack</b>	Traxter, Traxter MAX	<b>715003873</b>
----------------------	----------------------	------------------



- Full rear roll cage coverage offers a heavy-duty steel protective line of defense between your head or cab's components and the load in your cargo bed.
- Compatible with gear rail.
- Rack's open design helps maintain a clear rear view.
- Not compatible with Bed Wall Extender and Audio Roofs.

<b>Bed Wall Extender</b>	Traxter, Traxter MAX (except Traxter 6x6 & Traxter PRO)	<b>715002421</b>
	Traxter 6x6 & PRO models	<b>715005411</b>



- Increases box capacity.
- Quick and easy tool-less modularity.
- Easily removable rear door can be latched open.
- Variable full or half height settings.
- Foldable top panels come off in seconds.
- Requires Deluxe Headache Rack (715002423).

<b>Tonneau Cover</b>	Traxter 2018 & up (except Mossy Oak Break-Up Country Camo models), Traxter MAX (except 6x6 and PRO models)	<b>715008306</b>
	<ul style="list-style-type: none"> <li>• Fitted to cover all of the items in your cargo box thoroughly.</li> <li>• Prevents splash from entering the cargo box.</li> <li>• Rolls up to the front.</li> <li>• Easily removable for quick access.</li> <li>• Not compatible with accessories that exceed the box height.</li> </ul>	
<b>Removable Storage Bin</b>	Traxter, Traxter MAX	<b>715004344</b>
	<ul style="list-style-type: none"> <li>• Handy, removable on-dash tool box will make sure you have your critical equipment where you need it.</li> <li>• Provides 1.7 gal (6.3 L) of storage and clips on and off in a snap.</li> <li>• Water-resistant to ensure your contents remain safe and dry.</li> <li>• Standard on all models except Base.</li> </ul>	
<b>Removable Storage Bin – Passenger</b>	Traxter, Traxter MAX	<b>715003314</b>
	<ul style="list-style-type: none"> <li>• Convenient passenger-side underseat storage.</li> <li>• Polypropylene-injected 3.7 gal (14 L) storage capacity bin.</li> <li>• Bin installs and removes in a snap and comes with an integrated handle.</li> <li>• Water-resistant.</li> </ul>	
<b>Driver Underseat Storage Bin</b>	Traxter, Traxter MAX	<b>715003399</b>
	<ul style="list-style-type: none"> <li>• Polypropylene-injected 4 gal (15 L) capacity bin fits securely under the driver's seat.</li> <li>• Front opening for quick and easy access.</li> <li>• Ideal for storing weather-resistant items, such as ropes, tow straps and winch accessories that are needed at a moment's notice.</li> </ul>	
<b>Center Underseat Storage Bin</b>	Traxter, Traxter MAX	<b>715003446</b>
	<ul style="list-style-type: none"> <li>• Polypropylene-injected 2 gal (8 L) capacity storage bin.</li> <li>• Watertight design keeps ice and drinks cold.</li> <li>• Easy to drain and wash by removing it with integrated handle.</li> <li>• Accessible by lifting center seat section.</li> </ul>	
<b>Cargo Bed Rails</b>	Traxter (except 6x6 & PRO), Traxter MAX	<b>715003444</b>
	<ul style="list-style-type: none"> <li>• Add integrated tie-down area to your cargo box while enhancing the look.</li> <li>• Added cargo box protection.</li> <li>• Inside and outside anti-corrosion coating with durable powder coat finish.</li> <li>• Heavy-duty 1" (2.5 cm) diameter steel-tube construction.</li> <li>• Add height to the bed side wall and serve as a tie-down anchor for ropes, straps or bungees.</li> <li>• Not compatible with Bed Wall Extender and Headache Rack (715003873).</li> <li>• Sold in pairs.</li> </ul>	
<b>Cargo Bed Net</b>	Traxter (except 6x6 & PRO), Traxter MAX	<b>715003445</b>
	<ul style="list-style-type: none"> <li>• Solid net designed to hook to the bottom of the cargo box for secure and compact confinement of your cargo.</li> <li>• Keeps items tightly against the bed floor.</li> </ul>	
<b>Dash Storage Compartment Net for Heating System</b>	Traxter, Traxter MAX (2019 & prior)	<b>715003544</b>
	<ul style="list-style-type: none"> <li>• Perfect for securing items in the dash storage area.</li> <li>• To be installed when Lower Dashboard for Heating System is installed.</li> </ul>	



**Lower Dashboard for Heating System**

Traxter, Traxter MAX (2019 &amp; prior)

**715003441**

- Replaces the dashboard that comes stock with the vehicle, and features a tablet that makes it possible for driver and passenger to conveniently store small items in the dash.
- To be installed when the Defrost, Heat & Ventilation System is installed.
- Use together with the Dash Storage Compartment Net for Heating System (715003544) to prevent the items placed in the dash storage compartment from falling.

**Dash Storage Compartment Nets**Traxter, Traxter MAX  
(except Limited models)**715003129**

- Perfect for securing items in the dash storage area.
- Not compatible with Defrost, Heat & Ventilation System.
- Sold in pairs.

**Bed Tool Box**

Traxter, Traxter MAX

**715003028**

- Large 40 gal (150 L) multifunction weather-resistant tool box designed for cargo beds.
- Rotomolded construction provides exceptional rigidity and durability.
- Features cup holders and integrated groove for pipe or 2x4 cutting.
- Sized to give you the option of installing 2 tool boxes in the cargo bed (quick bolt-on installation).
- Double side openings with lockable covers and rubber latches.

**Soft Storage Bag**

Traxter, Traxter MAX

**715003759**

- 11.8 gal (45 L) capacity soft cargo bag designed with vehicle's rear in mind to maximize potential storage.
- 3 sections.
- Weatherproof.

**Backrest Rear Storage**

Traxter MAX

**715003019**

- Netting installs easily.
- Made from polyester that won't discolor.
- Sold in pairs.

**Storage 2.6 Gal (10 L) Bag**

Traxter, Traxter MAX

**269502121**

- Roll-top dry bag for fully protecting your cargo from the elements.

**NEW Passenger Storage Seat Bag**

Traxter, Traxter MAX

**715008080**

- This weather-resistant bag holds your gear safely and securely while you ride.
- Bag settling on the passenger seat to increase the vehicle's cargo capacity.
- This bag features a 14.5 gal (55 L) storage capacity and is divided into two compartments.
- The top compartment is insulated to keep your beverages cold and includes two cup holders.
- Additional pocket inside for additional storage, such as a cell phone.
- The bottom compartment is accessible from both sides and serves as a large pocket for storing various items.
- The detachable pocket at the front of the bag can be used as a garbage bag.

# RACKS & HOLDERS

## Rear Accessory Bar

Traxter, Traxter MAX

715005450



- Strong accessory bar allowing installation or hanging items off the back.
- Holes for carabiners, duck decoy hangers or other items.
- LinQ anchors allow installation of many LinQ accessories.

## Adventure Roof Rack

Traxter  
Loads of up to 40 lb (18 kg).

Traxter MAX  
Loads of up to 75 lb (34 kg).

715003870

715004391



- Ideal cargo solution for packing everything you need to live your off-road experience fully and completely.
- Built with heavy-duty 1.25" (3.2 cm) diameter steel tubing.
- Modular LinQ support plates allow for installation of most LinQ cargo accessories.
- Integrated mounting points for lights can hold up to 8 pod-type LED lights (6 front and 2 back) or a 39" (99 cm) LED bar (front)—see table for compatibility.
- Features anchor points for spare tire attachment.
- Spare Tire Tie-Downs sold separately.
- Add the Cargo Box Net or the Cargo Box Elastic Net to secure and confine your cargo in the rack.
- Not compatible with Bimini Roof or Audio Roof.

## Spare Tire Ratchet Tie-Downs

Traxter, Traxter MAX

280000955



- 3-way ratcheting tie-down strap with loop ends.
- Designed to securely hold spare tires on accessories equipped with integrated spare tire attachment points.
- Adjustable to accommodate most common UTV tire sizes.
- Ratchet and junction ring made of durable zinc-plated steel.
- Required for spare tire attachment on Adventure Roof Rack.

## LinQ Tool & Gun Holder

Traxter, Traxter MAX

715005466



- 2-in-1 holding rack can be used both on the job or on the hunt.
- Includes 5 locations to securely hold tools and guns using rubber grips and retention straps at the top and a rubber mat with gunstock shaped molding at the bottom.
- Easy to remove, install or reposition using our simple and secure LinQ system.
- Can be attached at multiple positions along the cargo bed walls, facing inside or outside the bed.
- Recommended to use with the Exterior Cargo Reinforcement Panel (715006198) when installed outside the bed wall.

## LinQ Gun Case

Traxter, Traxter MAX

715004968



- Practical design allows you to store shotguns and rifles up to 52" (132 cm) even with most optic configurations.
- Adapts to different weapon shapes and features with foam cushions that can be repositioned.
- LinQ-mounted for efficient and secure storage, locked in place with only a quarter turn.
- LinQ Gun Case Mounting Kit (715006443) is required for installation.

## LinQ Gun Case Mounting Kit

Traxter, Traxter MAX

715006443



- Required to install the LinQ Gun Case on a Traxter and Traxter MAX.
- Allows you to install up to two LinQ gun cases.
- Includes one pair.

<b>Gun Boot 6.0<sup>†</sup> Impact by Kolpin<sup>†</sup></b>	Traxter, Traxter MAX	<b>715001419</b>
--	----------------------	------------------



- Extra room for pistol-grip-type weapons and small bipods.
- Easily fits firearms up to 51" (1.3 m) in total length.
- Provides ample room for 2.4" (60 mm) scopes.
- Hatchback design allows easy access.
- Snap-close cover with locking capability.
- Ergonomically designed handle and molded attachment points for sling.
- Designed to accommodate left- and right-hand bolt-action rifles and shotguns.
- Requires Gear Rail and Gun Boot Mount by Kolpin for installation.
- Includes removable, shock-absorbing foam and nylon Impact liner for superior interior protection.
- Compatible for dual mount with additional Gun Boot Mount.

<b>Stronghold Gun Boot Impact<sup>†</sup> by Kolpin<sup>†</sup></b>	Traxter, Traxter MAX	<b>705011442</b>
---	----------------------	------------------



- Compact low-profile design with Kolpin Stronghold styling securely holds up to 52" (132 cm) long rifles and shotguns with optics.
- Includes a removable, shock absorbing foam Impact<sup>†</sup> liner.
- Single-handed opening with an attached lid for quick access along with an integrated closure strap.
- For use with the Kolpin Stronghold Auto Latch Mount System.

<b>Stronghold Auto-Latch Mount by Kolpin</b>	Traxter, Traxter MAX (except X mr models)	<b>715003899</b>
--	--	------------------



- Auto-latching design provides quick and secure gun boot attachment to your vehicle.
- Bracket is made from rugged high impact, reinforced nylon and coated steel.
- For use with Stronghold Gun Boot.
- Requires Gear Rail for Stronghold (715004089).

<b>Gear Rail for Stronghold</b>	Traxter, Traxter MAX	<b>715004089</b>
---------------------------------	----------------------	------------------

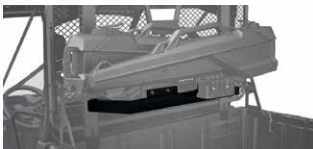

- Designed for the Stronghold Auto-Latch Mount by Kolpin.
- Can hold up to two Stronghold Gun Boots (two Latch Mounts required).
- Deluxe Headache Rack (715002423) or Gear Rail Adapter (715003392) required.

<b>Gun Boot Mount by Kolpin</b>	Traxter, Traxter MAX	<b>715001420</b>
---------------------------------	----------------------	------------------



- Fits one Kolpin Gun Boot 6.0 Impact.
- Lightweight and extremely durable.
- Easily adjustable without the use of any tools.
- Offers precision gun angle adjustability.
- Requires Gear Rail for installation.

<b>Dual Gun Holder</b>	Traxter, Traxter MAX	<b>715005265</b>
------------------------	----------------------	------------------



- Accommodates shotguns, rifles or muzzleloaders.
- Mounts in the cab, on floor board between driver and passenger.
- Rubber pads provide gun protection.
- Can be removed to allow a center passenger.
- Anti-corrosion coating with durable powder coat finish.
- Comes with all hardware for easy installation.
- Keeps your weapons within easy reach and protected within the cab area.
- Refer to your local regulations governing the transportation of firearms before purchase.

<b>Gear Rail</b>	Traxter, Traxter MAX (except X mr models)	<b>715003391</b>
------------------	--	------------------

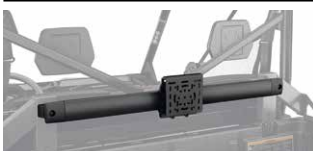

- Stationary rail system specially designed for your side-by-side vehicle.
- Universal mounting options for many Kolpin accessories like Gear Grips and Universal Saw Press.
- Rail is made with heavy-duty 7-gauge extruded anodized black aluminum.
- Mounts on roll bar.
- Includes one versatile Gear Rail Mount by Kolpin.
- Requires Deluxe Headache Rack (715002423), Headache Rack (715003873) or Gear Rail Adapter (715003392).



### Gear Rail Adapter

Traxter, Traxter MAX  
(except X mr models)

**715003392**



- Allows the installation of gear rails directly onto the cargo box without the need for a headache rack.

### Gear Rail Mount by Kolpin

Traxter, Traxter MAX

**715001422**



- Accessory bracket for mounting additional accessories to the Gear Rail.
- Includes C-clamp and metal mounting brackets.

### Double Gun Bag

Traxter (except XT Cab, X mr models),  
Traxter MAX (except XT Cab and Limited package)

■ **715003133** · Black



- Shell constructed with heavy-duty, weather-resistant polyester to shelter guns from dust and other outdoor elements, while the thick interior padding protects the guns from shocks.
- Fits perfectly on rear cage, and guns are readily accessible from both sides of vehicle.
- Design features include a removable center pocket that can be mounted on both sides of the bag, and extra front storage pockets for hunting gear.
- Solid, quick installation.
- Not compatible with rear wind protection, headache racks and gear rails.
- May interfere with the tilt function of the Traxter 6x6 or Traxter PRO models' bed.

### Universal Saw Press by Kolpin

Traxter, Traxter MAX  
(except X mr models)

**715001423**



- Specially crafted for transporting your chainsaw securely and safely aboard your side-by-side vehicle.
- Heavy-duty, black powder-coated metal bracket designed to attach any chainsaw model with up to a 20" (51 cm) bar.
- Rubber pads provide cushion and tight fit.
- Hinged design for quick removal.
- Holds saw in vertical position or 45° angle in either direction.
- Requires Gear Rail.
- Protective sheath included.

### LinQ Gear Grips

Traxter, Traxter MAX

**715001421**



- Durable, flexible grips cushion and protect while providing a custom fit for a variety of items from 1" to 4" (2.5 cm to 10 cm) in diameter.
- Heavy-duty design for carrying bows, fishing poles, rakes, farm tools and more.
- Quick-release button opens grip quickly for easy access to gear.
- Heavy-duty base system built for the toughest adventures.
- Easy installation on tubular racks, extension racks, brackets or bumpers.
- Sold in pairs.

# LIGHTS

1 Choose your mount point		2 Find your platform		3 Choose your lights				
				10" (25 cm) Double Stacked LED Bar	15" (38 cm) Double Stacked LED Bar	39" (99 cm) Double Stacked LED Bar	4" (10 cm) Round LED LIGHTS (Sold in pairs)	3.5" (9 cm) LED Lights (Sold in pairs)
<b>Front Bumper</b> <b>Rancher Bumper</b> <b>XT Front Bumper</b> <b>X mr Front Bumper</b> <i>(w/o winch)</i> <b>X-TP Front Bumper</b>	Traxter Traxter MAX 2019 & prior	<b>715002933</b> PLUS <b>715002454</b> (Light Power Cable)	<b>715002934</b> PLUS <b>715002454</b> (Light Power Cable)	N/A	<b>715002935</b> (4" Round), <b>715003665</b> (3.5" Flood) or <b>715003666</b> (3.5" Spot) PLUS <b>715002454</b> (Light Power Cable)			
	Traxter Traxter MAX 2020 & up	<b>715002933</b> PLUS <b>715006034</b> (Light Power Cable)	<b>715002934</b> PLUS <b>715006034</b> (Light Power Cable)	N/A	<b>715002935</b> (4" Round), <b>715003665</b> (3.5" Flood) or <b>715003666</b> (3.5" Spot) PLUS <b>715006034</b> (Light Power Cable)			
<b>Light Rack</b> or Light Bars <i>*Roof Power Cable and Front Roof Liner may not be required if already installed with other accessories.</i>	Traxter & Traxter MAX (except XT Cab)	<b>715002933</b> PLUS <b>715003094</b> (Roof Power Cable) & <b>715008226</b> (Front Roof Liner)	<b>715002934</b> PLUS <b>715003094</b> (Roof Power Cable) & <b>715008226</b> (Front Roof Liner)	<b>715006226</b> (Light Bar Support) PLUS <b>715004007</b> (39" Light Bar) PLUS <b>715005822</b> (Power Cable) & <b>715008226</b> (Front Roof Liner)	<b>715002935</b> (4" Round), <b>715003665</b> (3.5" Flood) or <b>715003666</b> (3.5" Spot) PLUS <b>715003094</b> (Roof Power Cable) & <b>715008226</b> (Front Roof Liner)			
	Traxter Traxter MAX XT Cab Limited	<b>715002933</b>	<b>715002934</b>	<b>715006226</b> (Light Bar Support) PLUS <b>715004007</b> (39" Light Bar) PLUS <b>715005822</b> (Power Cable)	<b>715002935</b> (4" Round), <b>715003665</b> (3.5" Flood) or <b>715003666</b> (3.5" Spot)			
<b>Adventure Roof Rack</b> <i>*Roof Power Cable may not be required if already installed with other accessories.</i>	Traxter & Traxter MAX (except XT Cab Limited)	N/A	Front only: <b>715002934</b> PLUS <b>715003417</b> (Power Cable) & <b>715003094</b> (Roof Power Cable) & <b>715008226</b> (Front Roof Liner)	Front only: <b>715004007</b> PLUS <b>715005822</b> (Power Cable) & <b>715003094</b> (Roof Power Cable) & <b>715008226</b> (Front Roof Liner)	Front or Rear: <b>715002935</b> (4" Round), <b>715003665</b> (3.5" Flood) or <b>715003666</b> (3.5" Spot) PLUS <b>715003417</b> (Power Cable) & <b>715003094</b> (Roof Power Cable) & <b>715008226</b> (Front Roof Liner)			
	Traxter, Traxter MAX XT Cab Limited	N/A	Front only: <b>715002934</b> PLUS <b>715003417</b> (Power Cable)	Front only: <b>715004007</b> PLUS <b>715005822</b> (Power Cable)	Front or Rear: <b>715002935</b> (4" Round), <b>715003665</b> (3.5" Flood) or <b>715003666</b> (3.5" Spot) PLUS <b>715003417</b> (Power Cable)			

**4 Order** **Order all part numbers in intersecting box**  
*\*Note: When installing more than one light kit, additional light power cable or mounting kit is required.*

<b>Roof Power Cable</b> <i>(Not illustrated)</i>	Traxter, Traxter MAX	<b>715003094</b>
---	----------------------	------------------

- Required for installation of some electrical accessories.
- Brings power from the battery.

<b>Light Kit Power Cable</b> <i>(Not illustrated)</i>	Traxter, Traxter MAX (2019 & prior)	<b>715002454</b>
	Traxter, Traxter MAX (2020 & up)	<b>715006034</b>

- Power cable for installation of compatible Can-Am light kits at front bumper location.

**10" (25 cm) Double Stacked LED Light Bar (60 W)**

Traxter, Traxter MAX

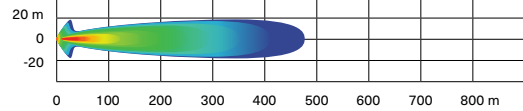
**715002933****5,400 lumens**

- Equipped with twelve 5 W Cree LEDs.
- 5,400 lumens.
- Packs a big punch for its size.
- Rugged and waterproof.
- Can be installed on front bumpers, sport roof and Bimini roof with sun visor.

- Requires light power cable for installation.
- Lights up to more than 1,500 ft (460 m) in front of the vehicle and around 65 ft (20 m) wide on each side.
- Not EC compliant.
- See table for installation location and requirements.

**15" (38 cm) Double Stacked LED Light Bar (90 W)**

Traxter, Traxter MAX

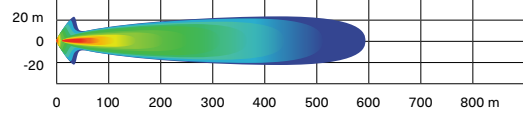
**715002934****8,400 lumens**

- Equipped with 18 5 W Cree LEDs.
- 8,400 lumens.
- Complements the Light Racks and most bumpers.
- Rugged and waterproof.

- Lights up to more than 1,900 ft (580 m) in front of the vehicle and around 65 ft (20 m) wide on each side.
- Not EC compliant.
- See table for installation location and requirements.

**39" (99 cm) Double Stacked LED Light Bar (270 W)**

Traxter, Traxter MAX

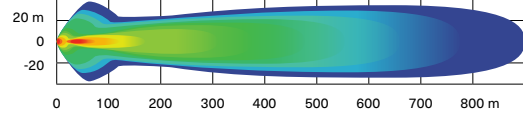
**715004007****24,300 lumens**

- Equipped with 54 5W Cree LEDs.
- 24,300 lumens.
- Lights up to more than 2,900 ft (900 m) in front of the vehicle and around 115 ft (35 m) wide on each side.

- Compatible on the Adventure Roof Rack.
- Compatible with Flip Windshields and Full Windshields.
- See table for installation location and requirements.
- Not EC compliant.

**4" (10 cm) Round LED Lights (2 x 25 W)**

Traxter, Traxter MAX

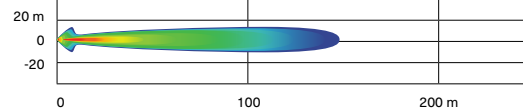
**715002935****1,800 lumens**

- 25 W LED spotlights.
- 1,800 lumens.
- Rugged and waterproof.
- Includes basic wiring and switch.
- Can-Am branded grill.

- Requires light power cable.
- Sold in pairs.
- Not EC compliant.
- See table for installation location and requirements.

**3.5" (9 cm) LED Driving Lights (2 x 14 W)**

Traxter, Traxter MAX

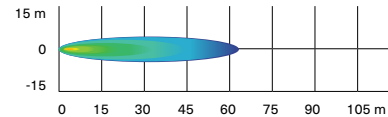
**715003666****1,260 lumens**

- 14 W LED lights producing 1,260 lumens each.
- Spot lens for a narrow and long light beam spread, ideal when driving at higher speeds.
- Equipped with six high-power LEDs in a heavy-duty die-cast aluminum housing.

- Features two attachment points. If one attachment point fails due to a collision, rotate to the next channel point and remount the light.
- Sold in pairs.
- CE certified.
- See table for installation location and requirements.



### 3.5" (9 cm) LED Flood Lights (2 x 14 W)

Traxter, Traxter MAX

715003665

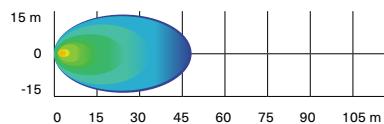

- 14 W LED lights producing 1,260 lumens each.
- Flood lens for a wide light beam spread, ideal for working applications like plowing or cornering. Suitable for dusty or foggy riding conditions.
- Equipped with six high-power LEDs in a heavy-duty die-cast aluminum housing.
- Features two attachment points. If one attachment point fails due to a collision, rotate to the next channel point and remount the light.
- Sold in pairs.
- CE certified.
- See table for installation location and requirements.

### Light Bar Support

Traxter, Traxter MAX

715006226



- Mounting Bracket that allows the installation of the Can-Am 39" Lightbar (715004007).
- Low and forward mounting position for a sleek look.
- Compatible with all windshields, roofs and doors.

### Light Rack

Traxter, Traxter MAX

715002456



- Rugged steel construction serves as both mount and protection for accessory light systems.
- Lights not included.
- Front Roof Liner is required for installation on the roof (except Cab models or with Deluxe Sport Roof).
- Power Cable, Sport Roof, Deluxe Sport Roof or Sport Roof for MAX required for installation.
- Integrates elegantly and seamlessly into our roof products.

### Rear Cargo Light

Traxter, Traxter MAX (2020 & up)

715007077



- Powerful 55W H3 illumination for rear cargo area.
- Convenient in-dash switch.
- Wiring included.
- Sport Roof (715002430) or Sport Roof for MAX (715003038) is required for installation.
- Not EC compliant.
- Not compatible with headache rack on Traxter Pro and Traxter 6x6.

### RAM<sup>†</sup> LED Spotlight

Traxter, Traxter MAX (2019 & prior)

710005423



- 540 lumen (9 watt) heavy-duty LED spotlight standard-equipped with 1" (2.5 cm) diameter rubber-coated double ball and socket system.
- Not EC compliant.

### Dome Light

Traxter, Traxter MAX

715002455



- LED array integrates perfectly with vehicle.
- Wiring included.
- Can be installed on cage or roof, with or without roof liner.
- Not compatible with Traxter Audio Roofs.

### LED Signature Lights

Traxter, Traxter MAX (2020 & up)

715006896



- The stylish LED set puts the finishing touch to your Traxter, accentuating its aggressive stance.
- Included on Limited and Lone Star models.
- Not EC compliant.

# AUDIO & COMMUNICATION SYSTEMS

## Can-Am Audio Roof

Traxter

715005206



- Full roof with sleek built-in audio.
  - Fully sealed and waterproof.
  - Easy to install: one wire connects the roof to the vehicle's electronics.
  - Four 8" speakers, one 280 watt amplifier, and one weatherproof source unit supplied by JL Audio<sup>1</sup>.
  - Speakers include LED lighting integrated into the grille, designed to uniformly illuminate with an RGB glow.
  - A 3" full-color LCD display, with separate day/night lighting themes for visibility, even in bright sunshine.
  - AM/FM tuner.
- To install the Audio Roof with the following accessories, the Power Harnesses 715003094 & 715008781 are required: Flip Glass Windshield With Wiper & Washer Kit (715002441), Windshield Wiper & Washer Kit (715001638), Front Full Doors With Power Windows (715006331), Front Deluxe Full Doors (715005214), Rear Deluxe Full Doors (715005215).
  - Not compatible with Adventure Roof Rack and Headache Rack.
  - Not compatible with 39 in. (99 cm) Double Stacked LED Light Bar (270 W) (715004007) & Light Bar Support (715006226).

## Can-Am Audio Roof MAX

Traxter MAX

715006879



- Full roof with premium JL Audio system for Traxter MAX.
  - Fully sealed and waterproof components and construction.
  - Simple to install: one connector connects the roof to the vehicle's electrical system.
  - Weatherproof components: Six 7.7" coaxial speakers, 280 watt amplifier and 70 watt Mediamaster<sup>®</sup> source unit.
  - AM/FM tuner.
  - Expertly tuned for exceptional sound on the move in your Traxter MAX.
  - Speakers include adjustable RGB LED cone illumination, controlled via an app on your smartphone.
  - Mediamaster<sup>®</sup> source unit equipped with 3" full-color LCD display, with day/night lighting modes.
- Designed to not drain the battery.
  - Specific to the type of riding.
  - To install the Audio Roof with the following accessories, the Power Harnesses 715003094 & 715008781 are required: Flip Glass Windshield With Wiper & Washer Kit (715002441), Windshield Wiper & Washer Kit (715001638), Front Full Doors With Power Windows (715006331), Front Deluxe Full Doors (715005214), Rear Deluxe Full Doors (715005215).
  - Not compatible with Adventure Roof Rack.
  - Not compatible with 39 in. (99 cm) Double Stacked LED Light Bar (270 W) (715004007) & Light Bar Support (715006226).

## Wetsound Stealth XT 6 Can-Am Edition Sound Bar

Traxter, Traxter MAX

715008282



- Built-in Bluetooth connectivity with source control.
  - Built-in Broadcast mode.
  - Backlit control panel with Integrated LED RGB cabin lights.
  - Integrated LED Dome.
  - IP67 rated RF wireless remote control.
  - 3.5 aux input/output.
  - Built-in 300 W Class D Amplifier.
- 4 marine-rated 3" full range drivers.
  - 2 marine-rated 1" tweeters.
  - Operating voltage: 12 V.
  - IP rated: IP67.
  - Length: 21.31"
  - Width: 4.04"
  - Height: 3.85"
  - Sound Bar Mounting Kit required for installation.

## Sound Bar Mounting Kit

Traxter, Traxter MAX

715007840



- Required to install the Wetsound Stealth XT 6 Can-Am Edition Sound Bar on a Traxter and Traxter MAX.

## Overhead Audio System



- Rugged waterproof Jensen<sup>1</sup> Bluetooth Stereo Audio System offers multi-source input: AM/FM/WB and USB (iPod<sup>®</sup> and iPhone<sup>®</sup> ready).
  - Convenient white LED-backlit LCD display and buttons.
  - Stream from any Bluetooth-enabled device (smartphone, MP3 player).
  - Powerful 4x40W amplifier with remote turn-on.
  - Voice-control of AVRCP-active device.
- 30 programmable AM/FM stations with auto-store/pre-set scan.
  - Separate RCA audio output and input.
  - UV-resistant finish/corrosion-resistant components.
  - Requires Sport Roof (715002430) or Front Roof Liner (715008226) and Power Cable (715003094).

## Complete Overhead Audio System

Traxter, Traxter MAX

715002019

- Complete with 4 ultra-sturdy outdoor speakers (2 front and 2 rear) and 4 black speaker boxes.

## Overhead Front Audio System

Traxter, Traxter MAX

715003095

- Complete with 2 ultra-sturdy front outdoor speakers and black speaker box.

# ELECTRONIC ACCESSORIES

## Back-Up Monitor and Camera Kit

Traxter, Traxter MAX

715003834



- Fully waterproof rear view camera and monitor kit.
- The camera is one of the clearest and sharpest available on the market, with 250,000 pixel image resolution and a 2.1 mm lens with 130° viewing angle.
- Features 18 infrared lights that allow up to 50 ft. (15.24 m) visibility in complete darkness, an auto iris sensor that adapts to light intensity changes and an adjustable sunshade.
- 7" (17.78 cm) digital TFT LCD color monitor comes with power harness and can support up to two camera inputs.
- The camera can be roof mounted to monitor your cargo load or to see farther behind, and it can be mounted under the cargo box for hitching purpose.
- Not compatible with Defrost Heat and Ventilation System or HVAC.

## Power Tilt Bed

Traxter (except 6x6), Traxter MAX  
(2020 & up), Traxter PRO  
Traxter 6x6

715007096

715007204



- Powerful cargo box tilter with dash-integrated switch.
- Electrical actuated hydraulics for a strong and quick tilting system.

## C-TEK charger

860200997



- CTEK, the manufacturer of the smartest battery chargers in the world, has produced a BRP specific charger for all BRP products.
- Charger is built to meet the demanding arctic conditions.
- Ask your dealer for more information.

## 3-Mode Switch

Traxter, Traxter MAX

715004445



- Switches quickly and conveniently between Normal / Work / Eco modes.
- Work mode: Reduced throttle sensitivity for smoother acceleration and reduced load impact.
- Eco mode: Increased fuel economy.
- In-dash plug-and-play mount.
- Standard on 2020 models.

## NEW Cellphone Holder

Traxter, Traxter MAX

715008786



- Water resistant door allows for perfect phone positioning.
- Features capacitive and resistive touch screen technology.
- Spring system in back plate automatically adjusts for thickness.
- Fits all cellphones within 7.2" (185 mm) x 3.3" (85 mm) x 0.6" (15 mm) dimensions.
- Works with almost all charger wires.
- Does not include cellphone or charging wires.
- Requires the RAM GPS Mount (715003325) bolted directly on the dashboard for the Cellphone Holder to be supported.

## RAM GPS Mount

715003325



- Allows for GPS integration onto vehicle.
- Standard AMPS hole pattern for Garmin Cradle.



**Digitally Encoded Security System (D.E.S.S.™) Keys**

Traxter, Traxter MAX (2023 &amp; prior), Traxter &amp; Traxter MAX 2024 (with HD9 &amp; HD10 engine)

**715002458**

- Top-security anti-theft protection for your vehicle.
- Encrypted chip technology restricts access to your vehicle's electronic ignition system.
- One vehicle/one code.
- A vibration/shock-resistant ball-and-socket design that ensures a reliable connection.
- 3 programmable modes:
  - Work mode: Limits vehicle speed to 40 kph (25 mph) but does not limit engine torque.
  - Normal mode: Limits vehicle speed to 70 kph (44 mph) and 50% torque reduction.
  - Performance mode: No restrictions.

**NEW Digitally Encoded Security System (D.E.S.S.™) Keys**

Traxter, Traxter MAX 2024 (with HD7 engine)

**715009300**

- Top-security anti-theft protection for Can-Am vehicles.
- The encrypted chip technology restricts access to the unit's electronic ignition system.
- One code per vehicle.
- Features a vibration/shock-resistant ball-and-socket design that ensures a reliable connection.
- Comes with three programmable keys, including:
  - Work key: configurable vehicle speed limit between 30 kph (18 mph) and maximum vehicle speed that does not limit engine torque.
  - Normal key: limits vehicle speed to 70 kph (44 mph) and 10% torque reduction on Traxter models.
  - Performance key: no restrictions.

**Auxiliary Battery Installation Kit**

Traxter, Traxter MAX (2019 &amp; prior)

**715003758**

Traxter, Traxter MAX (2020 &amp; up)

**715006035**

- Allows you to add a second 30Ah battery for that dual battery setup that will give you the extra juice you'll need to power auxiliary electrical components like a sound system or winch.
- Additional battery sold separately (515176151).
- Equipped with an integrated smart battery isolator that will prevent your auxiliary electrical components from draining your starting battery.
- Kit includes an additional battery junction block, all necessary wiring and the battery holder.

**USB Power Outlet Kit**

Traxter, Traxter MAX (2020 &amp; up)

**219400510**

- Recharges your electronic devices while riding\* (smartphone, MP3, heating gear, etc.).
- Dual port USB connectors.

*\*The power outlet is not capable of recharging all device types while riding.***Defrost, Heat & Ventilation System**

Traxter, Traxter MAX 2019 &amp; prior (not compatible with HD5 Motorization)

**715004917**

- Best integrated system on the market with 3-ventilation speed and in-dash adjustable temperature.
- Adjustable/directional vents.
- 10 vents specially positioned for better windshield and side windows defrosting/deicing, foot and hand heat.
- Easy-service air filter.
- Once installed, you might want to add storage space with the Lower Dashboard for Heating System and Dash Storage Compartment Net for Heating System.

Traxter, Traxter MAX 2020 (except Traxter PRO &amp; HD5 models)

**715005904**

Traxter, Traxter MAX (2022 &amp; up, except XU models)

**715008093**

Traxter, Traxter MAX (2022 &amp; up, XU models only)

**715008095**

Traxter, Traxter MAX (2021 except models with ABS &amp; HD5)

**715007353**

- Best integrated in-dash system on the market with 3 fan speeds and adjustable temperature.
- Adjustable/directional vents can be closed to concentrate heat at specific areas.
- A total of 8 vents specially positioned for windshield and occupant heating.
- Easy-to-service air filter.
- Includes the replacement lower dashboard compartment for the heating system.
- Dash Storage Compartment Net for Heating System is recommended.

**Heated Steering Wheel**

Traxter, Traxter MAX

**715003837**

- Ruggedly constructed steering wheel designed to withstand cold conditions while channeling heat directly to your hands.
- Perfect for making hand mobility and grip readily available, e.g., hunting, manual farming.
- Replaces stock steering wheel.
- This kit includes the heated steering and in-dash switch.
- Draws a maximum of 45 W and 3.2 A at 13.5 V.
- Heated Accessory Electrical Harness (710005757) is required on all models except XT Cab 2020 & up and PRO models, which require Heated Accessories Wiring Harness (715006036).
- Not compliant with T-category.

<b>Radiator Winter Front</b>	Traxter, Traxter MAX (2019 and prior)	<b>715005108</b>
------------------------------	---------------------------------------	------------------



- Allows you to get higher heating temperature out of the Defrost, Heat & Ventilation System in extremely cold conditions.

<b>Heated Seat</b>	Traxter, Traxter MAX	<b>715006112</b>
--------------------	----------------------	------------------



- 25 W seat heater delivers chill-free riding comfort.
- High/low temperature settings allow you to control the desired degree of warmth.
- This kit includes one carbon fiber seat heater, foam sheet and in-dash switch.
- Installs directly in the original seat cushion.
- Heated Accessories Wiring Harness (710005757) is required for installation on front seat.
- Heated Accessories Wiring Harness (715006036) is required for installation on Traxter XT Cab, PRO and Limited models.
- Heated Accessories Wiring Harness (715006004) is required for installation on rear seats on MAX models.

<b>Heated Seat Harness for MAX Model</b> <i>(Not illustrated)</i>	Traxter MAX	<b>715006004</b>
--	-------------	------------------

- Electric harness required to hook up and operate rear heated seats.

<b>Heated Visor Outlet</b>	Traxter, Traxter MAX	<b>715001246</b>
----------------------------	----------------------	------------------



- Strategically positioned on vehicle to maintain your agility.
- Optional visor outlet that delivers fog-free riding.
- Quick and easy installation.
- Sold individually.
- Heated Visor not included.

<b>Heated Accessories Wiring Harness</b> <i>(Not illustrated)</i>	Traxter, Traxter MAX (models with defrost, heat & ventilation system), All Traxter PRO models	<b>715006036</b>
	Traxter, Traxter MAX (models without defrost, heat & ventilation system)	<b>710005757</b>

- Electric harness required to hook up and operate heated accessories.
- Power up to 4 accessories: 2 hand accessories (grab bar/steering wheel) and 2 seat covers.

# WINCHES & HITCHES

## Can-Am HD Winches

<b>Can-Am HD 4500 Winch</b>	Traxter, Traxter MAX	<b>715006416</b>
-----------------------------	----------------------	------------------



- Ergonomic clutch handle.
- Rugged all-steel gears and bushings for more torque and durability.
- Automatic 100% load-holding brake.
- Sealed solenoid for all-weather protection.
- Weather sealed corded remote and dash mounted switch.
- EC compliant.
- Pulling strength capability of 4,500 lb (2,041 kg).
- 43' of  $\frac{1}{8}$ " (13.1 m of 6.3 mm) wire steel cable.
- Heavy-duty 4-way roller fairlead.
- Winch Electrical Harness (715007078) is required for installation on a Traxter 2021 and prior. Winch Electrical Harness (715008152) is required for installation on a Traxter Base and DPS 2022 & up.

<b>Can-Am HD 4500-S Winch</b>	Traxter, Traxter MAX	<b>715006417</b>
-------------------------------	----------------------	------------------



- Ergonomic clutch handle.
- Rugged all-steel gears and bushings for more torque and durability.
- Automatic 100% load-holding brake.
- Sealed solenoid for all-weather protection.
- Weather sealed corded remote and dash mounted switch.
- Pulling strength capability of 4,500 lb (2,041 kg).
- 50' of  $\frac{1}{4}$ " (15.2 m of 6.35 mm) synthetic rope.
- Corrosion-proof aluminum hawse fairlead.
- Winch Electrical Harness (715007078) is required for installation on a Traxter 2021 and prior. Winch Electrical Harness (715008152) is required for installation on a Traxter Base and DPS 2022 & up.

# WARN<sup>+</sup> VRX Winches

## WARN VRX 45 Winch

Traxter, Traxter MAX  
(except XT Cab 2018-2019, Lone Star Edition, X mr,  
Limited, DPS Cab & Hunting Edition 2020 & up)

**715006110**



- Extreme IP68-rated waterproof sealing keeps the elements out.
- Durable all-metal construction.
- Black powder-coated finish and stainless steel fasteners for corrosion resistance.
- Robust new clutch design based on 70+ years of WARN 4 WD hub lock know-how.
- Load-holding brake for great control.
- Smooth and reliable all-metal three-stage planetary gear train.
- Dash-mounted rocker control.
- Limited lifetime warranty (mechanical), 3-year warranty (electrical).
- Pulling strength capability of 4,500 lb (2,041 kg).
- 50' of ¼" (15 m of 6.3 mm) wire steel cable.
- Roller fairlead.
- Winch Electrical Harness (715007078) is required for installation on a Traxter 2021 and prior. Winch Electrical Harness (715008152) is required for installation on a Traxter 2022 & up.

## WARN VRX 45-S Winch

Traxter, Traxter MAX  
(except XT Cab 2018-2019, Lone Star Edition, X mr,  
Limited, DPS Cab & Hunting Edition 2020 & up)

**715006111**



- Extreme IP68-rated waterproof sealing keeps the elements out.
- Durable all-metal construction.
- Black powder-coated finish and stainless steel fasteners for corrosion resistance.
- Robust new clutch design based on 70+ years of WARN 4 WD hub lock know-how.
- Load-holding brake for great control.
- Smooth and reliable all-metal three-stage planetary gear train.
- Dash-mounted rocker control.
- Limited lifetime warranty (mechanical), 3-year warranty (electrical).
- Pulling strength capability of 4,500 lb (2,041 kg).
- 50' of ¼" (15 m of 6.3 mm) synthetic rope.
- Cast aluminum hawse fairlead.
- Winch Electrical Harness (715007078) is required for installation on a Traxter 2021 and prior. Winch Electrical Harness (715008152) is required for installation on a Traxter 2022 & up.

## Cargo Bed Winch

Traxter, Traxter MAX

**715006355**



- Allows you to pull heavy loads into the cargo box easily.
- Perfect for hunting applications, i.e., loading game.
- Includes support base made of heavy-duty 2" (5 cm) steel tubing, winch and weather-sealed corded remote.
- 750 lb (340 kg) maximum pulling capacity.
- Electronic security module to prevent vehicle damage that could occur if loaded vehicle exceeds manufacturer's gross weight rating.
- Adapter Kit (715004709) required for installation with Gear Rail Adapter.
- Requires Powertilt bed for Traxter 6x6 and PRO.
- Not CE certified.
- Not available in Europe.

## Synthetic Winch Cable\*

With WARN winch

**715007783**



- 50' of ¼" (15.2 m of 6.35 mm) synthetic cable for WARN winch.
- WARN Hawse Fairlead is required when upgrading to a synthetic cable to avoid damage and premature wear of the cable.

*\*Ask your dealer or visit [canamoffroad.com](http://canamoffroad.com) for price details.*

## Synthetic Winch Cable\*

With Can-Am HD winch

**715006430**



- 50' of ¼" (15.2 m of 6.35 mm) synthetic cable for Can-Am HD winches.
- Hawse Fairlead (715006426) required when upgrading to a synthetic cable to avoid premature cable damage and wear.

*\*Ask your dealer or visit [canamoffroad.com](http://canamoffroad.com) for price details.*

## Synthetic Cable Extension

**715001120**



- Lightweight ¼" (6.35 mm) diameter, easy to handle and won't rattle in cargo box.
- Easily attaches to winch cable to provide additional 50' (15.2 m) of distance.
- 4,500 lb (2,041 kg) single line capacity.



<b>Replacement Wire Rope*</b>	With WARN winch	<b>715006699</b>
	<ul style="list-style-type: none"> <li>• 55' of 1/4" (16.8 m of 6.35 mm) wire rope for WARN winch kit.</li> <li>• 4,500 lb (2,041 kg) pulling strength.</li> </ul> <p><i>*Ask your dealer or visit <a href="http://canamoffroad.com">canamoffroad.com</a> for price details.</i></p>	
<b>Replacement Wire Rope*</b>	With Can-Am HD winch	<b>705014978</b>
	<ul style="list-style-type: none"> <li>• 43' of 1/8" (13.1 m of 6.3 mm) wire rope.</li> <li>• 4,500 lb (2,041 kg) pulling strength.</li> </ul> <p><i>*Ask your dealer or visit <a href="http://canamoffroad.com">canamoffroad.com</a> for price details.</i></p>	
<b>WARN Hawse Fairlead*</b>	With WARN winch	<b>715007785</b>
	<ul style="list-style-type: none"> <li>• Double-powder-coated construction.</li> <li>• Required to use the Synthetic Winch Cable (715007783) on WARN winches.</li> <li>• To be used with synthetic winch cables only.</li> </ul>	
<b>Can-Am HD Hawse Fairlead</b>	With Can-Am HD winch	<b>715006426</b>
	<ul style="list-style-type: none"> <li>• A must when upgrading your winch with a synthetic cable, this corrosion-proof aluminum hawse fairlead will prevent the cable from snapping in a corner of a roller fairlead and from wearing prematurely due to the rough surface of the worn roller guide.</li> <li>• Must be used with synthetic cables only.</li> </ul>	
<b>Roller Fairlead</b>	With Can-Am HD winch	<b>710007082</b>
	<ul style="list-style-type: none"> <li>• Suggested when changing the wire rope.</li> <li>• Heavy-duty replacement fairlead for winches.</li> </ul>	
<b>Wired Remote Control</b>	With Can-Am HD winch	<b>715006504</b>
	<ul style="list-style-type: none"> <li>• This kit allows winch owners to add the hand-held remote to vehicles with a stock winch.</li> <li>• Works in conjunction with the mini-rocker switch.</li> <li>• Remote control and connection socket are included with Can-Am HD winch.</li> <li>• EC compliant.</li> </ul>	
<b>Wireless Remote Control</b>	With WARN winch (Traxter 2019 & prior)	<b>715002542</b>
	<ul style="list-style-type: none"> <li>• The system is quick and easy to install, thanks to a wiring harness with an integrated antenna and all necessary mounting hardware.</li> <li>• Allows you to operate your winch from anywhere within a 50' (15.2 m) radius, increasing your recovery options.</li> <li>• All components are weatherproof.</li> </ul>	
<b>Lower Front Receiver Hitch</b>	Traxter, Traxter MAX	<b>715002519</b>
	<ul style="list-style-type: none"> <li>• Heavy-duty 1,500 lb (680 kg) towing capacity 2" (5 cm) receiver hitch.</li> <li>• Expand and enhance functionality by pairing it with Higher Front Receiver Hitch and Removable Winch Mounting Kit (need to relocate winch from its standard mounting position).</li> </ul>	

<b>Higher Front Receiver Hitch</b>	Traxter, Traxter MAX (except Limited models)	<b>715003109</b>
------------------------------------	--	------------------



- Heavy-duty 1,500 lb (680 kg) towing capacity 2" (5 cm) receiver hitch.
- No need to relocate winch from its standard mounting position.

<b>Winch Electrical Harness</b> <i>(Not illustrated)</i>	Traxter, Traxter MAX (2019 & prior)	<b>715003093</b>
	Traxter, Traxter MAX (2020 & 2021)	<b>715007078</b>
	Traxter, Traxter MAX 2022	<b>715008152</b>

- Required to install a winch on a Traxter without a factory-installed winch.

<b>Front and Rear Hitch Drawbar</b>	Traxter, Traxter MAX	<b>715008350</b>
-------------------------------------	----------------------	------------------



- Standard on 2" (5 cm) receiver hitch.
- It offers 1,650 lb (750 kg) of towing capacity.
- Hitch ball not included.
- Forged steel.
- Not compliant with T-category.

<b>Rubber Receiver Plug</b>		<b>705204503</b>
-----------------------------	--	------------------



- Rubber cap for 2" (5 cm) Receiver Hitch.

# PERFORMANCE

<b>Performance Half Shaft</b>	Traxter and Traxter MAX (2019 & prior –except X mr, XT-P and XT CAB 2018-2019)	<b>705402353</b>
	Traxter, Traxter MAX XT Cab 2018-2019, Lone Star Edition 2019 & prior	<b>705402575</b>



- High-performance design ideal for off-road use, with superior wheel power and acceleration for racing, dunes and desert riding.
- Includes CVs, shaft and boots with the best suited geometry for your Can-Am vehicle.

<b>Brake Holding Mechanism</b>	Traxter, Traxter MAX	<b>715004733</b>
--------------------------------	----------------------	------------------



- Maintains constant pressure on the brake pedal to keep the vehicle from moving on sloped terrain, without having to put the transmission in P (park).
- Standard on T-category models.

<b>Heavy-Duty Spring Kit</b>	Traxter (Base, DPS (HD5, HD7, HD8 & HD9), XT (HD7, HD8 & HD9) & PRO (HD8)). (Except Traxter MAX, 6x6 and Traxter PRO).	<b>715005084</b>
------------------------------	--	------------------



- This set of heavy-duty springs will stiffen your suspension.
- Perfect for reducing vehicle overall sag when shocks are under heavy demand: heavy loading and hauling or for snow clearing.
- Complete kit of 4 springs.
- Not compatible with Traxter HD5, XT CAB, Mossy Oak Edition & X mr models and Traxter MAX.

<b>850 W Magneto Kit</b>	Traxter, Traxter MAX (2020 & up except HD5 & HD7)	<b>715007122</b>
--------------------------	---	------------------



- Increases the magneto output to 850 W.
- Includes rotor, stator and regulator.

<b>Emergency Kit</b>	Traxter, Traxter MAX	<b>715006102</b>
----------------------	----------------------	------------------



- Complete emergency kit provides all essential equipment and supplies to get out of most unfavorable situations powersport enthusiasts can find themselves in.
- Includes: jumper cables, air compressor, tire repair kit, first aid kit, ratchet tie-down, duct tape, tow strap 3,300 lb (1,500 kg), zip-ties, cloth rags.

## Air Intakes & Exhaust

<b>Snorkel Kit</b>	Traxter, Traxter MAX (except Traxter HD5, HD7 and Traxter PRO)	<b>715003727</b>
--------------------	--	------------------



- Raises point of engine and CVT air intakes so vehicle can be semi-submersed in water/mud without taking in water to the engine.
- Not compatible with Headache Racks, Gear Rail equipment, DragonFire Cargo Bed Roll Bar and Windshield Wiper & Washer Kit.
- Snorkel Extension Kit is available for roof level air intake and CVT exhaust.
- Adapter for Snorkel Kit (715004414) and Sealed Air Box (707801033) are required for installation on 2017 and prior models.
- Standard on Traxter X mr models.

<b>Snorkel Extensions</b>	Traxter, Traxter MAX	<b>715004415</b>
---------------------------	----------------------	------------------



- Extend the Snorkel Kit for roof engine and CVT air intake.
- Add aggressive look to your vehicle and help keep your intakes clear from mud, snow, dust, etc. in severe riding conditions.
- Not compatible with all rear panels and windows, Rear Cargo Light and roof-mounted Rear View Camera.
- Snorkel Kit (715003727) is required, except for X mr models.

<b>Adapter for Snorkel Kit</b> <i>(Not illustrated)</i>	Traxter and Traxter MAX 2017 & prior	<b>715004414</b>
--	--------------------------------------	------------------

- Required for the installation of Snorkel Kit (715003727) on Traxter 2017 and prior models.
- Includes rear firewall for Snorkel Kit and hardware.
- Standard on Traxter 2018 & up models.

<b>Sealed Air Box</b> <i>(Not illustrated)</i>	Traxter, Traxter MAX 2017 & prior	<b>707801033</b>
---	-----------------------------------	------------------

- Required when installing the Snorkel Kit (715003727) on Traxter and Traxter MAX 2017 and prior models.
- Standard on Traxter 2018 & up models.

<b>Snorkel Pre-FILTER</b>	Traxter, Traxter MAX (except Traxter PRO)	<b>715005597</b>
---------------------------	---	------------------



- Pre-filter specifically for snorkels.
- Adds extra protection to your engine in harsh riding conditions.
- Helps keep air filter cleaner.
- Filter blocks particles larger than 0.005" (0.13 mm).
- Necessary to maintain vehicle warranty when tracks are installed for winter use.
- For Traxter and Traxter HD10 models 2020 & up: Replace CVT intake of snorkel kit with CVT relocation kit 715008651 or 703501211.

<b>Air Intake Pre-Filter</b>	Traxter (except X mr models), Traxter MAX	<b>715003483</b>
------------------------------	---	------------------



- Adds extra protection to your engine in harsh riding conditions.
- Helps keep air filter cleaner.
- Filter blocks particles larger than 0.007" (0.19 mm).
- Easy, tool-less installation.
- Necessary to maintain vehicle warranty when tracks are installed.
- Required to install the Apache and Backcountry Track Systems.
- Not compatible with Snorkel Kit.



<b>Foam Air Filter by Twin AIR†</b>	Traxter, Traxter MAX	<b>715003630</b>
-------------------------------------	----------------------	------------------



- The best choice for the harshest conditions.
- Multiple staged oiled filtering foam for superior dust retaining capacity with high air flow.
- Washable and reusable.

<b>NEW CVT Air Intake Relocation Kit</b>	Traxter, Traxter MAX (without Snorkel Kit)	<b>703501210</b>
	Traxter, Traxter MAX (X mr models or models with Snorkel Kit)	<b>703501211**</b>



- The CVT air intake relocation kit is MANDATORY for track-equipped 2020 to 2022 and some 2023\* Traxter and Traxter HD10 models used in snow conditions and highly recommended for other models.
- This kit is sold separately.

*\*Comes from the factory on some MY23; inspect the vehicle to confirm.  
Mandatory on all MY20 and up Traxter and Traxter HD10 models equipped with a snorkel.  
\*\*When installed, it temporarily relocates CVT air intake to the standard factory location.*

# APACHE TRACK SYSTEMS

## Winter Tracks Limited Warranty\*

<b>Apache BackCountry LT Track Kit</b>	Traxter, Traxter MAX (except 6x6)	<b>715005891</b>
--	-----------------------------------	------------------



- Tracks designed to deliver the best snow performance on the market with unmatched flotation level and traction on snow surface.
- Large contact patch, 37% bigger than the Apache 360 LT.
- Impressive added ground clearance of 7" (18 cm) helps keep the vehicle over the snow.
- Lightweight snowmobile-inspired rail design.
- Aggressive track design with 2" (5 cm) lug height for maximum traction on snow.
- Apache Backcountry LT Mounting Kit, Track DPS Module and Engine Pre-Filter are required and sold separately.
- The CVT air intake relocation kit is MANDATORY for track-equipped 2020 to 2022 and some 2023\* Traxter and Traxter HD10 models and highly recommended for other models. This kit is sold separately.
- For winter use only.
- Track installation will affect vehicle width and length.
- Fine-tune your track system using extra Idler Wheels, Sliders with Vespel Inserts and Rail Ice Scratcher.

*\*Comes from the factory on some MY23, inspect the vehicle to confirm.  
Mandatory on all MY20 & up Traxter and Traxter HD10 models equipped with a snorkel.*

*Installation of some accessories shown may impact vehicle compliance with some regulations. Consult your local dealer for information.*

<b>Apache Backcountry LT Mount Kit</b> <i>(Not illustrated)</i>	See table for fit, compatibility and requirements.	<b>715005888</b> <b>715005493</b> <b>715006196</b>
--	--	--

- Required for installation of the Apache Backcountry Track LT System.
- DPS Module and Engine Pre-Filter are required and sold separately.
- The CVT air intake relocation kit is MANDATORY for track-equipped 2020 to 2022 and some 2023\* Traxter and Traxter HD10 models and highly recommended for other models. This kit is sold separately.

*\*Comes from the factory on some MY23, inspect the vehicle to confirm.  
Mandatory on all MY20 & up Traxter and Traxter HD10 models equipped with a snorkel.*

*Installation of some accessories shown may impact vehicle compliance with some regulations. Consult your local dealer for information.*

<b>Rail Ice Scratchers</b>	Apache Backcountry and Backcountry LT Track Systems	<b>860201728</b>
----------------------------	---	------------------



- Provide additional lubrication in hard and icy conditions and extend slider life.
- Rail mounted, small, light.
- Design expands on coil concept to allow reversing without damage.
- Easily stored when not in use.

<b>Extra Wheel Kit</b>	Apache Backcountry LT Wheel Kit	<b>715006293</b>
------------------------	---------------------------------	------------------



- Additional wheel kit for Backcountry LT rear tracks.
- Reduces drag and rolling resistance in hard snow conditions or when transporting heavier loads.
- Extends slider life in hard snow conditions.
- Includes two wheels, cross shaft and mounting hardware per kit to service one track corner.
- Up to two kits per rear track can be installed.

\*The limited warranty is subject to the exclusions, limitations of liabilities and all other terms and conditions of BRP's standard limited warranty.

## Apache Backcountry LT Tracks Fitting Guide

Model Year / Model	Length	Track	Track Mount	Track DPS Module	CVT Pre-Filter	Engine Pre-Filter	
2019 & Prior	Traxter Base, DPS, XT, XT Cab 2017 & Hunting Edition, XT-P	62"	715005891	715005888	715007338	703501210 (w/o Snorkel Kit) 703501211 (w/ Snorkel Kit)	
2019 & Prior	Traxter XT Cab 2018-2019, Lone Star Edition & X mr	67"		715006196			
2020 & Up	Traxter Base, DPS (HD5, HD7, HD8, HD9), DPS (HD10 T-cat 2020), XT (HD8, HD9), PRO T-cat 2020 (HD8, HD10), XU (HD7 T-cat)	62"		715005888			
2020 & Up	Traxter DPS (HD10), XT (HD10), XT-P, PRO DPS, PRO XU, XU (HD10 T-cat) 2021 & up, XU (HD9 T-cat)	64"		715005493			715005597 (w/ Snorkel Kit) 715003483 (w/o Snorkel Kit)
2020 to 2022	Traxter XT Cab, XT Cab Limited, Hunting Edition, Lone Star Edition, X mr, PRO Limited, PRO Lone Star	67"		715006196			
2023 & Up	Traxter XT Cab, XT Cab Limited, Hunting Edition, Lone Star Edition, X mr, PRO Limited, PRO Lone Star	67"		715005493			
2024	Traxter HD7	62"		715005888			715006266

## Year-Round Tracks

## Limited Warranty\*

### Apache 360 LT Track System

Traxter, Traxter MAX (except 6x6)

715005103



- Multifunctional tracks designed to support heavy loads and to fit on most Can-Am off-road vehicles.
- Extra contact patch adjustment for better performance over rough terrain.
- Contact patch is 7 to 9% bigger than the Apache 360's.
- Average ground clearance of 16" (41 cm). 1" (2.5 cm) lugs in the front and 1.25" (3.2 cm) in the back.
- EC compliant.
- Apache 360 LT Mounting Kit, Track DPS Module and Engine Pre-Filter Kit are required and sold separately.

- The CVT air intake relocation kit is MANDATORY for track-equipped 2020 to 2022 and some 2023 Traxter and Traxter HD10 models used in snow conditions and highly recommended for other models. This kit is sold separately.

*\*Comes from the factory on some MY23, inspect the vehicle to confirm.*

*Mandatory on all MY20 & up Traxter and Traxter HD10 models equipped with a snorkel.*

*Installation of some accessories shown may impact vehicle compliance with some regulations. Consult your local dealer for information.*

### Apache 360 LT Mounting Kit

(Not illustrated)

See table for fit, compatibility and requirements.

715004832

715004831

715005492

- Required for installation of the Apache 360 LT Track System.
- DPS module and Engine Pre-Filter not included.
- The CVT air intake relocation kit is MANDATORY for track-equipped 2020 to 2022 and some 2023 Traxter and Traxter HD10 models used in snow conditions and highly recommended for other models.

- This kit is sold separately

*\*Comes from the factory on some MY23, inspect the vehicle to confirm.*

*Mandatory on all MY20 & up Traxter and Traxter HD10 models equipped with a snorkel.*

*Installation of some accessories shown may impact vehicle compliance with some regulations. Consult your local dealer for information.*

### Track DPS Module

(Not illustrated)

715007338

- An innovative DPS module that ensures speedometer accuracy and optimized steering assist, which make for perfect track control and riding ease.
- Required to install the Apache and Backcountry Track Systems.

*Installation of some accessories shown may impact vehicle compliance with some regulations. Consult your local dealer for information.*

\*The limited warranty is subject to the exclusions, limitations of liabilities and all other terms and conditions of BRP's standard limited warranty.

## Apache 360 LT Tracks Fitting Guide

Model Year / Model	Length	Track	Track Mount	Track DPS Module	CVT Pre-Filter	Engine Pre-Filter	
2019 & Prior	Traxter Base, DPS, XT, XT Cab 2017 & Hunting Edition, XT-P	62"	715005103	715004831	715007338	703501210 (w/o Snorkel Kit) 703501211 (w/ Snorkel Kit)	
2019 & Prior	Traxter XT Cab 2018-2019, Lone Star Edition & X mr	64"		715004832			
2020 & Up	Traxter Base, DPS (HD5, HD7, HD8, HD9), DPS (HD10 T-cat 2020), XT (HD8, HD9), PRO T-cat 2020 (HD8, HD10), XU (HD7 T-cat)	62"		715004831			
2020 & Up	Traxter DPS (HD10), XT (HD10), XT-P, PRO DPS, PRO XU, XU (HD10 T-cat) 2021 & up, XU (HD9 T-cat)	64"		715005492			715005597 (w/ Snorkel Kit) 715003483 (w/o Snorkel Kit)
2020 to 2022	Traxter XT Cab, XT Cab Limited, Hunting Edition, Lone Star Edition, X mr, PRO Limited, PRO Lone Star	67"		715004832			
2023 & Up	Traxter XT Cab, XT Cab Limited, Hunting Edition, Lone Star Edition, X mr, PRO Limited, PRO Lone Star	67"		715005492			
2024	Traxter HD7	62"		715004831			715006266

# PROMOUNT PLOWS

## Can-Am ProMount Flex2 Plow Kit

### Can-Am ProMount Flex2 72" (183 cm) Blade Plow Kit

Traxter, Traxter MAX

715008170



- These kits include:
  - Can-Am ProMount Flex2 Blade
  - Push Frame with Quick-Attach System
  - Mounting Plate

## Can-Am ProMount Flex2 Blades

### Can-Am ProMount Flex2 66" (168 cm) Blade

Fits ProMount Push Frame

715006265



- Plow blade made of UHMWPE, flexible and impact absorbing material prevents damaging your plow when accidental impact occurs.
- Replaceable wear blade.
- Large pin designed for easy blade rotation to eliminate snow buildup at pivot point.
- Blade design provides best snow roll-off at any angle.
- Clears 60" (152 cm) when plow is fully angled.
- Blade height of 17" (43 cm).
- Compatible with Can-Am ProMount Blade accessories to further enhance plow versatility.

### Can-Am ProMount Flex2 72" (183 cm) Blade

Fits ProMount Push Frame

715004485



- Plow blade made of UHMWPE, flexible and impact absorbing material prevents damaging your plow when accidental impact occurs.
- Replaceable wear blade.
- Large pin designed for easy blade rotation to eliminate snow buildup at pivot point.
- Blade design provides best snow roll-off at any angle.
- Clears 66" (168 cm) when plow is fully angled.
- Blade height of 17" (43 cm).
- Compatible with Can-Am ProMount Blade accessories to further enhance plow versatility.

## Can-Am ProMount Steel Plow Kit

### Can-Am ProMount Steel 72" (183 cm) Blade Plow Kit

Traxter, Traxter MAX

■ 715008172 · Black  
■ 715008171 · Yellow



- These kits include:
  - Can-Am ProMount Steel Blade
  - Push Frame with Quick-Attach System
  - Mounting Plate

## Can-Am ProMount Steel Blades

### Can-Am ProMount Steel 66" (168 cm) Blade

Fits ProMount Push Frame

■ 715006337 · Black  
■ 715006338 · Yellow



- Plow blade made from 12-gauge steel.
- Replaceable wear blade.
- Large pin designed for easy blade rotation to eliminate snow buildup at pivot point.
- Blade design provides best snow roll-off at any angle.
- Clears 60" (152 cm) when plow is fully angled.
- Blade height of 17" (43 cm).
- Compatible with Can-Am ProMount Blade accessories to further enhance plow versatility.
- Not compatible with S3 High Clearance Front A-Arm.

### Can-Am ProMount Steel 72" (183 cm) Blade

Fits ProMount Push Frame

■ 715004474 · Black  
■ 715006021 · Yellow



- Plow blade made from 12-gauge steel.
- Replaceable wear blade.
- Large pin designed for easy blade rotation to eliminate snow buildup at pivot point.
- Blade design provides best snow roll-off at any angle.
- Clears 66" (168 cm) when plow is fully angled.
- Blade height of 17" (43 cm).
- Compatible with Can-Am ProMount Blade accessories to further enhance plow versatility.
- Not compatible with S3 High Clearance Front A-Arm.



## ProMount Plow Kits - Reference Charts

	66" Black Steel	66" Yellow Steel	66" Flex2	72" Black Steel	72" Yellow Steel	72" Flex2
Plow Kit	-	-	-	715008172	715008171	715008170
Blade	715006337	715006338	715006265	715004474	715006021	715004485
Push Frame	715008116	715008116	715008116	715008116	715008116	715008116
Mounting Plate	715007745	715007745	715007745	715007745	715007745	715007745

## Can-Am ProMount Angle Plows

### Can-Am ProMount 66" (168 cm) Steel Oneway State Blade

Fits ProMount Push Frame

715007263



- Make the job easier with the right tools, clear long alleys and make the task easier by sending the snow further out of the way.
- Wing end of plow measures 26" (67 cm) high and tapers down to 16" (41 cm).

- One-way "winged" state plow designed to throw snow higher.
- Rubber Flap (715007299) designed to keep snow away from the driver is offered as accessory (sold separately).
- Can-Am branded.

### Can-Am ProMount 72" (183 cm) Steel Oneway State Blade

Fits ProMount Push Frame

715007264



- Make the job easier with the right tools, clear long alleys and make the task easier by sending the snow further out of the way.
- Wing end of plow measures 26" (67 cm) high and tapers down to 16" (41 cm).

- One-way "winged" state plow designed to throw snow higher.
- Rubber flap (715007299) designed to keep snow away from the driver is offered as accessory (sold separately).
- Can-Am branded.

## Can-Am ProMount Plow Accessories

### Can-Am ProMount Edge Markers

Traxter, Traxter MAX

715004206



- Help locate the edges of your plow.
- Height: 24" (60 cm).
- Sold in pairs.
- Compatible with Can-Am ProMount Steel and Flex2 blades with or without Blade Extensions (except for the Can-Am ProMount Steel 54" (137 cm) Blades).

### Can-Am ProMount 66" (168 cm) Plastic Wear Blade

Traxter, Traxter MAX

715004482

### Can-Am ProMount 72" (183 cm) Plastic Wear Blade

Traxter, Traxter MAX

715004483



- To help prevent scratches on smooth driveways and markable surfaces.

### Can-Am ProMount Drift Cutters

Traxter, Traxter MAX

715006258



- Help keep snow in the plow.
- Dimensions: 17" x 13" (43.2 cm x 33 cm).
- Sold in pairs.
- Compatible with Can-Am ProMount Steel and Flex2 blades with or without Blade Extensions (except for the Can-Am ProMount Steel 54" (137 cm) Blades).

## Can-Am ProMount Blade Extensions

Traxter, Traxter MAX

■ **715004205** · Black  
■ **715005319** · Yellow



- Add 3" (8 cm) each side.
- Compatible with Can-Am ProMount Blades (except for Can-Am ProMount Steel 54" [137 cm] Blade).
- Longer Wear Blade can be installed to further extend the extra length already provided by the extensions.
- Compatible with Can-Am ProMount Steel and Flex2 Blades (except for the Can-Am ProMount Steel 54" [137 cm] Blades).

## Back Drag Blade

(Not illustrated)

ProMount Plows (60" and more)

**715007794**

- ¼ thick steel swivel scraper.
- Lifts up when the vehicle is moving forward so as not to affect the scraping.
- Increased capacity to pull snow.
- More aggressive scraping in reverse mode.
- Lifts the scraper off the ground so that it scrapes evenly.
- Adjustable in length for compatibility with 60", 66" and 72" blades.
- Compatible with ProMount blades (Flex and Steel).

## Can-Am ProMount Push Frame with Quick-Attach System

Traxter, Traxter MAX

**715008116**



- Heavy-duty steel tubes designed to withstand the roughest use.
- Mid-mount carriage provides ultimate push strength and traction.
- Designed for maximum plow lift height.
- Features a self-aligning quick-attach system, an easy foot release pedal and an ergonomic handle for plow angle adjustment.
- Plow Limit Switch recommended to extend winch cable lifespan.
- Can-Am ProMount Mounting Plate required for installation.
- Blade swivels left or right, 5 positions.
- Large pin designed for easy blade rotation to eliminate dirt and snow buildup at pivot point.

## Can-Am ProMount Push Frame Extension

Traxter, Traxter MAX

**715006257**

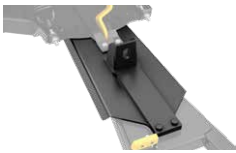

- 12" (30 cm) push frame extension required when plow is installed with Apache Track Systems.

## Can-Am ProMount Mounting Plate

Traxter, Traxter MAX (2021 & prior)

**715007743**



- Required to install the Can-Am ProMount Push Frame with Quick-Attach System.
- Mounting plate precision-designed to stay on year round without compromising ground clearance.
- Comes with the Plow Roller Fairlead.
- Not compatible with S3 Front High Clearance A-Arm (715003784).

## Can-Am ProMount Mounting Plate

Traxter, Traxter MAX (2022 & up)

**715007745**



- Required to install the Can-Am ProMount Push Frame with Quick-Attach System.
- Mounting plate precision-designed to stay on year round without compromising ground clearance.
- Comes with the Plow Roller Fairlead.
- Not compatible with S3 Front High Clearance A-Arm (715003784).

## Can-Am ProMount Plow Angling System

Traxter, Traxter MAX

**715009241**



- Converts your plow system into an easy-to-control unit from the driver's seat.
- Allows you to have full up/down and left/right plow control at your fingertips with the supplied joystick.
- Using one hand to control all plow motions allows you to easily concentrate and manage your plowing tasks.
- Compatible with the SxS ProMount Push Frame and Blade.
- Not compatible with Apache Backcountry LT Track System.
- Push Frame Extension (715006257) is required for installation with the Front Rancher Bumper.
- Winch and plow sold separately.

**ProMount Plow Limit Switch***(Not illustrated)*

Traxter, Traxter MAX

**715006259**

- For controlling the cable tension when over-raising your plow system.
- Prevents winch, plow push frame and vehicle damage.
- Sensor relocated for optimal lift height.

**Plow Roller Fairlead**

Traxter, Traxter MAX

**715001223**

- Cylindrical roller fairlead
- Larger diameter lower roller reduces wear on wire rope for plow application.
- Can be used with all ProMount plows.

**Super-Duty Plow System****Super-Duty 72" (183 cm) Blade Plow Kits**

Traxter, Traxter MAX

**715003416**

- A comprehensive plow system with manual lift and angling.
- Ultra-durable 72" (183 cm) blade made of 12-gauge steel with integrated reinforcement and heavy-duty push tubes to tackle the most demanding jobs.
- Requires a winch for raising and lowering.
- Convenient disconnect system for quick and easy installation or removal.
- Front mount provides minimum 11" (28 cm) lift distance.

This kit includes:

- 72" (183 cm) Super-Duty Plow.
- Super-Duty Plow Push Frame.
- Super-Duty Plow Mounting Kit.

**Super-Duty Plow Hydraulic Angling Kit**

Traxter, Traxter MAX (2019 &amp; prior)

**715002840**

Traxter, Traxter MAX (2020 &amp; up)

**715006038**

- Allows you to have full up/down and left/right plow control at your fingertips.
- Pre-assembled, it comes with everything you need to turn your Super-Duty Plow into a quick, easy-to-control unit from the driver's seat.
- Using one hand to control all plow motions with the supplied joystick will allow you to easily concentrate and manage your plowing tasks.
- With this commercial grade kit, you will send snow exactly where you want reliably all winter long.
- Winch and plow sold separately.

**Super-Duty Plow Push Frame Extension***(Not illustrated)*

Super-Duty Plow

**715001221**

- Extension to use the Super-Duty Plow with the Apache 360 LT Track System.
- Comes with Plow Magnetic Switch and Plow Pulley.
- Requires Front Bumper or Front Accessory Bar for installation.

**Plow Blade Extensions**

Super-Duty Plow

**715001217**

- Side extensions for widening your plow blade by 6" (15 cm) on each side.
- Include rubber flaps for extension parts.
- Sold in pairs.

**Plow Edge Markers***(Not illustrated)*

Super-Duty Plow

**715001216**

- For a more accurate view of the width of your plow.
- Allows you to work closely around objects.

**Plow Drift Cutter***(Not illustrated)*

Super-Duty Plow

**715001218**

- Keeps snow securely in the plow.
- Allows you to cut a cleaner pass.
- Sold individually.

<b>Plow Rubber Flap</b> <i>(Not illustrated)</i>	Super-Duty Plow	<b>715001219</b>
<ul style="list-style-type: none"> <li>Keeps snow away from the driver and helps snow to roll in front of the plow.</li> </ul>		
<b>Plow Pulley</b> <i>(Not illustrated)</i>	Super-Duty Plow	<b>715002042</b>
<ul style="list-style-type: none"> <li>For use with the Super-Duty Plow.</li> <li>Helps winching efficiency.</li> <li>Requires Front XT Bumper.</li> </ul>		
<b>Plow Magnetic Switch</b> <i>(Not illustrated)</i>	Super-Duty Plow	<b>715001995</b>
<ul style="list-style-type: none"> <li>Magnetic switch that stops the winch to prevent cable, winch and frame damage.</li> <li>For use with Super-Duty Plow.</li> </ul>		

# COVERS & ADD-ONS

<b>Trailer Cover</b>	Traxter, Traxter 6x6, Traxter PRO	<b>715004453</b>
	Traxter MAX	<b>715004454</b>
	<ul style="list-style-type: none"> <li>Heavy-duty canvas made of UV-resistant solution-dyed polyester.</li> <li>Inner soft liner protects windshield and colored panels from abrasion.</li> <li>All high-abrasion areas are reinforced with a double canvas layer.</li> </ul>	
	<ul style="list-style-type: none"> <li>Weather-resistant trailering cover protects your vehicle during storage and transportation.</li> <li>Opening for fuel cap.</li> <li>Quick and easy installation.</li> <li>Designed to perfectly fit your vehicle with or without Can-Am accessories.</li> <li>Does not fit with Adventure Roof Rack (715003870).</li> </ul>	

<b>Bolt-On† Retractable Ratcheting Tie-Downs</b>	<b>295101072</b>
	<ul style="list-style-type: none"> <li>Perfect for transporting your powersport vehicle or securing loads.</li> <li>Mounts easily: Bolts on any flat surface (e.g., truck bed or frame).</li> <li>1" x 6' (2.5 cm x 1.8 m) tie-down strap with heavy-duty stitching that delivers a 500 lb (226 kg) working load strength and 1,500 lb (680 kg) break strength.</li> </ul>
	<ul style="list-style-type: none"> <li>Convenient retractable push button automatically slackens, spools and stores away strap, while the ratchet mechanism tightens the strap snugly to secure your vehicle or load into place.</li> <li>Rubber ratcheting handle provides firm grip, and the hook is vinyl coated to protect whatever surface it hooks into.</li> <li>Sold in pairs.</li> </ul>

<b>Ratchet Tie-Downs</b>	<b>715008309</b> · Black/Gray
	<ul style="list-style-type: none"> <li>400 lb (181 kg) safe working load.</li> <li>1" x 10' (2.5 cm x 3 m) strap with Sea-Doo, Ski-Doo and Can-Am logos.</li> <li>Deluxe ratchet with rubber handle.</li> <li>Coated S hooks.</li> <li>Pack of 2.</li> </ul>

<b>Heavy-Duty Ratchet Tie-Down</b>	<b>715008308</b>
	<ul style="list-style-type: none"> <li>1,000 lb (454 kg) safe working load.</li> <li>1.5" x 6' (38 mm x 1.8 m) strap with BRP brands.</li> <li>Deluxe ratchet with rubber handle.</li> <li>Black-coated clip hooks.</li> <li>12" (300 mm) webbing included.</li> <li>Pack of two.</li> </ul>





---

# CAN-AM MAVERICK

---



---

# CAN-AM MAVERICK

---

## ACCESSORIES

Roofs	55
Soft Cab Enclosure	56
Windshields & Wind Protection	56
Mirrors	58
Doors	59
Seat Accessories	60
HMWPE Skid Plates	61
Bumpers & Guards	62
LinQ: Easy On, Easy Off Cargo	65
Racks & Storage	69
Lights	71
Audio & Communication Systems	75
Electrical & Electronic Accessories	76
Winches & Hitches	78
Performance	80
Apache Track Systems	83
ProMount Plows	85
Cover & Trailering	88







# MAVERICK ACCESSORIES

# BUNDLE UP TO GET AFTER IT. YOUR MAVERICK BUNDLES.

## STEP 1: CHOOSE YOUR ESSENTIAL BUNDLE

		Maverick	Maverick MAX
<b>STARTER</b>	Sport Roof	715005521	715003750
	Tinted Half Windshield	715004291	715004291
	Rear Wind Screen	715006701	715006701
	Rally Side Mirrors	715005262	715005262
	Front Lower Door Panels	715002903	715002903
	Rear Lower Door Panels	N/A	715003751
<b>ADVANCED</b>	Electronic Device Holder	715002874	715002874
	Shoulder Storage Bag	715004277	715004277
	LinQ 8 Gal (30L) Cooler Box	715004778	715004778
<b>PEAK</b>	Rear View Mirror and Camera Monitor	715009410	715009410
	Front Pre-Runner Bumper	715002878	715002878
	Fender Flares	715002973	715002973
	LinQ Tool Kit	715006829	715006829
	Adventure Roof Rack	715006225	715003868

## STEP 2: PICK YOUR ADD-ON BUNDLE

		Maverick	Maverick MAX
<b>AUDIO</b>	Can-Am Audio Roof	715007130	715006709
	Can-Am Audio Roof Flip Kit	715007131	715007131
	Can-Am Subwoofer	715004956	715004956
	Can-Am Amplifier Kit	715007227	715007227
<b>LIGHT</b>	Light Support Bar	715003529	715003529
	Light Power Cable	715007117	715007117
	40" Baja Designs OnX6 Arc LED Light Bar	710006818	710006818
	Chase Lights	715009887	715009887
<b>RIDER</b>	4-Point Harness (Driver)	715005021	715005021
	4-Point Harness (Passenger)	715005022	715005022
	Lonestar Racing Fire Extinguisher Support	715007320	715007320
<b>CABIN STORAGE</b>	Overhead Storage Bag	715004275	715004275
	Upper Door Storage Bags	715004276	715004276
	Lower Door Panel Storage Bags	715004355	715004355
	Front Storage Bag	N/A	715004888



# ROOFS

## Sport Roof

Maverick  
Maverick MAX

715005521  
715003750



- Impact-resistant injected polypropylene.
- Excellent protection from the elements.
- Provides excellent downhill visibility.
- Windshield compatible.
- Standard on X rs model.
- Easy, tool-less installation and removal with quick-release ¼ turn fasteners and Velcro straps.

## ProVent Roof Module Kit

Maverick, Maverick MAX

715005279



- Provides fresh air in the cab area.
- Optimal performance with full cab enclosure.
- 4 vents provide infinite adjustment of air flow for driver and passenger.
- Filter and pre-filter to limit dust intrusion.
- Easy cleaning of filter and pre-filter.
- Patent pending water management system to keep water out of cabin while maintaining air flow.
- Outer plug closes air intake completely for winter or heavy weather.
- Sport Roof requires ProVent Module Adapter Kit.
- Not compatible with roof mounted LED bars, roof racks (715006225/715003868) or roof liners, Lonestar Roof, and Bimini tops.

## ProVent Roof Module Adapter Kit for Sport Roof

(Not illustrated)

Maverick  
Maverick MAX

715006199  
715006371

- Adapter for fitting ProVent Roof Module Kit onto Maverick X3.
- Includes roof adapter and hardware.
- Requires ProVent Roof Module Kit (715005279).

## Aluminum Roof

Maverick

■ 715004224 · Black  
■ 715002900 · Silver



- Formed aluminum roof 0.09" (2.3 mm) thick.
- Durable and lightweight.
- Sporty look.
- Windshield compatible.
- Easy and tool-less installation.

## Bimini<sup>†</sup> Roof with Sun Visor

Maverick  
Maverick MAX

715002901  
715003749



- Heavy-duty canvas made of UV-resistant solution-dyed polyester.
- Innovative soft top comes with a hard visor that allows for storage of rolled-up soft top.
- Easy, tool-less installation and removal with quick-release/turn fasteners and Velcro straps.

## Tinted Sun Visor

Maverick, Maverick MAX

715007098



- Tinted polycarbonate construction.
- Extra protection for driver and passenger from the sun.
- Not compatible with Aluminum Roof and Full Windshields.

## Lonestar Racing Aluminum Roof

Maverick produced after January 1, 2017  
Maverick MAX

■ 715005507 · Black  
■ 715005515 · Black



- 0.083" (2.1 mm) thick aluminum roof.
- Durable and lightweight.
- Enhances the vehicle's racing appearance thanks to an authentic sporty look combined with unique graphics.
- Offers you protection from the elements with a personalized touch.
- Lower profile than other roofs.
- Compatible with Lonestar Racing Light Bar Racks.
- Not compatible with LinQ Pivoting Rack, Light Support Bar and Full Windshields.
- "Lonestar Racing for Can-Am" branded.
- Includes middle intrusion bars for installation

# SOFT CAB ENCLOSURE

<b>Soft Cab Enclosure</b>	Maverick (except X mr models)	<b>715003754</b>
	Maverick MAX (except X mr models)	<b>715003755</b>



- Protection for rider and passenger from the elements.
- For added cabin comfort, complete your cab enclosure with Cab Seal Kit.

- Includes:
  - Bimini roof with sun visor
  - Full windshield — hardcoated
  - Upper soft door panels
  - Front lower door panels
  - Soft rear window

<b>Cab Seal Kit</b> <i>(Not illustrated)</i>	Maverick	<b>715004433</b>
	Maverick MAX	<b>715004434</b>

- Prevents dirt, dust and wind infiltration in the cab area.
- Improves cabin comfort for driver and passenger.
- Recommended with Soft Cab Enclosures.

# WINDSHIELDS & WIND PROTECTION

## Windshields

<b>PowerFlip Windshield</b>	Maverick, Maverick MAX	<b>715007097</b>
-----------------------------	------------------------	------------------



- The PowerFlip Windshield is equipped with electric cylinders that allow the rider to adjust the windshield opening at the touch of a button.
- Windshield is made of hardcoated polycarbonate with a rubber seal contour and a tinted top section.
- Allows you to quickly adapt to changing conditions by adjusting the windshield as you go.

- Can be fully opened for optimal visibility and ventilation, fully closed for maximum protection from the elements, and in between, you have an infinite number of opening possibilities depending on protection, visibility and air flow preferences.
- Compatible with Can-Am roofs.

<b>Windshield Wiper for PowerFlip Windshield</b>	Maverick, Maverick MAX	<b>715006310</b>
--	------------------------	------------------



- An ideal way to keep your windshield clear in rain or while riding through mud and water.
- Wiper from the top allows windshield pivoting. Includes single-speed wiper and washer-fluid dispenser.

- Wiper mechanism and washer-fluid dispenser perfectly concealed within the vehicle.
- Must be installed with the PowerFlip Windshield (sold separately).

<b>Provent Windshield</b>	Maverick, Maverick MAX	<b>715005277</b>
---------------------------	------------------------	------------------



- High-impact-resistant Quantum hardcoated polycarbonate full windshield.
- Controllable vents to manage air flow.
- Optimal performance with full cab enclosure.
- Channels air into the cabin, defogs windshield, fully closes to eliminate air flow.
- One upper vent and one lower vent with pre-filters.
- Formed polycarbonate construction for enhanced rigidity.

- Protects driver and passenger from the elements.
- Quick and easy tool-less installation or removal.
- Not compatible with wiper kits and Wet Sounds Stealth 6 Ultra HD Can-Am Edition Sound Bar.
- Upper vent channels air into the cabin.
- Lower vents defog windshield.
- Provides excellent optical clarity and better abrasion resistance.

<b>Glass Windshield</b>	Maverick, Maverick MAX	<b>715008859</b>
-------------------------	------------------------	------------------



- Curved and laminated glass full windshield.
- Seals firmly against the cage and protects rider and passenger from the elements.
- Provides the best optical clarity and abrasion resistance.
- Must be used with Windshield Wiper & Washer Kit to maintain clear visibility during severe riding conditions, such as mud riding.
- Recommended to use with rear wind protection to maximize comfort for passenger.

**Glass Windshield with Wiper & Washer Kit**

Maverick, Maverick MAX

**715008858**

- Complete kit that includes a curved and laminated glass windshield with a single-speed wiper and washer fluid dispenser.
- Seals firmly against the cage and protects rider and passenger from the elements.
- An ideal way to keep your windshield clear in rain, or while riding through mud and water.
- Recommended to use with rear wind protection to maximize comfort for passenger.

**Full Windshield**

Maverick, Maverick MAX

**715002907**

- High-impact-resistant durable polycarbonate full windshield.
- Formed polycarbonate construction for enhanced rigidity.
- Formulated to be non-yellowing, non-crazing, non-cracking with excellent UV resistance and optical clarity.
- Protects driver and passenger from the elements.
- Quick and easy tool-less installation or removal.
- Recommended to use with rear wind protection to maximize comfort for passenger.

**Full Windshield – Hardcoated**

Maverick, Maverick MAX

**715004417**

- High-impact-resistant Quantum hardcoated polycarbonate full windshield.
- Formed polycarbonate construction for enhanced rigidity.
- Provides excellent optical clarity and better abrasion resistance.
- Protects driver and passenger from the elements.
- Quick and easy tool-less installation or removal.
- Recommended to use with rear wind protection to maximize comfort for passenger.
- Can be used with the Windshield Wiper and Washer Kit (715004762).

**Half Windshield**

Maverick, Maverick MAX

 **715002909** · Clear  
 **715004291** · Tinted

- High-impact-resistant durable polycarbonate half windshield.
- Formed polycarbonate construction for enhanced rigidity.
- Formulated to be non-yellowing, non-crazing, non-cracking with excellent UV resistance and optical clarity.
- Protects driver and passenger from the elements.
- Features reverse angle lip to deflect air flow.
- Quick and easy tool-less installation or removal.

**Windshield Wiper & Washer Kit**

Maverick, Maverick MAX Fit with Full Windshield Hardcoated (715004417)

**715004762**

Maverick, Maverick MAX Fit with Glass Windshield (715008859)

**715003282**

- An ideal way to keep your windshield clear in rain, or while riding through mud and water.
- Includes single-speed wiper and washer fluid dispenser.
- Wiper mechanism and washer fluid dispenser perfectly concealed within the vehicle.

**NEW Manual Wiper Kit**

Maverick, Maverick MAX

**715009424**

- Single manual wiper that can be used to clear windshield of debris.
- Easy to install system that requires no electrical hookup.
- Large ergonomic handle provides a good grip over the entire sweeping surface.
- Compatible with glass and hardcoated windshields that use top mounted wipers.

## Wind Protection

### Rear Wind Screen

Maverick, Maverick MAX  
(except X mr models)

715006701



- Full rear mesh screen reduces windshield backdraft for added cabin comfort.
- Installs quickly and easily on roll cage.
- Large white Can-Am logo on black mesh.

### Rear Polycarbonate Window

Maverick, Maverick MAX  
(except X mr models)

715006387



- High-impact-resistant polycarbonate window.
- Blocks windshield backdraft or dust and rain from entering for added cabin comfort.
- Quick and easy tool-less installation.
- Ready for MTX Audio System Rear Speakers.

### Soft Rear Window

Maverick, Maverick MAX  
(except X mr models)

715006702



- Clear, flexible window made from transparent vinyl.
- Resists cold-cracking to -4°F (-20°C).
- Ideal for preventing backdraft of dust or rain in harsh environments.
- Quick tool-less installation.

## MIRRORS

### NEW Aluminum Side Mirrors

Maverick, Maverick MAX

715007363

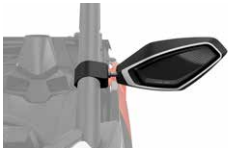

- Sleek design.
- High-quality black molded aluminum for extreme durability.
- The convex surface provides a wider field of view and better visibility around the unit.
- Can be installed at any height on the cage A-pillar for optimized rider vision.
- Possibility to install the Integrated LED Side Mirror Lights (715007185).
- Adjustable ball-joint mirrors.
- Possibility to fold down the mirrors (fold-away mechanism).
- Not compatible with Glass Windshield.
- Sold in pairs.

### NEW Side Mirrors

Maverick, Maverick MAX

715007188



- Sleek design.
- High-impact resistant plastic mirrors.
- The convex surface provides a wider field of view and better visibility around the unit.
- Can be installed at any height on the cage A-pillar for optimized rider vision.
- Adjustable ball-joint mirrors.
- Possibility to fold down the mirrors (fold-away mechanism).
- Not compatible with Glass Windshield.
- Sold in pairs.

### Side Mirrors

Maverick, Maverick MAX

715004236

• For stock quarter doors

715005315

• For aluminum doors



- Rugged cast aluminum mount with black nylon cover.
- Multi-position adjustable ball-joint mounted mirrors.
- Convex optics for a wide viewing angle.
- Spring-loaded pivots let mirrors fold back completely.
- Door mounted.
- Compatible with Upper Soft Door Panels.
- Sold in pairs.



### Racing Side Mirrors

Maverick, Maverick MAX

715002898



- Race-inspired design features rugged black nylon 90% construction with coated cast-aluminum mount.
- Dual adjustment provides optimal field of view (FOV).
- Multi-position adjustable ball-joint mounted mirrors.
- Flat optics deliver improved distance perception.
- Spring-loaded pivots let mirrors fold back completely.
- Not compatible with Lonestar Racing Light Racks, Upper Soft Door Panels or Flip Audio Roof Kit (715007131).
- Sold in pairs.

### Rally Side Mirrors

Maverick, Maverick MAX

715005262



- Sleek design with unique racing style.
- High-quality black molded aluminum for extreme durability.
- 4" (10 cm) convex surface provides a wider field of view and better visibility around the unit.
- Can be installed at any height on the cage A-pillar for optimized rider vision.
- Multi-position adjustable ball-joint-mounted mirrors.
- Spring-loaded pivots let mirrors fold back completely.
- Sold in pairs.
- Not compatible with Glass Windshield.

### Rear Mirror & Camera Monitor

Maverick, Maverick MAX

715009410



- Fully waterproof rearview mirror and monitor kit.
- See exactly what you need to see with the multiple camera feeds from the rear view camera.
- This unit replaces the stock rearview mirror (the screen is integrated in the unit's replacement rearview mirror).
- The camera uses infrared light for night vision capabilities.

## DOORS

### Aluminum Half Doors

Maverick, Maverick MAX

715007971 · Front

Maverick MAX

715007972 · Rear



- Lightweight half doors made of formed 5/64" (2 mm) thick aluminum.
- Smooth finish.
- Engineered for maximum rigidity and durability.
- Designed for a perfect fit and seamless integration with the vehicle's lines.
- Contoured with a thick seal for better protection from the elements.
- Easy installation using the standard door frame.
- Includes the easy-to-operate Deluxe Door Handles.
- Compatible with the Upper Soft Door Panels, the Window Nets and Upper Door Storage Bags.
- Not compatible with the Lower Door Panel Storage Bags.
- Sold in pairs.

### Deluxe Door Handles

Maverick, Maverick MAX

715004758 · Front

Maverick MAX

715004860 · Rear

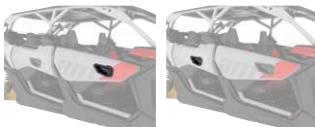

- Convert the standard door straps into easy-to-access door handles.
- Include inside and outside handles for each door.
- Greatly facilitate door opening.
- Standard on accessory Aluminum Half Doors.
- Sold in pairs.

### Lower Door Panels

Maverick, Maverick MAX

715002903 · Front

715003751 · Rear



- Robust injection-molded polypropylene construction designed to match vehicle.
- Extend stock doors at bottom to protect and seal cab area.
- A great-looking add-on.
- Easy and quick installation.
- Sold in pairs.

<b>Window Nets</b>	Maverick	<b>715006693</b> · Front
	Maverick MAX	<b>715004694</b> · Front
	Maverick MAX	<b>715006700</b> · Rear



- Window mesh screen for added protection from wind.
- Can be easily lowered in seconds.
- Sold in pairs.
- Not compatible with Can-Am Audio Roof.

<b>Upper Soft Door Panels</b>	Maverick (except X mr models)	<b>715008091</b> · 2 doors
	Maverick MAX (except X mr models)	<b>715008092</b> · 4 doors



- Weather-resistant panels reinforced with aluminum frame offer good protection from the elements.
- Extend stock quarter doors at the top.
- Made of heavy-duty UV-resistant solution-dyed polyester canvas for excellent resistance to tear and abrasion.
- Zip-down windows made of laminated polished vinyl material for added ventilation.
- To be combined with the Lower Door Panels to obtain complete door kits for your vehicle.
- Not compatible with Racing Side Mirrors and Can-Am Audio Roof.

# SEAT ACCESSORIES

<b>4-Point Harness</b>	Maverick, Maverick MAX	<b>715008033</b> · Driver
		<b>715008034</b> · Passenger



- Exclusive controlled decelerator technology (patent pending) absorbs additional energy in case of accident.
- Designed to offer maximum riding comfort.
- Easy one-click latch and release.
- Patent pending.
- Not EC compliant.

<b>Retractable 4-Point Harness</b>	Maverick, Maverick MAX	<b>715005021</b> · Driver
		<b>715005022</b> · Passenger



- Convenient harness allows you to move freely in your seat, and at the same time fully benefit from the extra support given by the 4-point attachments.
- Makes it easier to buckle up and requires fewer adjustments when switching passenger or driver.
- Retractor Protector (707900653) is required for installation on front seats of MAX models.
- Compatible with rear passenger seats on MAX models.
- Standard on select Maverick models.

<b>Retractor Protector</b> <i>(Not illustrated)</i>	Maverick MAX	<b>707900653</b>
--	--------------	------------------

- Protective pad required for the installation of the Retractable 4-Point Harness on front seat of MAX models.
- Protects the passengers from the retractor mechanism.
- Sold individually.

<b>Seat Belt Shoulder Pads</b>	Maverick, Maverick MAX	<b>715002894</b>
--------------------------------	------------------------	------------------



- Provide additional riding comfort by preventing seat belt from rubbing on neck and shoulder.
- Fit with stock 3-point seat belts and 4 point harness.
- Easy Velcro installation.
- Can-Am branded.
- Sold in pairs for driver and passenger.

# HMWPE SKID PLATES

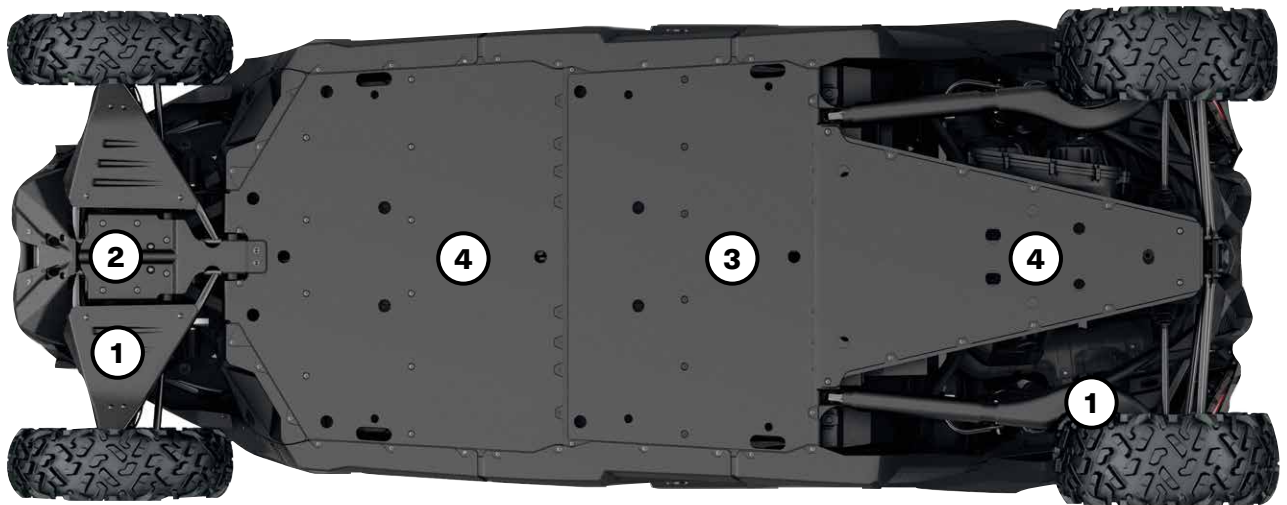

Our plastic plates glide smoothly and silently over obstacles, offering great protection in rough terrain. Made of abrasion-resistant thermoformed  $\frac{3}{8}$ " (10 mm) thick High Molecular Weight Polyethylene (HMWPE).

- Lighter than aluminum.
- Superior stress crack resistance.
- High-impact strength.

## MAVERICK, MAVERICK MAX

HMWPE Skid Plates are standard on Maverick X rc models.	Maverick 64" models	Maverick Max 64" models	Maverick, Maverick Max 72" models (except Base models)	Maverick Base 72" models	Maverick Max Base 72" models
<b>HMWPE Skid Plate Protection Kit</b>					
	715003713	715003747	715003718	715006767	715006769
<b>Individual HMWPE Skid Plates</b>					
① HMWPE Front A-Arm and Trailing Arm Protectors	715002905	715002905	715003552	715003552	715003552
② HMWPE Front Skid Plate	715003933	715003933	715003933	715003933	715003933
③ HMWPE Central Skid Plate	—	715003731	Standard on X rc models only	—	715003731
④ HMWPE Underbelly Plate	715004904	715004904	Standard on X rc models only	715004904	715004904

# BUMPERS & GUARDS

## Bumpers

### Front Pre-Runner Bumper

Maverick, Maverick MAX

■ **715002878** · Black  
■ **715003433** · Can-Am Red



- Made of 1.5" (3.8 cm) diameter steel tubing with a 1/8" (3 mm) aluminum plate for extra durability.
- Inside and outside anti-corrosion coating with durable powder coat finish.
- Added heavy-duty protection in extreme driving conditions.
- Integrated winch mounting plate and mount points for lights.

### Rear Pre-Runner Bumper

Maverick, Maverick MAX

■ **715002880** · Black  
■ **715003436** · Can-Am Red



- Extra-durable 1.5" (3.8 cm) diameter steel tubing with a 1/8" (3 mm) aluminum plate.
- Inside and outside anti-corrosion coating with durable powder coat finish.
- Protects vehicle bodywork and exhaust system.
- Rear Receiver Hitch compatible.
- Required for installation of the Rear Cage Extension.

### Dune Front Bumper

Maverick, Maverick MAX

■ **715002961** · Black  
■ **715003432** · Can-Am Red



- Made of 1.5" (3.8 cm) diameter aluminum tubing with a 1/8" (3 mm) aluminum plate.
- Inside and outside anti-corrosion coating with durable powder coat finish.
- Provides added protection without sacrificing the agility and performance advantages of a lighter weight design.
- Features a more pronounced attack angle and integrated mounting points for lights.
- Not winch compatible.

### Dune Rear Bumper

Maverick, Maverick MAX 2021 & prior  
Maverick, Maverick MAX 2022 & up

■ **715002962** · Black  
■ **715003437** · Can-Am Red  
■ **715009242** · Black



- Made of 1.5" (3.8 cm) diameter aluminum tubing with a 1/8" (3 mm) aluminum plate.
- Inside and outside anti-corrosion coating with durable powder coat finish.
- Provides added protection without sacrificing the agility and performance advantages of a lighter weight design.
- Protects vehicle bodywork and exhaust system.
- Rear hitch compatible.
- Not compatible with Rear Cage Extension and Lonestar Racing Spare Tire Holder.

### X rc/X mr Front Bumper

Maverick, Maverick MAX

■ **715004788** · Black



- Made of 1.5" (3.8 cm) diameter steel tubing with a 1/8" (3 mm) aluminum plate.
- Inside and outside anti-corrosion coating with durable powder coat finish on steel tubing.
- Offers all the essential features required for technical driving: low front-end protection, support base for winch installation and integrated tow hook.
- Standard on Maverick X rc and X mr models.
- Not compatible with winches with steel cable.

### Lonestar Racing Front Bumper

Maverick, Maverick MAX  
(not compatible X mr and X rc models)

■ **715005510** · Hyper Silver  
■ **715005509** · Black



- Made of 1.5" (3.8 cm) diameter steel tubing with durable powder coat finish and a 1/8" (3 mm) thick aluminum plate for added vehicle-front protection in extreme driving conditions.
- Sleek styling enhances the vehicle's race-inspired look.
- Not winch compatible.
- Not compatible with 10" (25 cm) Baja Designs OnX6 LED Light Bar.
- Not compatible with stock Smart-Shox



### Lonestar Racing Rear Bumper

Maverick, Maverick MAX 2021 & prior

- 715005512 · Hyper Silver
- 715005511 · Black
- 715004162 · Can-Am Red



- Made of 1.5" (3.8 cm) diameter steel tubing with durable powder coat finish.
- Provides additional vehicle-rear bodywork and exhaust system protection in extreme driving conditions.
- Sleek styling enhances the vehicle's race-inspired look.
- Compatible with Lonestar Racing Spare Tire Holder.
- Not hitch compatible.

### S3<sup>+</sup> Front Bumper

Maverick, Maverick MAX

- 715004867 · Black



- Made of 1.5" (3.8 cm) diameter steel tubing with a 1/8" (3 mm) aluminum plate for extra durability.
- Inside and outside anti-corrosion coating with durable powder coat finish.
- Added heavy-duty protection in extreme driving conditions.
- Integrated winch support plate and mount points for lights.
- Hook support anchor allows you to keep the winch hook within easy reach when riding in deep mud.
- "S3 for Can-Am" branded.
- Winch not included.

### S3 Rear Bumper

Maverick, Maverick MAX 2021 & prior

- 715004869 · Black



- Made of extra-durable 1.5" (3.8 cm) diameter steel tubing.
- Inside and outside anti-corrosion coating with durable powder coat finish.
- Added heavy-duty protection in extreme driving conditions—protects vehicle bodywork and exhaust system.
- Permits installation of a winch at a higher location to improve accessibility in muddy conditions.
- "S3 for Can-Am" branded.
- Engineered to sustain heavy winch loads without damaging the vehicle's frame.
- Compatible with Can-Am HD and WARN VRX winches—Rear Winch Harness (715006007) is required to install a winch on the bumper.
- Includes a robust recovery hook to facilitate vehicle recovery.
- Winch not included.
- Not EC compliant.

## Rock Sliders

### Rock Sliders

Maverick (except X rc)

- 715002963 · Black
- 715003438 · Can-Am Red

Maverick MAX

- 715003730 · Black
- 715003888 · Can-Am Red



- Made of heavy-duty 1.5" (3.8 cm) diameter steel tubing.
- Inside and outside anti-corrosion coating with durable powder coat finish.
- Protect vehicle's sides and undercarriage against large obstacles.
- Support plate adds rigidity and style.
- Sold in pairs.

### X rc UHMWPE Rock Sliders

Maverick

- 715004730

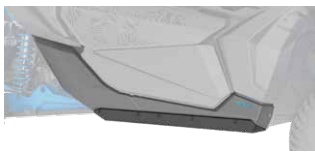

- Robust 1/4" (6 mm) UHMWPE construction.
- Include lower body panels and brackets for installation.
- Protect vehicle's sides and undercarriage against large obstacles.
- Lodge tight up against vehicle body for better clearance from obstacles.
- Slide smoothly over obstacles.
- Sold in pairs.

### Lonestar Racing Rock Sliders

Maverick MAX

- 715005514 · Hyper Silver
- 715008845 · Black
- 715008846 · Can-Am Red
- 715008847 · Black
- 715008848 · Can-Am Red



- Race-engineered to Lonestar Racing's trademark standards for toughness, these stylishly crafted accessories will also enhance your vehicle with visual impact.
- Made of 1.5" (3.8 cm) diameter steel tubing with durable powder coat finish.
- Essential protection for your vehicle's sides from large obstacles.
- Sold in pairs.
- Maverick MAX: Not compatible with the Rear Aluminum Half Doors (715007972).

## Intrusion Bars

### Front Intrusion Bar

Maverick, Maverick MAX

■ **715002889** · Black  
■ **715003435** · Can-Am Red



- Matches vehicle styling.
- Inside and outside anti-corrosion coating with durable powder coat finish steel intrusion bar.
- Tube design reduces obstructed lines of sight and blind spots for better visibility.
- Not compatible with windshields and Lonestar Racing Aluminum Roof.

### Lonestar Racing Front Intrusion Bar

Maverick, Maverick MAX

■ **715003916** · Black



- Made of 1.5" (3.8 cm) diameter steel tubing with durable powder coat finish.
- Enhances the racing look of the vehicle.
- Compatible with Lonestar Racing Aluminum Roof only.
- Not compatible with windshields.

### Lonestar Racing Rear Intrusion Bar

Maverick (except X mr models),  
Maverick MAX

■ **715003918** · Black



- Made of 1.5" (3.8 cm) diameter steel tubing with durable powder coat finish.
- Sleek styling enhances the vehicle's race-inspired look.
- Required for the installation of the Lonestar Racing Spare Tire Holder.
- Not compatible with LinQ mounted accessories and Pre-Filter in the cargo bed.

## Other Accessories

### Fender Flares

Maverick, Maverick MAX

**715002973**



- Extended fender flares made from injection-molded polypropylene.
- Keep mud and debris out of vehicle.
- Designed for quick and easy installation.
- Include front and rear extensions and mounting hardware.

### Lonestar Racing Spare Tire Holder

Maverick, Maverick MAX 2021 & prior  
(except X mr models)

■ **715003922** · Black



- Made of 1.5" (3.8 cm) diameter steel tubing with durable powder coat finish.
- Adjustable height to fit Can-Am tires up to 30 in.
- Requires Lonestar Racing Rear Bumper and Lonestar Racing Rear Intrusion Bar for installation.
- Cannot hold the Pro Armor Quickshot Wheel Jack and Off-Road Screw Jack.
- Wheel not included.
- Not compatible with the S&B Particle Separator and LinQ accessories intended for the rear of the vehicle.

### Lonestar Racing Number Plate Holder

Maverick, Maverick MAX

**715003943**



- Includes a pair of sturdy aluminum number plates that mount on either side of the vehicle rear.
- Not compatible with LinQ Pivoting Rack.
- Numbered decals are available through SCS Unlimited.
- Styling enhances the vehicle's race-inspired look while adding a personal touch.
- Black background.

### S3 Rear Pull Plate

Maverick, Maverick MAX 2021 & prior

■ **715004870** · Black  
■ **715005233** · Can-Am Red



- Offers a solid place to hook onto in case towing is needed.
- Allows you to attach most straps and hooks.
- "S3 for Can-Am" branded.

# LINQ: EASY ON, EASY OFF CARGO

## MAVERICK'S LINQ ACCESSORIES

### Mounting location and requirements

<ul style="list-style-type: none"> <li>No tools needed: Quickly install and remove accessories by hand</li> <li>Equip your Can-Am for specialized tasks in no time</li> <li>Sturdy mounting system that holds up to the roughest terrain</li> </ul>	Standard Cargo Bed	LinQ Pivoting Rack 715008295/715008296	Adventure Roof Rack 715003868/715006225
<b>LinQ Accessories with 16" Base</b> <ul style="list-style-type: none"> <li>LinQ anchors mounted 16 inches apart, center-to-center.</li> <li>Lower loading capacity than the LinQ with 36" base accessories.</li> <li>Can be used on Can-Am ATV and SxS vehicles, Can-Am Spyder and Ryker vehicles, Sea-Doo watercraft and Ski-Doo snowmobiles.</li> </ul>			
<b>LinQ 4.2 Gal Cooler</b> 295100698 • White 219400964 • Black	LinQ Anchor Adapter Kit 715004960	LinQ Anchor Adapter Kit 715004960	LinQ Base Installation Kit 715008125
<b>LinQ Tool Kit</b> 715006829			No further requirements
<b>LinQ Tool Box</b> 715008111			LinQ Base Installation Kit 715008125
<b>LinQ SR 5.5 Gal (21 L) Bag</b> 860202449			
<b>LinQ 4.5 Gal (17 L) Sport Bag</b> 860202447			
<b>LinQ Modular Box</b> 715005494 • (10 L) 715007112 • (20 L) 715006830 • (30 L)			No further requirements
<b>LinQ Roll-Top Bag</b> 715008110	LinQ Base Installation Kit 715008125		
<b>LinQ Accessories with 36" Base</b> <ul style="list-style-type: none"> <li>Mount on LinQ racks often used by Can-Am ORV vehicles.</li> <li>Higher loading capacity than the LinQ with 16" base accessories.</li> <li>Usage is limited to Can-Am ORV vehicles.</li> </ul>			
<b>LinQ 12 Gal (45 L) Cargo Box</b> 715003879	No compatibility	No further requirements	No compatibility
<b>LinQ 23 Gal (86 L) Trunk Box</b> 715004923	No further requirements *Not compatible if the LinQ Pivoting Rack is installed.		
<b>LinQ 32 Gal (121 L) Trunk Box</b> 715001748			
<b>LinQ 11.5 Gal (43 L) Audio Cargo Box</b> 715003018	No further requirements		
<b>LinQ 8 Gal (30 L) Cooler Box</b> 715004778 • Black 715004698 • Gray	No further requirements		
<b>LinQ Premium Storage Bag by OGIO<sup>®</sup></b> 715002923 • Black	No further requirements		
<b>LinQ Heavy Duty Basket</b> 715001215	No further requirements		
<b>LinQ Low Profile Basket</b> 715004282			
<b>LinQ Holders</b>			
<b>LinQ Gear Grips</b> 715005340	No further requirements	No further requirements	Side wall installation LinQ Adapters 715003058
<b>LinQ Tool Holder</b> 715007358			

## LinQ Accessories with 16" Base

### LinQ Modular Box

Maverick, Maverick MAX

715005494 · (10 L)

715007112 · (20 L)

715006830 · (30 L)



- Allows stacking of other modular boxes to always have the right gear accessible.
- Always have the right box size to fit everything.
- Can be installed on any LinQ base with a 16" width.
- See table for installation location and requirements.

### Thermal Insert for LinQ Modular Box (10 L)

Maverick, Maverick MAX

219401110



- Insulated liner.
- Fits very well in the LinQ Modular Box (10 L).
- Can contain seven 355 ml cans.
- Keeps ice cold for one day.
- Interior dimensions: 9" L x 17" W x 2½" H.

### LinQ Tool Box

Maverick, Maverick MAX

715008111



- High precision injected HDPE construction provides rigidity and durability.
- 5 gal (19 L) maximum capacity.
- Weather-resistant, sealed and lockable cover.
- Easy one-second on/off tool-less system.
- All the benefits of LinQ—simple, fast and secure.
- See table for installation location and requirements.

### LinQ Tool Kit

Maverick, Maverick MAX

715006829



- Includes:
  - Cutter pliers
  - Long-nose pliers
  - Locking pliers
  - Ratchet wrench ¾" drive
  - 6" ratchet extension
  - Integrated CVT belt storage location (belt not included)
  - Long-socket 19 mm ¾" drive - 6 pts
  - Socket 18 mm ¾" drive
  - Long-socket 17 mm ¾" drive - 6 pts
  - Socket 15 mm ¾" drive
  - Socket 13 mm ¾" drive
  - Socket 10 mm ¾" drive
  - Socket 8 mm ¾" drive
  - Combined wrench 19 mm
  - Combined wrench 18 mm
  - Combined wrench 15 mm
  - Combined wrench 13 mm
  - Combined wrench 10 mm
  - Combined wrench 8 mm
  - Socket Torx T40 ¾" drive
  - Socket Torx T30 ¾" drive
  - Socket Torx T20 ¾" drive
  - Breaker bar ¾" drive
- See table for installation location and requirements

### LinQ 4.2 Gal (16 L) Cooler

Maverick, Maverick MAX

■ 219400964 · Black  
■ 295100698 · White



- All the benefits of LinQ—simple, fast and secure.
- Rotomolded construction for exceptional rigidity and durability.
- Premium-quality foam insulation for optimal ice retention.
- Uses LinQ mounting system (Patent US 8777531 and US 8875830).
- Easy one-second on/off tool-less system.
- Can contain twenty 355 ml cans.
- Keeps ice cold for three days.
- Exterior dimensions: 13" L x 20" W x 10" H.
- Interior dimensions: 9" L x 17" W x 7" H.
- See table for installation location and requirements.

### LinQ 4.5 Gal (17 L) Sport Bag

Maverick, Maverick MAX

860202447



- 17-liter (4.5 US gallon, 1,037 cu. in.) capacity.
- Rigid bottom, semi-rigid top.
- See table for installation location and requirements.

### SR 5.5 Gal (21 L) LinQ Bag

Maverick, Maverick MAX

860202449



- All the benefits of LinQ—simple, fast and secure.
- Semi-rigid expandable bag.
- 5.5 gal (21 L) capacity.
- Utilizes LinQ mounting system (Patent US 8777531 and US 8875830).
- Easy one-second on/off tool-less system.
- See table for installation location and requirements.



## LinQ Roll-Top Bag

Maverick, Maverick MAX

715008110



- Fully waterproof roll-top dry bag will securely store and confine your equipment.
- LinQ mounted using heavy-duty rigid plastic base.
- High capacity storage solution (40 L).
- Bottom foam liner for additional equipment protection.
- Integrated handle for easy transportation on/off the vehicle.
- Dimensions: 14" L x 19" W x adjustable H.
- See table for installation location and requirements.

## LinQ Accessories with 36" Base

### LinQ 12 Gal (45 L) Cargo Box

Maverick, Maverick MAX

715003879



- LinQ mounted for easy-on, easy-off installation.
- Holds cargo safely and securely while riding.
- See table for installation location and requirements.

### LinQ 23 Gal (86 L) Trunk Box

Maverick (except X mr models),  
Maverick MAX

715004923



- LinQ mounted for easy-on, easy-off installation.
- Holds cargo safely and securely while riding.
- See table for installation location and requirements.

### LinQ 32 Gal (121 L) Trunk Box

Maverick (except X mr models),  
Maverick MAX

715001748 · (No rear tail light)



- Equipped with the LinQ system, the rear trunk box plugs in and out in seconds.
- 32 gal (121 L) load capacity with unobstructed space to maximize storage room and access to the trunk's interior.
- Made of injection-molded polyethylene, double walled in critical areas.
- The fully sealed lid protects your belongings from dust, moisture and the elements.
- No rear tail light.
- Trunk Box Panels available in many colors to match your vehicle (sold separately).
- See table for installation location and requirements.

### LinQ 32 Gal (121 L) Trunk Box Panels

Fit with LinQ 32 Gal (121 L) Trunk Box  
EUROPEAN VERSION (EC compliant)

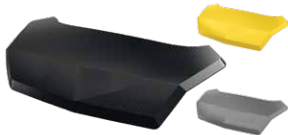

- Color panels to match the LinQ 32 gal (121 L) Trunk Box to your vehicle.
- No rear tail light

■ **715001397** · Black  
■ **715001398** · Yellow  
■ **715002483** · White  
■ **715006121** · Can-Am Red

■ **715006122** · Manta Green  
■ **715006123** · Orange Crush  
■ **715006124** · Viper Red

### LinQ 8 Gal (30 L) Cooler Box

Maverick, Maverick MAX

■ **715004778** · Black  
■ **715004698** · Gray



- LinQ mounted for easy-on, easy-off installation.
- Rotomolded construction provides exceptional rigidity and durability.
- Premium-quality foam insulation for optimal ice retention.
- Integrated, fully removable compartment protects food.
- Robust rubber latches keep the cover tightly closed.
- Weather-resistant.
- Convenient drain plug.
- See table for installation location and requirements.

### LinQ 11.5 Gal (43 L) Audio Cargo Box

Maverick, Maverick MAX

715003018



- An affordable and quick solution for adding music and storage to your next ride.
- The rear installation does not use up any cab space and allows easy listening at an average speed.
- Mounts on/off easily to hold/carry cargo safely and securely.
- Backlit control panel perfect for night riding.
- Water-resistant speakers.
- The Bluetooth<sup>®</sup> enabled receiver and 6.5" (16.5 cm) speakers are smartly concealed and integrated in the cover.
- Automatic shut-off function protects your battery by turning the system off after 10 minutes of inactivity.
- See table for installation location and requirements.

### LinQ Heavy-Duty Basket

Maverick, Maverick MAX

715001215



- Made of high-strength, low-alloy steel.
- LinQ mount for easy-on, easy-off installation.
- See table for installation location and requirements.

### LinQ Premium Storage Bag by OGIO

Maverick, Maverick MAX

■ 715002923 · Black



- Tool-less installation and removal thanks to the LinQ system.
- 17.2 gal (65 L) capacity semi-rigid cargo bag ideal for carrying anything you need on your vehicle.
- Buckle and elastic closure with a rubber seal that protects dust from entering the bag.
- 3-section lid for partial or full access to your bag.
- Inside separators for optimal bag organization.
- See table for installation location and requirements.

### LinQ Low Profile Basket

Maverick, Maverick MAX

715004282



- Low profile, open basket increases cargo space.
- Perfect for easy access to tools, rope, winch and plow accessories.
- Multiple bungee cord and tie-down anchor points.
- Made of impact-resistant injected polypropylene.
- See table for installation location and requirements.

## LinQ Holders

### LinQ Tool Holder

Maverick, Maverick MAX

715007358



- Ultra-versatile tool holder.
- Convenient swivel-latch allows tools to be stored in any orientation.
- Sold in pairs.

### LinQ Gear Grips

Maverick, Maverick MAX

715005340



- Durable and flexible grips provide a custom fit for a variety of items from 1" to 4" (2.5 cm to 10 cm) in diameter.
- Heavy-duty design for carrying bows, fishing poles, rakes, farm tools and more.
- Quick-release button opens grip quickly for easy access to gear.
- Heavy-duty base system built for the toughest adventures.
- Make transporting your tools a snap by combining the LinQ Gear Grips with the LinQ system.
- 360° orientation.
- Sold in pairs.

## LinQ Mounting

### LinQ Anchor Adapter Kit

Maverick, Maverick MAX

715004960



- Allows the installation of LinQ accessories with 16" base on LinQ racks.
- Tool-less installation and removal.

### LinQ Base Installation Kit

Maverick, Maverick MAX

715008125



- Allows installation of compatible LinQ accessories.
- Included: 2 LinQ Cargo bases and hardware.

### Tube LinQ Adapter

Maverick, Maverick MAX

715004292





- Cage mounted LinQ receiver.
- Included in the LinQ Pivoting Rack assembly.
- Allows the installation of single LinQ mounted accessory.
- Diameter: 1.85" (47 mm).

<b>LinQ Lock</b>	Maverick, Maverick MAX	<b>860201968</b>
	<ul style="list-style-type: none"> <li>• Simple way to securely lock most LinQ accessories.</li> <li>• Lock cover protects lock from the elements.</li> <li>• Corrosion resistant.</li> <li>• Pack of 1, includes 2 keys.</li> <li>• Not compatible with LinQ 4.2 US Gal (16 L) Cooler, LinQ Tool Box, LinQ Tool Holder or LinQ Gear Grips.</li> </ul>	

<b>LinQ Replacement Part</b>	Maverick, Maverick MAX	<b>715001707</b>
	<ul style="list-style-type: none"> <li>• Unique mounting fastener usable on any LinQ system accessory.</li> <li>• Tool-less installation and removal.</li> <li>• Sold in pairs.</li> </ul>	

<b>LinQ Adapter</b> <i>(Not illustrated)</i>	Maverick MAX	<b>715003058</b>
<ul style="list-style-type: none"> <li>• Allows the installation of the LinQ Tool Holder on the Adventure Roof Rack.</li> <li>• Sold in pack of 4.</li> </ul>		

<b>Cargo Box Net</b>	Maverick, Maverick MAX	<b>715001371</b>
	<ul style="list-style-type: none"> <li>• Solid net designed to secure and ensure the compact confinement of your Adventure Roof Rack.</li> </ul>	

<b>Spare Tire Ratchet Tie-Downs</b>	Maverick, Maverick MAX	<b>280000955</b>
	<ul style="list-style-type: none"> <li>• 3-way ratcheting tie-down strap with loop ends.</li> <li>• Designed to securely hold spare tires on accessories equipped with integrated spare tire attachment points.</li> <li>• Adjustable to accommodate most common UTV tire sizes.</li> <li>• Ratchet and junction ring made of durable zinc-plated steel.</li> <li>• Required for spare tire attachment on Adventure Roof Rack.</li> </ul>	

# RACKS & STORAGE

## Racks

<b>LinQ Pivoting Rack</b>	Maverick, Maverick MAX (except X mr models)	<ul style="list-style-type: none"> <li>■ <b>715008295</b> - Black</li> <li>■ <b>715008296</b> - Can-Am Red</li> </ul>
	<ul style="list-style-type: none"> <li>• LinQ latched rack allows for extra LinQ mounted accessories or for carrying a spare tire (tire not included).</li> <li>• Includes custom tie-down strap for fast spare tire installation or removal (tire not included).</li> <li>• Gas-cylinder pivot action, locks in the raised position.</li> <li>• Trunk Boxes over 20 gal (74 L) do not fit on the vehicle when the rack is installed.</li> <li>• Not compatible with Rear Intrusion Bars, Rear Cage Extension and Lonestar Racing Aluminum Roofs.</li> </ul>	

<b>Adventure Roof Rack</b>	Maverick Maverick MAX	<ul style="list-style-type: none"> <li><b>715006225</b></li> <li><b>715003868</b></li> </ul>
	<ul style="list-style-type: none"> <li>• Ideal cargo solution for packing everything you need to live your Off-Road experience fully and completely.</li> <li>• Built with lightweight 1.25" (3.2 cm) diameter steel tubing.</li> <li>• Integrated mounting points for lights can hold up to eight pod-type LED lights (six front and two back) or a 40" (102 cm) LED bar (front).</li> <li>• Features anchor points for spare-tire attachment.</li> <li>• LinQ anchor on both sides.</li> <li>• Spare Tire Tie-Downs sold separately.</li> <li>• Add the Cargo Box Net to secure and confine your cargo in the rack.</li> <li>• Loads up to 75 lb (34 kg).</li> </ul>	

## NEW Adventure Roof Rack

Maverick

715007186



- The ideal cargo solution. Pack all the gear you need to take on any off-road experience.
- Built using lightweight 1.25" (3.2 cm) diameter steel tubing.
- Supports loads of up to 75 lb (34 kg).
- This roof rack features a height adjustment setting to precisely accommodate a stock roof.
- Integrated mounting points for lights.
- Features anchor points for a spare tire attachment.
- LinQ anchor on both sides.
- The Spare Tire Tie-Downs sold separately.
- Sport roof or Aluminum roof is required for installation.

## Storage

### Shoulder Storage Bag

Maverick (except X mr models),  
Maverick MAX (rear only)

715004277



- Bag attaches in unused space between the seats to increase your vehicle's cargo capacity.
- Installs between the rear seats only on MAX models.

### Front Shoulder Storage Bag

Maverick MAX

715004888

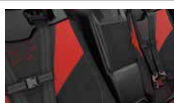

- Opens on each side so that both front and rear passengers can access the bag's content.
- Installs between the driver and passenger seats on MAX models.

### Overhead Storage Bag

Maverick, Maverick MAX

715004275



- Weather-resistant bag, holds your gear safely and securely while riding.
- Makes smart use of your overhead space to increase your vehicle's cargo capacity by 2.6 gal (10 L).
- Semi-rigid construction renders it flexible enough to fit odd-shaped loads.
- Touchscreen-compatible clear front pocket allows for easy access to your smartphone.
- Not compatible with the Bimini Roof.

### Upper Door Storage Bags

Maverick, Maverick MAX

715004276



- Weather-resistant, they'll hold your gear safely and securely while riding.
- Bags attach on stock quarter doors to increase your vehicle's cargo space.
- Each bag is designed as a 1.3 gal (5 L) capacity pocket also equipped with inner netting compartments.
- Semi-rigid construction renders them flexible enough to fit odd-shaped loads.
- Sold in pairs.

### Lower Door Panel Storage Bags

Maverick, Maverick MAX

715004355



- Weather-resistant, they'll hold your gear safely and securely while riding.
- Bags attach on Lower Door Panels to increase your vehicle's cargo space.
- Each bag is designed as a 1.6 gal (6 L) capacity pocket also equipped with inner netting compartments.
- Semi-rigid construction renders them flexible enough to fit odd-shaped loads.
- Sold in pairs.
- Not compatible with aluminum doors and Off-Road Screw Jack.
- Lower add-on doors required for installation.

### Soft Storage Bag

Maverick, Maverick MAX

715003759



- 11.8 gal (45 L) capacity soft cargo bag designed with vehicle's rear in mind to maximize potential storage.
- 3 sections.
- Weatherproof.

### Storage 2.6 Gal (10 L) Bag

Maverick, Maverick MAX

269502121



- Roll-top dry bag for fully protecting your cargo from the elements.





- This weather-resistant bag holds your gear safely and securely while you ride.
- Bag settling on the passenger seat to increase the vehicle's cargo capacity.
- This bag features a 14.5 gal (55 L) storage capacity and is divided into two compartments.
- The top compartment is insulated to keep your beverages cold and includes two cup holders.
- Additional pocket inside for additional storage, such as a cell phone.
- The bottom compartment is accessible from both sides and serves as a large pocket for storing various items.
- The detachable pocket at the front of the bag can be used as a garbage bag.

# LIGHTS

		<b>2 Choose your lights</b>								
<b>1 Choose your mount point</b>	<b>BAJA DESIGNS<sup>†</sup> LIGHTS</b>					<b>CAN-AM LIGHTS</b>				
	10" (25 cm) LED Light Bar	40" (102 cm) Baja Design OnX6 Arc LED Light Bar	XL Sport LED Lights (sold in pairs)	Squadron Sport LED Lights (sold in pairs)	XL80 LED Lights (sold in pairs)	10" Double Stacked LED Bar	15" Double Stacked LED Bar	39" Double Stacked LED Bar	4" Round LED Lights (sold in pairs)	3.5" Spot or Flood LED Lights (sold in pairs)
<b>Front Pre-Runner or Dune Bumpers</b>	710006819 + 715007049 (Power Cable)	710006818 + 715007117 (Power Cable)	710006821 + 715002884 (Power Cable)	710006820 + 715002884 (Power Cable)	710005041 + 715007049 (Power Cable)	715002933 + 715003417 (Power Cable)	715002934 (Not compatible with Pre-Runner Bumper) + 715003417 (Power Cable)		715002935 (4" Round), 715003665 (3.5" Flood) or 715003666 (3.5" Spot) + 715003417 (Power Cable)	
<b>Lonestar Racing Front Bumper</b>	NA	710006818 + 715007117 (Power Cable)	710006821 + 715002884 (Power Cable)	710006820 + 715002884 (Power Cable)	710005041 + 715007049 (Power Cable)				715002935 (4" Round), 715003665 (3.5" Flood) or 715003666 (3.5" Spot) + 715003417 (Power Cable)	
<b>Light Support Bar or Adventure Roof Rack</b>	710006819 + 715007049 (Power Cable)	710006818 + 715007117 (Power Cable)	710006821 + 715002884 (Power Cable)	710006820 + 715002884 (Power Cable)	710005041 + 715007049 (Power Cable)	715002933 + 715003417 (Power Cable)	715002934 + 715003417 (Power Cable)	715004007 + 715005822 (Light Mounting Kit)	715002935 (4" Round), 715003665 (3.5" Flood) or 715003666 (3.5" Spot) + 715003417 (Power Cable)	
<b>Lonestar Racing 40" (102 cm) LED Light Bar Rack</b>	NA	710006818 + 715007117 (Power Cable)	NA	NA	NA	NA	NA	NA	NA	NA
<b>Lonestar Racing Light Rack</b>	NA	NA	710006821 + 715002884 (Power Cable)	NA	710005041 + 715007049 (Power Cable)	NA	NA	NA	NA	NA

**3 Order** **Order all part numbers in intersecting box**  
*\*Note: When installing more than one light kit, additional light power cable or mounting kit is required.*

\*All lights are intended for off-road use only.

<b>Lights Power Cable</b> <i>(Not illustrated)</i>		<b>715003417</b>
		<b>715007049</b>
		<b>715002884</b>
		<b>715007117</b>
	Maverick, Maverick MAX	

- Required for installation of Baja Designs LED lights onto roof or bumper.
- 10" (25 cm) Baja Designs OnX6 LED Bars and Baja Designs XL80 LED Lights (715007049).
- Baja Designs XL Sport LED Lights and Baja Designs Squadron Sport LED Lights (715002884).
- 40" (102 cm) Arc LED Light Bar ONX6 (715007117).

**40" (102 cm) Baja Designs OnX6 Arc LED Light Bar**

Maverick, Maverick MAX

**710006818**

29,000  
lumens

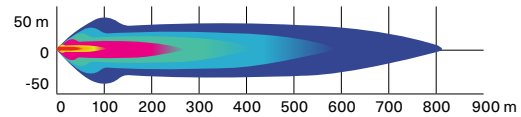

- 252 W light bar producing 29,000 lumens.
- Equipped with 24 Cree XM-L2 LEDs.
- Driving/combo light pattern for smooth blend of light for both near field applications and distance.

- Designed for installation onto Light Support Bar equipped roofs.
- Requires Light Power Cable and Light Support Bar.
- See table for installation location and requirements.

**Baja Designs 10" (25 cm) OnX6 LED Light Bar**

Maverick, Maverick MAX

**710006819**

12,460  
lumens

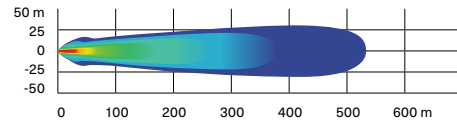

- 108 W light bar producing 12,460 lumens.
- Equipped with 6 Cree XM-L2 LEDs.
- Driving/combo light pattern for smooth blend of light for both near field applications and distance.

- Dual intensity (high/low) settings.
- Requires Baja Designs Light Power Cable.
- See table for installation location and requirements.

**Baja Designs XL80 LED Lights**

Maverick, Maverick MAX

**710005041**

9,500  
lumens

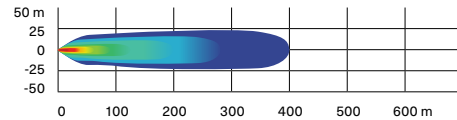

- 80 W per spot producing 9,500 lumens.
- Equipped with 4 Cree XHP50 LEDs per spot.
- Dual intensity (high/low) settings.
- Driving/combo light pattern for smooth blend of light for both near field applications and distance.

- Require Baja Designs Light Power Cable.
- Sold in pairs.
- Dimensions: 4.5" x 4.5" (11.4 cm x 11.4 cm).
- See table for installation location and requirements.

**Baja Designs Squadron Sport LED Lights**

Maverick, Maverick MAX

**710006820**

3,150  
lumens

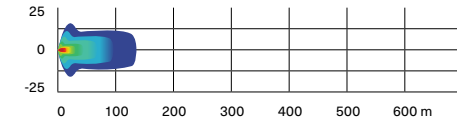

- 26 W per spot producing 3,150 lumens.
- Equipped with 4 Cree XP-G2 LEDs per spot.
- Wide cornering light pattern designed specifically for cornering, dust and/or fog conditions.

- Require Baja Designs Light Power Cable.
- Sold in pairs.
- Dimensions: 3" x 3" (7.6 cm x 7.6 cm).
- See table for installation location and requirements.

**Baja Designs XL Sport LED Lights**

Maverick, Maverick MAX

**710006821**

3,150  
lumens

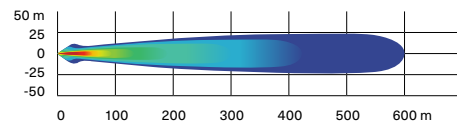

- 26 W per spot producing 3,150 lumens.
- Equipped with 4 Cree XP-G2 LEDs per spot.
- High Speed Spot features a longer and narrower beam focus for illumination farther down.

- Require Baja Designs Light Power Cable.
- Sold in pairs.
- Dimensions: 4.5" x 4.5" (11.4 cm x 11.4 cm).
- See table for installation location and requirements.

**10" (25 cm) Double Stacked LED Light Bar (60 W)**

Maverick, Maverick MAX

**715002933**

**5,400 lumens**

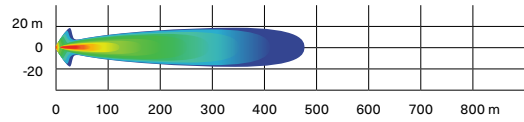

- Equipped with twelve 5 W Cree LEDs.
- 5,400 lumens.
- Packs a big punch for its size.
- Rugged and waterproof.
- Requires light power cable for installation.

- Lights up to more than 1,500 ft. (460 m) in front of the vehicle and around 65 ft. (20 m) wide on each side.
- See table for installation location and requirements.

**15" (38 cm) Double Stacked LED Light Bar (90 W)**

Maverick, Maverick MAX

**715002934**

**8,400 lumens**

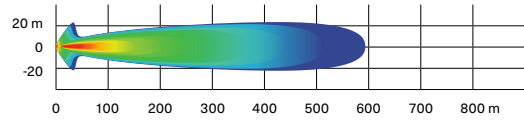

- Equipped with 18 5 W Cree LEDs.
- 8,400 lumens.
- Complements the Light Racks and most bumpers.
- Rugged and waterproof.

- Lights up to more than 1,900 ft. (580 m) in front of the vehicle and around 65 ft. (20 m) wide on each side.
- See table for installation location and requirements.

**39" (99 cm) Double Stacked LED Light Bar (270 W)**

Maverick, Maverick MAX

**715004007**

**24,300 lumens**

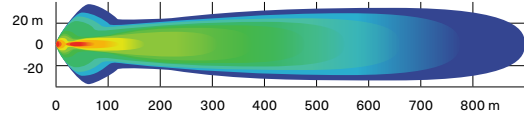

- Equipped with 54 5 W Cree LEDs.
- 24,300 lumens.
- Lights up to more than 2,900 ft. (900 m) in front of the vehicle and around 115 ft. (35 m) wide on each side.

- Compatible on the Adventure Roof Rack.
- Requires light power cable for installation.

**4" (10 cm) Round LED Lights (2 x 25 W)**

Maverick, Maverick MAX

**715002935**

**1,800 lumens**

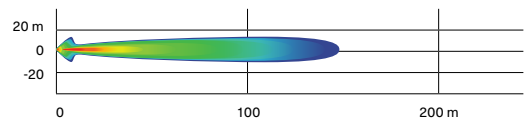

- 25 W LED spotlights.
- 1,800 lumens.

- Rugged and waterproof.
- Includes basic wiring and switch.

- Can-Am branded grill.
- Requires light power cable.
- Sold in pairs.

- Not EC compliant.
- Requires light power cable for installation.

**3.5" (9 cm) LED Driving Lights (2 x 14 W)**

Maverick, Maverick MAX

**715003666**

**1,260 lumens**

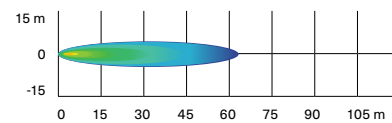

- 14 W LED lights producing 1,260 lumens each.
- Spot lens for a narrow and long light beam spread, ideal when driving at higher speeds.
- Equipped with six high-power LEDs in a heavy-duty die-cast aluminum housing.

- Features two attachment points. If one attachment point fails due to a collision, rotate to the next channel point and remount the light.
- Sold in pairs.
- CE certified
- Requires light power cable for installation.

### 3.5" (9 cm) LED Flood Lights (2 x 14 W)

Maverick, Maverick MAX

715003665

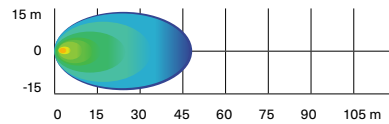

- 14 W LED lights producing 1,260 lumens each.
- Flood lens for a wide light beam spread, ideal for working applications like plowing or cornering. Suitable for dusty or foggy riding conditions.
- Equipped with six high-power LEDs in a heavy-duty die-cast aluminum housing.
- Features two attachment points. If one attachment point fails due to a collision, rotate to the next channel point and remount the light.
- Sold in pairs.
- CE certified
- Requires light power cable for installation.

### Can-Am LED Signature Lights

Maverick, Maverick MAX

715003673



- Add style with a more aggressive look.
- Use bright and energy efficient LEDs.
- Do not give additional lighting for driving.

### Dome Light

Maverick, Maverick MAX

715002455



- LED array integrates perfectly with vehicle.
- Wiring included.
- Can be installed on cage, Sport Roof or All-Terrain Trunk Cover.

### Lonestar Racing 40" (102 cm) LED Light Bar Rack

Maverick, Maverick MAX

715003920



- Designed for use with 40" (102 cm) Baja Designs OnX6 Arc LED Light Bar.
- Enhances the vehicle's race-inspired look.
- Compatible with Aluminum Roof, Lonestar Racing Aluminum Roof and Sport Roof.
- Not compatible with Racing Side Mirrors and PowerFlip Windshield.
- Lights sold separately.

### Lonestar Racing Light Rack

Maverick, Maverick MAX

715003948



- Designed for use with Baja Designs XL80 LED Light and Baja Designs XL Sport LED Light.
- Accommodates up to two pairs of XL Lights.
- Not compatible with Racing Side Mirrors and PowerFlip Windshield.
- Compatible with Lonestar Racing Aluminum Roof, Aluminum Roof and Sport Roof.
- Lights sold separately.

### Chase Lights

Maverick, Maverick MAX

715002887



- Designed by Can-Am to make you visible to vehicles riding behind you, especially in dusty or harsh conditions.
- Feature in-dash switches to activate one of the two modes and to choose among 11 different high-visibility colored light patterns (blue, red and yellow).
- Trail Mode: Serves as a tail light and as a brake light.
- Race Mode: Displays light patterns and serves as a brake light (brake light function can be deactivated for racing applications).
- Modular to allow installation with rear roll cage mounted accessories.
- Plug-and-play installation.

### NEW LED Chase Lights



Maverick, Maverick MAX

715009887







- Designed by Can-Am to make you visible to vehicles riding behind you, especially in dusty or harsh conditions.
- High-visibility colored light patterns (red, yellow, white).
- Three modes available:
  - Trail Mode: serves as a tail light and as a brake light.
  - Chasing Mode: displays amber light pattern.
  - Work Mode: white light to light up your cargo bed.
- Modular to allow installation with rear roll cage mounted accessories.
- Plug-and-play installation.
- Wiring harness required (715008210).
- Sold separately.





<b>Light Support Bar</b>	Maverick, Maverick MAX	<b>715003529</b>
	<ul style="list-style-type: none"> <li>• Sleekly styled rugged aluminum construction.</li> <li>• Accommodates light bars and spotlights with or without any roof and windshield combination.</li> <li>• Full vehicle width to allow the installation of any large LED light bar.</li> <li>• Required for light installation on vehicle's roof.</li> <li>• Not compatible with Lonestar Racing Aluminum Roof.</li> <li>• Lights sold separately.</li> </ul>	
<b>Mounting Kit for 39" (99 cm) LED Light Bar</b> <i>(Not illustrated)</i>	Maverick, Maverick MAX	<b>715005822</b>
<ul style="list-style-type: none"> <li>• Required for installation of the 39" (99 cm) double stacked LED Light Bar.</li> <li>• Includes wiring and support bracket.</li> <li>• Light Support Bar required for installation.</li> </ul>		
<b>Light Power Cable</b> <i>(Not illustrated)</i>	Maverick, Maverick MAX	<b>715003417</b>
<ul style="list-style-type: none"> <li>• Required for installation of 10" (25 cm), 15" (38 cm) and Double Stacked LED Light Bars and 4" (10 cm) Round LED Lights.</li> <li>• For bumper and roof mounting locations.</li> </ul>		
<b>NEW Integrated LED Side Mirror Lights</b>	Maverick, Maverick MAX	<b>715007185</b>
	<ul style="list-style-type: none"> <li>• Light up corners.</li> <li>• Increase the width of the beams and illuminate the wheels for increased visibility.</li> <li>• Wide flood beam.</li> <li>• 3,000 lumens for each light.</li> <li>• Require Aluminum Side Mirrors (715007363).</li> <li>• Electric Harness (715008212) required to hook up and operate the Integrated LED Side Mirror Lights (715007185) for on/off function when ACM is not installed.</li> <li>• Wiring Harness (715008212) is required for installation.</li> </ul>	

# AUDIO & COMMUNICATION SYSTEMS

## Audio

<b>Can-Am Audio Roof</b>	Maverick	<b>715007130</b>
	<ul style="list-style-type: none"> <li>• Full roof with sleek built-in audio.</li> <li>• Fully sealed and waterproof.</li> <li>• Easy to install: one wire connects the roof to the vehicle's electronics.</li> <li>• Four 8" speakers, one 400 RMS and 800 peak watt amplifier, and one Head Unit supplied by Rockford Fosgate Audio.</li> <li>• Multi-colored RGB LED accent lighting around each speaker.</li> <li>• 2.7" color display with Bluetooth and Pandora connectivity.</li> <li>• Flip Kit-compatible.</li> <li>• Not compatible with the Adventure Roof Rack if the Flip Kit is installed.</li> <li>• Not compatible with the Upper Soft Door Panels.</li> </ul>	
<b>Can-Am Audio Roof</b>	Maverick MAX	<b>715006709</b>
	<ul style="list-style-type: none"> <li>• Full roof with built-in audio.</li> <li>• Fully sealed and waterproof.</li> <li>• Easy to install, one wire connects the roof to the vehicle's electric system.</li> <li>• Six 8" speakers, one 400 RMS and 800 peak watt amplifier, one Head Unit calibrated by Rockford Fosgate Audio.</li> <li>• Multi-colored RGB LED accent lighting around each speaker.</li> <li>• 2.7" color Display with Bluetooth and Pandora connectivity.</li> <li>• Not compatible with the Adventure Roof Rack if the Flip Kit is installed.</li> <li>• Not compatible with the Upper Soft Door Panels.</li> </ul>	
<b>Can-Am Audio Roof Flip Kit</b>	Maverick, Maverick MAX	<b>715007131</b>
	<ul style="list-style-type: none"> <li>• Combines with Audio Roof (715007130 or 715006709) for Flip option.</li> <li>• Not compatible with the Racing Side Mirrors (715002898).</li> </ul>	
<b>MTX Central Speakers</b>	Maverick MAX	<b>715004748</b>
	<ul style="list-style-type: none"> <li>• Top mounted central speaker case holding two 6.5" (16.5 cm)/100W speakers.</li> <li>• Designed to be Can-Am-tough in the most demanding riding conditions.</li> <li>• Perfect add-on to the Complete MTX Audio System for a 7-speaker system or as a stand-alone system by plugging the AUX input jack directly into your music device.</li> <li>• Not compatible with Lonestar roofs.</li> </ul>	

<b>Complete MTX Audio System</b>	Maverick, Maverick MAX	<b>715002873</b>
	<ul style="list-style-type: none"> <li>Bluetooth 5' equipped 400 W RMS/800 W peak audio system by MTX.</li> <li>Designed to be Can-Am-tough in the most demanding riding conditions.</li> </ul>	<ul style="list-style-type: none"> <li>Includes front-dashboard and rear-roll-cage mounted stereo speakers and head unit with an integrated 6.5" (16.5 cm) subwoofer.</li> <li>Add the Electronic Device Holder to securely hold your Bluetooth device ready to play your favorite tunes.</li> </ul>

<b>Can-Am Subwoofer</b>	Maverick, Maverick MAX	<b>715004956</b>
	<ul style="list-style-type: none"> <li>Powerful Rockford Fosgate Underseat 10" Subwoofer speaker box.</li> <li>Easy plug-and-play connections to Audio Roof system.</li> <li>Sturdy construction tough enough to withstand harsh environments and sealed against moisture and dirt.</li> </ul>	<ul style="list-style-type: none"> <li>Requires 1 Amplifier Kit (715007227) for 1 or 2 subwoofers.</li> <li>Fits two per vehicle: under driver or passenger seat.</li> <li>Wiring included.</li> </ul>

<b>Can-Am Amplifier Kit</b>	Maverick, Maverick MAX	<b>715007227</b>
	<ul style="list-style-type: none"> <li>A powerful 400 W amplifier to feed up to two Underseat Subwoofers.</li> <li>Easy plug-and-play connections to Audio Roof system and subwoofer.</li> <li>Installation plate and wiring included.</li> </ul>	

<b>Electronic Device Holder</b>	Maverick, Maverick MAX	<b>715002874</b>
	<ul style="list-style-type: none"> <li>A great in-ride entertainment system platform.</li> <li>Robust injected-polypropylene construction allows for right fit and easy installation.</li> <li>Adjustable unit safely holds most tablets and smartphones measuring between 5.1" (13 cm) and 10" (25.4 cm) (with protective case).</li> </ul>	<ul style="list-style-type: none"> <li>Combines seamlessly with Complete MTX Audio System and Rugged Radios Intercom System.</li> <li>Allows the installation of Garmin Montana 680T GPS.</li> <li>Integrated storage (1 gal [3.8 L] capacity) with access to the dash 12V outlet for device charging.</li> </ul>

## Communication Systems

<b>Rugged Radios Helmet Headset Kit for Rear Passengers</b>	With Rugged Radios Intercom System	<b>715004380 · US ONLY</b>
	<ul style="list-style-type: none"> <li>Additional 12' (3.7 m) cables and Helmet Speaker/Mic Kits to upgrade your 2-person intercom system to a 4-person system.</li> <li>Power Cable is required for installation on MAX models.</li> </ul>	

# ELECTRICAL & ELECTRONIC ACCESSORIES

## Electrical

<b>Seat Heater</b>	Maverick, Maverick MAX	<b>715006112</b>
	<ul style="list-style-type: none"> <li>25 W seat heater delivers chill-free riding comfort.</li> <li>High/low temperature settings allow you to control the desired degree of warmth.</li> <li>This kit includes one carbon fiber seat heater, foam sheet and in-dash switch.</li> <li>Installs directly in the original seat cushion.</li> <li>Heated Accessories Wiring Harness (710005757) is required for front seat installation.</li> <li>Heated Accessories Wiring Harness (715006004) is required for rear seat installation.</li> </ul>	

<b>Heated Visor Outlet</b>	Maverick, Maverick MAX	<b>715001246</b>
	<ul style="list-style-type: none"> <li>Strategically positioned on vehicle to maintain your agility.</li> <li>Optional visor outlet that delivers fog-free riding.</li> <li>Quick and easy installation.</li> <li>Sold individually.</li> <li>Heated Visor not included.</li> </ul>	

### Heated Accessories Wiring Harness

(Not illustrated)

Maverick, Maverick MAX

710005757

- Electric harness required to hook up and operate front heated seats, heated steering wheel and heated grab bar.
- Heated Accessories Wiring Harness (715006004) is required for rear seat installation.

### Auxiliary Battery Installation Kit

(Not illustrated)

Maverick, Maverick MAX

715006315

- Allows you to add a second 18Ah battery for a dual battery setup necessary to power auxiliary electrical components such as sound systems or winches.
- Equipped with an IP67-rated waterproof electronic module that will prevent your auxiliary electrical components from draining your starting battery.
- Kit includes an additional battery junction block, all necessary wiring and the battery holder.
- Both batteries are perfectly integrated, in stock location, behind the passenger seat.
- Additional battery (410301203), plus battery hardware (250000282) sold separately.

## Electronic

### NEW Cellphone Holder

Maverick, Maverick MAX

715008786



- Water resistant door allows for perfect phone positioning.
- Features capacitive and resistive touch screen technology.
- Spring system in back plate automatically adjusts for thickness.
- Fits all cellphones within 7.2" (185 mm) x 3.3" (85 mm) x 0.6" (15 mm) dimensions.
- Works with almost all charger wires.
- Does not include cellphone or charging wires.
- Requires the Electronic Device Holder (715002874) for the Cellphone Holder to be bolted on its door.

### Lighted Whip Flag

Maverick, Maverick MAX

715002886



- A must for riding the dunes.
- 5 W Cree LED.
- 5 colored lenses to allow personalization.
- Glow-through whip, quickly removable and replaceable pole.
- Increases vehicle's visibility.
- Meets most dune-area requirements.
- Die cast aluminum base, acetal hand nut.
- Includes mounting brackets and wiring.
- 4' (1.2 m) flag mounts on top of the roll cage.
- Can be installed on both sides of a vehicle.

### Digitally Encoded Security System (D.E.S.S.) Green Key

Maverick  
(Turbo/TurboR/Turbo RR motorization)

710005232



- Top-security anti-theft protection for your vehicle.
- Encrypted chip technology restricts access to your vehicle's electronic ignition system.
- One vehicle/one code.
- A vibration/shock-resistant ball-and-socket design that ensures a reliable connection.
- 3 programmable modes:
  - Work mode: Limits vehicle speed to 40 kph (25 mph) but does not limit engine torque.
  - Normal mode: Limits vehicle speed to 70 kph (44 mph) and 50% torque reduction.
  - Performance mode: No restrictions.

# WINCHES & HITCHES

## Can-Am HD Winches

### Can-Am HD 4500 Winch

Maverick, Maverick MAX

715006416



- Ergonomic clutch handle.
- Rugged all-steel gears and bushings for more torque and durability.
- Automatic 100% load-holding brake.
- Sealed solenoid for all-weather protection.
- Weather sealed corded remote and dash mounted switch.
- EC compliant.
- Pulling strength capability of 4,500 lb (2,041 kg).
- 43' of 1/8" (13.1 m of 6.3 mm) wire steel cable.
- Heavy-duty 4-way roller fairlead.
- Winch Electrical Harness (715003585) and winch compatible front bumper are required.

### Can-Am HD 4500-S Winch

Maverick, Maverick MAX

715006417



- Ergonomic clutch handle.
- Rugged all-steel gears and bushings for more torque and durability.
- Automatic 100% load-holding brake.
- Sealed solenoid for all-weather protection.
- Weather-sealed corded remote and dash mounted switch.
- Pulling strength capability of 4,500 lb (2,041 kg).
- 50' of 1/4" (15.2 m of 6.35 mm) synthetic rope.
- Corrosion-proof aluminum hawse fairlead.
- Winch Electrical Harness (715003585) and winch compatible front bumper are required.

## WARN<sup>†</sup> VRX Winches

### WARN VRX 45 Winch

Maverick, Maverick MAX

715006110



- Extreme IP68-rated waterproof sealing keeps the elements out.
- Durable all-metal construction.
- Black powder-coated finish and stainless steel fasteners for corrosion resistance.
- Robust new clutch design based on 70+ years of WARN 4 WD hub lock know-how.
- Load-holding brake for great control.
- Smooth and reliable all-metal three-stage planetary gear train.
- Dash-mounted rocker control.
- Limited lifetime warranty (mechanical), 3-year warranty (electrical).
- Pulling strength capability of 4,500 lb (2,041 kg).
- 50' of 1/4" (15 m of 6.3 mm) wire steel cable.
- Roller fairlead.
- Winch Electrical Harness (715003585) and winch compatible front bumper are required.

### WARN VRX 45-S Winch

Maverick, Maverick MAX

715006111



- Extreme IP68-rated waterproof sealing keeps the elements out.
- Durable all-metal construction.
- Black powder-coated finish and stainless steel fasteners for corrosion resistance.
- Robust new clutch design based on 70+ years of WARN 4 WD hub lock know-how.
- Load-holding brake for great control.
- Smooth and reliable all-metal three-stage planetary gear train.
- Dash-mounted rocker control.
- Limited lifetime warranty (mechanical), 3-year warranty (electrical).
- Pulling strength capability of 4,500 lb (2,041 kg).
- 50' of 1/4" (15 m of 6.3 mm) synthetic rope.
- Cast aluminum hawse fairlead.
- Winch Electrical Harness (715003585) and winch compatible front bumper are required.

## Winch Accessories

### Can-Am HD Hawse Fairlead

Can-Am HD Winch

715006426



- A must when upgrading your winch with a synthetic cable, this corrosion-proof aluminum hawse fairlead will prevent the cable from snapping in a corner of a roller fairlead and from wearing prematurely due to the rough surface of the worn roller guide.
- Must be used with synthetic cables only.

### WARN Hawse Fairlead

WARN Winch

715007785



- Double-powder-coated construction.
- Required to use the Synthetic Winch Cable (715001118) on WARN winches.
- To be used with synthetic winch cables only.

### Synthetic Winch Cable

Can-Am HD Winch

715006430

WARN Winch

715007783



- 50' of 1/4" (15.2 m of 6.35 mm) synthetic cable for Can-Am HD winches.
- Can-Am HD Hawse Fairlead (715006426) is required when upgrading to a synthetic cable to avoid premature cable damage and wear.
- WARN Hawse Fairlead (715007785) is required when upgrading to a synthetic cable to avoid damage and premature wear of the cable.



<b>Wire Rope Replacement</b>	Can-Am HD Winch	<b>705014978</b>
	WARN Winch	<b>715006699</b>



- 43' of 1/4" (11.3 m of 6.3 mm) wire rope for Can-Am HD Winch.
- 55' of 1/4" (16.8 m of 6.35 mm) wire rope for WARN winch kit.
- 4,500 lb (2,041 kg) pulling strength.

<b>Synthetic Cable Extension</b>		<b>715001120</b>
----------------------------------	--	------------------



- Lightweight 1/4" (6.35 mm) diameter, easy to handle and won't rattle in cargo box.
- Easily attaches to winch cable to provide additional 50' (15.2 m) of distance.
- 4,500 lb (2,041 kg) single line capacity.

<b>Winch Electrical Harness</b> <i>(Not illustrated)</i>	Maverick, Maverick MAX	<b>715003585</b>
---	------------------------	------------------

- Required for winch installation.

<b>Rear Winch Harness</b> <i>(Not illustrated)</i>		<b>715006007</b>
---	--	------------------

- Required for installation of a winch on the S3 Rear Winch Bumper.

<b>Wired Remote Control</b>	Can-Am HD Winch*	<b>715006504</b>
-----------------------------	------------------	------------------



- This kit allows winch owners to add the hand-held remote to vehicles with a stock winch.
- OEM stock winch is sold separately.
- EC compliant.

† *Harness (710001023) is required to use remote control on a vehicle with a factory installed winch.*  
‡ *Remote control (710007050) and connection socket are included.*

<b>Wireless Remote Control</b>	WARN Winch	<b>715002542</b>
--------------------------------	------------	------------------



- The system is quick and easy to install, thanks to a wiring harness with an integrated antenna and all necessary mounting hardware.
- The system allows you to operate your winch from anywhere within a 50' (15.2 m) radius, increasing your recovery options.
- All components are weatherproof.

<b>X rc/X mr Rear Tow Hook</b>	Maverick, Maverick MAX 2021 & prior	<b>715004450</b>
--------------------------------	-------------------------------------	------------------



- Offers a solid place to hook onto in case towing is needed.
- Allows you to attach most straps and hooks.
- Made of rugged 3/8" (9.5 mm) steel plate and 5/8" (16 mm) steel hook tube.
- Standard on Maverick X rc and X mr models.

## Hitches

<b>Rear Hitch</b>	Maverick, Maverick MAX 2021 & prior	<span style="color: black;">■</span> <b>715002883</b> · Black <span style="color: red;">■</span> <b>715003938</b> · Can-Am Red
-------------------	-------------------------------------	---



- Rugged lightweight steel construction.
- E-coated finish.
- Fixed mounting point for trailer ball to provide vehicle with towing capabilities.
- This hitch offers 1,300 lb (590 kg) of towing capacity.
- Hitch ball not included.

<b>Front and Rear Hitch Drawbar</b>	Maverick, Maverick MAX	<b>715008350</b>
-------------------------------------	------------------------	------------------



- Standard on 2" (5 cm) receiver hitch.
- It offers 1,650 lb (750 kg) of towing capacity.
- Hitch ball not included.
- Forged steel.

# PERFORMANCE

## Smart-Lok Technology

### Smart-Lok Differential

Maverick produced after January 1, 2017  
Maverick MAX

**705402936**



- Can-Am-exclusive Smart-Lok technology constitutes a true fully lockable on-the-fly front differential with electronically controlled automatic modes.
- Choose your differential settings according to your riding need: "2x4" for rear wheel traction only, "4x4 Front Diff Lock" for a fully locked 4 wheel drive, and "4x4 Smart Mode" that offers preset, intelligent calibrations for your type of riding.
- Using multiple input sources, "Smart Mode" will instantaneously engage locking with the right load at the right moment to procure maximum traction while retaining low-speed maneuverability, allowing for optimal placement and a feeling of confidence.
- The Smart-Lok Differential Kit comes standard with the Trail Mode.
- Mud, Rock and Trail Activ modes can be added by installing an additional Smart Mode Module (sold separately) to fine-tune your riding environment.
- Requires Performance Half Shafts (2x) and Smart-Lok Installation Kit for installation.

### Performance Half Shaft

Maverick, Maverick MAX

**705401634 · 64"**

Maverick, Maverick MAX

**705402048 · 72"**



- High-performance design ideal for off-road use, with superior protection in any riding usage.
- Includes CVs, shaft and boots with the best suited geometry for your Can-Am vehicle.
- Required to install the Smart-Lok Differential Kit.

### Mud Smart Mode Module

*(Not illustrated)*

Maverick, Maverick MAX with Smart-Lok Differential  
(except Turbo RR models 2021 & up)

**715005282**

- This module allows you to add the Mud Smart Mode to vehicles with the Smart-Lok Differential Kit sold as an accessory or to change to the Mud Smart Mode on vehicles equipped with a standard Smart-Lok.
- The Mud Mode has been specially designed to deliver superior traction in the deepest mud holes.
- When high engine torque and/or slippage is detected, Smart-Lok will fully lock the front end.
- The system will stay locked until throttle release.
- Only one Smart Mode Module can be installed at a time.

### Rock Smart Mode Module

*(Not illustrated)*

Maverick, Maverick MAX with Smart-Lok Differential  
(except Turbo RR models 2021 & up)

**715005283**

- This module allows you to add the Rock Smart Mode to vehicles with the Smart-Lok Differential Kit sold as an accessory or to change to the Rock Smart Mode on vehicles equipped with a standard Smart-Lok.
- The Rock Mode has been specially designed to help cross challenging rocks.
- When high engine torque is detected at low vehicle speed, Smart-Lok will progressively lock the front end and will stay engaged until throttle release to prevent wheel slippage and provide optimal traction.
- The progressive engagement allows for easier steering when maneuvering the vehicle.
- Only one Smart Mode Module can be installed at a time.

### Trail Activ Smart Mode Module

*(Not illustrated)*

Maverick, Maverick MAX with Smart-Lok Differential  
(except Turbo RR models 2021 & up)

**715005284**

- This module allows you to add the Trail Activ Smart Mode to vehicles with the Smart-Lok Differential Kit sold as an accessory or to change to the Trail Activ Smart Mode on vehicles equipped with a standard Smart-Lok.
- The Trail Activ mode has been designed for aggressive riding, delivering the ultimate cornering precision.
- When high engine torque and/or an increase in vehicle speed is detected, Smart-Lok will progressively engage the front end and maintain it engaged until throttle release or vehicle speed reduction.
- The progressive engagement allows for smoother and lower steering effort.
- Only one Smart Mode Module can be installed at a time.

### Lonestar Racing Mud Flaps with Brackets

Maverick, Maverick MAX

**715004865**



- These bolt-on mud flaps make a great addition.
- Durable chromoly brackets.
- Protect trailing arms, rotors and CVs from rocks and debris.
- Sold in pairs.

**Lonestar Racing Heavy-Duty Shift Plate & Knob**

Maverick, Maverick MAX

**715004866**

- The shift plate is made from durable stainless steel and bolts into place for a secure fit.
- The kit comes with a billet aluminum Lonestar Racing shift knob.
- Offers improved durability for the performance-oriented driver.

**Lonestar Racing Outer Toe Link Boxed Gussets Roller Fairlead**

Maverick, Maverick MAX 2021 &amp; prior

**715004868**

- Protects and strengthens the middle radius rod links from rough riding conditions.
- Includes high-grade steel bolts.

**Lonestar Racing Quick Release Clutch Cover Pins**

Maverick, Maverick MAX

**715005045**

- This kit will allow you to take off your clutch cover in seconds to access the belt tool-lessly.
- Includes 4 stainless steel "quick release" pins with clips and tethers.
- Replaces all clutch cover screws.
- This product affects the clutch cover sealing. It is highly recommended to use this product under dry riding conditions only.

**Lonestar Racing Heavy-Duty Rear Boxed Radius Rod Support Plate**

Maverick, Maverick MAX 2021 &amp; prior

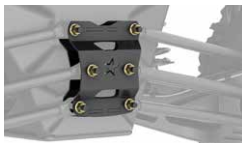
**715005046**

- Double-layered radius rod support plate made of high-grade steel.
- Reinforces your rod mounting location on the frame while adding a mean racing look to your vehicle.
- Easy to install.

**Yoshimura† Slip-on Exhaust**

Maverick, Maverick MAX

**715002882**

- Developed in collaboration with Yoshimura.
- Made from 304-grade stainless steel with brushed aluminum tip.
- Better sounding, better looking and 19% lighter than stock muffler.
- USDF/USDA approved spark arrester.
- Fuel injection system tuning not required.
- ROHVA and EPA compliant.
- Not EC compliant.

**Performance Air Filter by Twin AIR†**

Maverick, Maverick MAX

**715002895**

- The best choice for the harshest conditions.
- Multiple staged oiled filtering foam for superior dust retaining capacity with high airflow.
- Washable and reusable.

**Foam Replacement***(Not illustrated)*

Maverick, Maverick MAX

**715000713**

- Replacement foam for Performance Twin Air Filter.

**Snorkel Pre-filter**Maverick, Maverick MAX  
(with Snorkel Kit)**715005599**

- Pre-filter specifically for snorkels.
- Adds extra protection to your engine in harsh riding conditions.
- Helps keep air filter cleaner.
- Filter blocks particles larger than 0.005" (0.13 mm).
- Necessary to maintain vehicle warranty when tracks are installed.

<b>Snorkel Kit</b>	Maverick, Maverick MAX (2019 and prior)	<b>715003733</b>
	Maverick, Maverick MAX (2020 & up)	<b>715007110</b>



- Raises point of engine and CVT air intakes so vehicle can be semi-submersed in water or mud without the engine taking in water.
- Not compatible with S&B Particle Separator, LinQ Pivoting Rack, Lonestar Racing Rear Intrusion Bar or any rear panels or windows.
- Sealed Air Box 707800780 (sold separately) is required for installation on models manufactured before January 1, 2018.
- Standard on Maverick X mr models.
- Not EC-compliant.

<b>Radiator Relocator</b>	Maverick, Maverick MAX	<b>715004937</b>
---------------------------	------------------------	------------------



- Relocates stock radiator to rear of cage.
- Protects it from debris and rocks.
- Prevents cooling performance loss in muddy conditions.
- Reduces hot air in the cabin.
- Easy to clean.
- Includes support hardware and hoses.
- Not compatible with any bed accessories, Rear Cage mounted accessories, Complete MTX Audio system and Upper Soft Doors (except LinQ 8 gal [30 L] Cooler Box).
- Radiator (709200703) is required for installation on 2017 models.
- Not compatible with full windshield.

WARNING: Any modifications or addition of accessories may affect the handling of your vehicle. It is important to take the time to get familiar with the vehicle once modifications are made to understand how to adapt your driving behavior accordingly. Do not tamper with unauthorised modifications or install equipment not specifically certified by BRP for the vehicle. These modifications have not been tested by BRP and they may increase the risk of injury or loss of control, or render the vehicle illegal to ride. Ask your authorised BRP dealer for suitable available accessories for your vehicle.

<b>850 W Magneto Kit</b>	Maverick, Maverick MAX (2021 & up)	<b>715006279</b>
--------------------------	------------------------------------	------------------



- Increases the magneto output to 850 W.
- Includes rotor, stator and regulator.

<b>High Output 172 HP Upgrade Kit X3</b>	Maverick, Maverick MAX (2017 models)	<b>715004700</b>
--	--------------------------------------	------------------



- Performance upgrade kit for Maverick 2017 models only.
- Gain 18 HP for a total of 172 HP.
- Includes: intercooler with fan, fuel pump catalyst and high performance belt.
- Installation must be done by an authorised BRP dealership to preserve the vehicle's warranty.
- C.A.R.B. Executive Order #D-799U.

<b>172 HP Intercooler Upgrade Kit</b> <i>(Not illustrated)</i>	Maverick, Maverick MAX (2018 and 2019)	<b>715007137</b>
	Maverick, Maverick MAX (2020)	<b>715007277</b>

- Intercooler upgrade for the Maverick 2018 & up.
- Installation must be done by an authorised BRP dealership to preserve the vehicle's warranty.
- Requires the Power Upgrade Installation Kit (715007111).

## Emergency Accessories

<b>Lonestar Racing Fire Extinguisher Support</b>	Maverick, Maverick MAX	<b>715007320</b>
--	------------------------	------------------



- Quick-release support that lets riders slide the fire extinguisher out in a matter of seconds in an emergency.
- Made of billet anodized black aluminum.
- Fits 1.85" (4.7 cm) tubing.
- Can be fixed anywhere on the cage.
- Provides riders with the safety and security of knowing they have dependable emergency equipment on board.
- Comes with both billet mounts, quick-pull pin, mounting plate and two clamps.
- Fire extinguisher sold separately.
- "Lonestar Racing for Can-Am" branded.

<b>Fire Extinguisher</b>	<b>295100833</b>
--------------------------	------------------



- Ideal for grease, oil and electrical fires.
- Fits with Lonestar Racing Fire Extinguisher Support Kit.
- Not EC compliant.
- Not available in Europe.

WARNING: Any modifications or addition of accessories may affect the handling of your vehicle. It is important to take the time to get familiar with the vehicle once modifications are made to understand how to adapt your driving behavior accordingly. Do not tamper with unauthorised modifications or install equipment not specifically certified by BRP for the vehicle. These modifications have not been tested by BRP and they may increase the risk of injury or loss of control, or render the vehicle illegal to ride. Ask your authorised BRP dealer for suitable available accessories for your vehicle.



## Emergency Kit

Maverick, Maverick MAX

715006102



- Complete emergency kit provides all essential equipment and supplies to get out of most unfavorable situations powersport enthusiasts can find themselves in.
- Includes: jumper cables, air compressor, tire repair kit, ratchet tie-down, duct tape, 3,300 lb (1,500 kg) tow strap, zip-ties, cloth rags.

# APACHE TRACK SYSTEMS

## Winter Tracks

Limited Warranty\*

### Apache Backcountry LT Track System

Maverick, Maverick MAX

715004734



- Tracks designed to deliver the best snow performance on the market with unmatched flotation level and traction on snow surface.
- Large contact patch, 37% bigger than the Apache 360 LT.
- Impressive added ground clearance of 7" (18 cm) helps keep the vehicle over the snow.
- Lightweight snowmobile-inspired rail design.
- Aggressive track design with 2" (5 cm) lug height for maximum traction on snow.
- Apache Backcountry LT Mounting Kit, Track DPS Module and Engine and CVT Pre-Filter are required.
- Fine-tune your track system using extra Idler Wheels, Sliders with Vespel Inserts and Rail Ice Scratcher.
- For winter use only.
- Track installation will affect vehicle width and length.

### Apache Backcountry LT Mounting Kit

(Not illustrated)

Maverick, Maverick MAX

715004397 · 64" models

715004394 · 72" models

- Required for installation of the Apache Backcountry Track LT System.
- DPS Module and Pre-Filter are required and sold separately.

## Year-Round Tracks

Limited Warranty\*

### Apache 360 LT Track System

Maverick, Maverick MAX

715005103



- Multifunctional tracks designed to support heavy loads and to fit on most Can-Am off-road vehicles.
- Extra contact patch adjustment for better performance over rough terrain.
- Contact patch is 7 to 9% bigger than the Apache 360's.
- Average ground clearance of 16" (41 cm). 1" (2.5 cm) lugs in the front and 1.25" (3.2 cm) in the back.
- EC compliant.
- Apache 360 LT Mounting Kit, Track DPS Module and Engine and CVT Pre-Filter Kit are required and sold separately.
- Recommended for use on snow only.

### Apache 360 LT Mounting Kit

(Not illustrated)

Maverick, Maverick MAX

715004392 · 64" models

715004393 · 72" models

- Required for installation of the Apache 360 LT Track System.
- Track DPS Module and Pre-Filter not included.

\*The limited warranty is subject to the exclusions, limitations of liabilities and all other terms and conditions of BRP's standard limited warranty.

# APACHE TRACK SYSTEMS FITTING GUIDE

## Apache Backcountry LT

Model Year / Model	Track	Track Mount	Track DPS Module	Prefilter without Snorkel	Prefilter with Snorkel
2017 & Up Maverick, Maverick MAX (64" Models)	715004734	715004397	715007338 Maverick, Maverick Max 2022 & prior (except Turbo RR Engine) OR 715006266 Maverick, Maverick Max 2023, and 2022 & prior with Turbo RR Engines	715005600 (except X mr)	715005599
2017 & Up Maverick, Maverick MAX (72" Models)		715004394			

## Apache 360 LT

Model Year / Model	Track	Track Mount	Track DPS Module	Prefilter without Snorkel	Prefilter with Snorkel
2017 & Up Maverick, Maverick MAX (64" Models)	715005103	715004392	715007338 Maverick, Maverick Max 2022 & prior (except Turbo RR Engine) OR 715006266 Maverick, Maverick Max 2023, and 2022 & prior with Turbo RR Engines	715005600	715005599
2017 & Up Maverick, Maverick MAX (72" Models)		715004393			

\*The limited warranty is subject to the exclusions, limitations of liabilities and all other terms and conditions of BRP's standard limited warranty.

## Accessories

### Rail Ice Scratchers

Apache Backcountry LT Track System

860201728



- Provide additional lubrication in hard and icy conditions.
- Rail mounted, small, light.
- Design expands on coil concept to allow reversing without damage.
- Easily stored when not in use.
- Extends slider life.

### Apache Backcountry LT Wheel Kit

Apache Backcountry LT Track System

715006293



- Additional wheel kit for Backcountry LT rear tracks.
- Reduces drag and rolling resistance in hard snow conditions or when transporting heavier loads.
- Extends slider life in hard snow conditions.
- Includes two wheels, cross shaft and mounting hardware per kit to service one track corner.
- Up to two kits per rear track can be installed.

### Sliders with Vespel<sup>†</sup> Inserts

Apache Backcountry LT Track Systems

503194815



- Use DuPont Vespel inserts for less friction.
- Longer life.
- Can be cut to desired length.
- 8 needed per vehicle.
- Sold individually.

### Track DPS Module

(Not illustrated)

Maverick, Maverick MAX (Turbo RR Engine only)

715006266

Maverick, Maverick MAX (except Turbo RR Engine)

715007338

- Innovative DPS module that ensures speedometer accuracy and optimized steering assist, making for perfect track control and riding ease.
- Required to install the Apache Track Systems.

## Engine & CVT Air Intake Pre-Filter

Maverick, Maverick MAX (except X mr models)

715005600



- Adds extra protection to your engine in harsh riding conditions.
- Helps keep air filter cleaner.
- Filter blocks particles larger than 0.007" (0.19 mm).
- Easy installation.
- Not compatible with S&B Particle Separator.
- Necessary to maintain vehicle warranty when tracks are installed.

*Required to install the Apache Backcountry LT and Apache 360 LT Track Systems.*

# PROMOUNT PLOWS

## ProMount Plow Kits – Reference Charts

	72" Black Steel	72" Yellow Steel	72" Flex2
Plow Kit	715008176	715008177	715008175
Blade	715004474	715006021	715004485
Push Frame	715008116	715008116	715008116
Mounting Plate	715008197	715008197	715008197

## Can-Am ProMount Steel Plow Kits

### Can-Am ProMount Steel 72" (183 cm) Plow Kit

Maverick, Maverick MAX

■ 715008176 · Black  
■ 715008177 · Yellow



- These kits include:
  - Can-Am ProMount Steel Blade
  - Push Frame with Quick-Attach System
  - Can-Am ProMount Mounting Plate

## Can-Am ProMount Steel Blades

### Can-Am ProMount Steel 72" (183 cm) Blade

Fits ProMount Push Frame

■ 715004474 · Black  
■ 715006021 · Yellow



- Plow blade made from 12-gauge steel.
- Replaceable wear blade.
- Large pin designed for easy blade rotation to eliminate snow buildup at pivot point.
- Blade design provides best snow roll-off at any angle.
- Clears 66" (168 cm) when plow is fully angled.
- Blade height of 17" (43 cm).
- Compatible with Can-Am ProMount Blade accessories to further enhance plow versatility.
- Not compatible with S3 High Clearance Front A-Arm.

## Can-Am ProMount Angle Plows

### Can-Am ProMount 72" (183 cm) Steel Oneway State Blade

Fits ProMount Push Frame

715007264



- Make the job easier with the right tools, clear long alleys and make the task easier by sending the snow further out of the way.
- Wing end of plow measures 26" (67 cm) high and tapers down to 16" (41 cm).
- One-way "winged" state plow designed to throw snow higher.
- Rubber Flap (715007299) designed to keep snow away from the driver is offered as accessory (sold separately).
- Can-Am branded.

## Can-Am ProMount Flex2 Plow Kit

### Can-Am ProMount Flex2 72" (183 cm) Plow Kit

Maverick, Maverick MAX

715008175



- These kits include:
  - Can-Am ProMount Flex2 Blade
  - Push Frame with Quick-Attach System
  - Can-Am ProMount Mounting Plate

## Can-Am ProMount Flex2 Blades

### Can-Am ProMount Flex2 72" (183 cm) Blade

Fits ProMount Push Frame

715004485



- Plow blade made of UHMWPE, flexible and impact absorbing material prevents damaging your plow when accidental impact occurs.
- Replaceable wear blade.
- Large pin designed for easy blade rotation to eliminate snow buildup at pivot point.
- Blade design provides best snow roll-off at any angle.
- Clears 66" (168 cm) when plow is fully angled.
- Blade height of 17" (43 cm).
- Compatible with Can-Am ProMount Blade accessories to further enhance plow versatility.

## Can-Am ProMount Plow Accessories

### Can-Am ProMount Edge Markers

Maverick, Maverick MAX

715004206

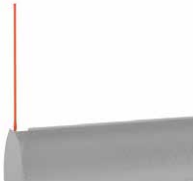

- Help locate the edges of your plow.
- Height: 24" (60 cm).
- Sold in pairs.
- Compatible with Can-Am ProMount Steel and Flex2 Blades with or without Blade Extensions (except for the Can-Am ProMount Steel 54" (137 cm) Blades).

### Can-Am ProMount 72" (183 cm) Plastic Wear Blade

Maverick, Maverick MAX

715004483



- Ideal to prevent marks on your driveway.
- Compatible with Can-Am ProMount 72" (183 cm) Blades.

### Can-Am ProMount Drift Cutters

Maverick, Maverick MAX

715006258

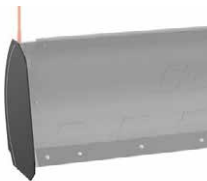

- Help keep snow in the plow.
- Dimensions: 17" x 13" (43.2 cm x 33 cm).
- Sold in pairs.
- Compatible with Can-Am ProMount Steel and Flex2 blades with or without Blade Extensions (except for the Can-Am ProMount Steel 54" (137 cm) Blades).

### Can-Am ProMount Blade Extensions

Maverick, Maverick MAX

■ 715004205 - Black  
■ 715005319 - Yellow



- These conveniently extend your Can-Am ProMount Blade.
- Add 3" (8 cm) each side.
- Compatible with Can-Am ProMount Blades (except for the Can-Am ProMount Steel 54" (137 cm) Blades).
- Longer Wear Blade can be installed to go over the extra length given by the extensions.



### Back Drag Blade

(Not illustrated)

ProMount Plows (60" and more)

715007794

- ¼ thick steel swivel scraper.
- Lifts up when the vehicle is moving forward so as not to affect the scraping.
- Increased capacity to pull snow.
- More aggressive scraping in reverse mode.
- Lifts the scraper off the ground so that it scrapes evenly.
- Adjustable in length for compatibility with 60", 66" and 72" blades.
- Compatible with ProMount blades (Flex and Steel).
- Not compatible with Backcountry Track Kit.

### Curved Wear Blade

(Not illustrated)

Maverick, Maverick MAX

715007793 · 72" (183 cm)

- Wear blade designed with a folded back bottom lip.
- The increased surface allows for less digging while plowing uneven surfaces.
- Ideal for snow covered gravel, grass, paver stone and other soft surfaces.

## Can-Am ProMount Custom Solutions

### Can-Am ProMount Push Frame with Quick-Attach System

Maverick, Maverick MAX

715008116



- Heavy-duty steel tubes designed to withstand the roughest use.
- Mid-mount carriage provides ultimate push strength and traction.
- Designed for maximum plow lift height.
- Features a self-aligning quick-attach system, an easy foot release pedal and an ergonomic handle for plow angle adjustment.
- Plow Limit Switch recommended to extend winch cable lifespan.
- Can-Am ProMount Mounting Plate required for installation.
- Blade swivels left or right, 5 positions.
- Large pin designed for easy blade rotation to eliminate dirt and snow buildup at pivot point.
- Plow Roller Fairlead included.

### Can-Am ProMount Push Frame Extension

Maverick, Maverick MAX

715006257

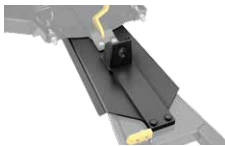

- 12" (30 cm) push frame extension required when plow is installed with Apache Track systems.

### Can-Am ProMount Mounting Plate

Maverick, Maverick MAX

715008197



- Required to install the Can-Am ProMount Push Frame with Quick-Attach System.
- Mounting plate precision designed to stay on year round without compromising ground clearance.
- Comes with the Plow Roller Fairlead.
- Not compatible with S3 High Clearance Front A-Arm.

### Can-Am ProMount Plow Angling System

Maverick, Maverick MAX

715009241



- Converts your plow system into an easy-to-control unit from the driver's seat.
- Allows you to have full up/down and left/right plow control at your fingertips with the supplied joystick.
- Using one hand to control all plow motions allows you to easily concentrate and manage your plowing tasks.
- Compatible with the SxS ProMount Push Frame and Blade.
- Not compatible with Apache Backcountry LT Track System.
- Push Frame Extension (715006257) is required for installation with the Front Rancher Bumper.
- Winch and plow sold separately.

### ProMount Plow Limit Switch

(Not illustrated)

Maverick, Maverick MAX

715006259

- For controlling the cable tension when over-raising your plow system.
- Prevents winch, plow push frame and vehicle damage.
- Sensor relocated for optimal lift height.

### Plow Roller Fairlead

Maverick, Maverick MAX

715001223  
• Cylindrical Roller Fairlead



- Larger diameter lower roller reduces wear on wire rope for plow application.
- Can be used with all ProMount plows.

# COVER & TRAILERING

## Trailer Cover

(Not illustrated)

Maverick

715005813

Maverick MAX

715005814

- Heavy-duty canvas made of UV-resistant solution-dyed polyester.
- Inner soft liner protects windshield and colored panels from abrasion.
- All high-abrasion areas are reinforced with a double canvas layer.
- Weather-resistant trailering cover protects your vehicle during storage and transportation.
- Opening for fuel cap and cabin access on passenger side.
- Quick and easy installation.
- Designed to perfectly fit your vehicle with or without Can-Am accessories.

## Bolt-On<sup>†</sup> Retractable Ratcheting Tie-Downs

295101072



- Perfect for transporting your powersport vehicle or securing loads.
- Mounts easily: bolts on any flat surface (e.g., truck bed or frame).
- 1" x 6' (2.5 cm x 1.8 m) tie-down strap with heavy-duty stitching that delivers a 500 lb (226 kg) working load strength and 1,500 lb (680 kg) break strength.
- Convenient retractable push button automatically slackens, spools and stores away strap, while the ratchet mechanism tightens the strap snugly to secure your vehicle or load into place.
- Rubber ratcheting handle provides firm grip, and the hook is vinyl coated to protect whatever surface it hooks into.
- Sold in pairs.

## Ratchet Tie-Downs

715008309 · Black/Gray



- 400 lb (181 kg) safe working load.
- 1" x 10' (2.5 cm x 3 m) strap with Sea-Doo, Ski-Doo and Can-Am logos.
- Deluxe ratchet with rubber handle.
- Coated S hooks.
- Pack of 2.

## Heavy-Duty Ratchet Tie-Down

715008308



- 1,000 lb (454 kg) safe working load.
- 1.5 in. x 6 in. (38 mm x 1.8 mm) strap with BRP brands.
- Deluxe ratchet with rubber handle.
- Black-coated clip hooks.
- 12" (300 mm) webbing included.
- Pack of two.



---

# CAN-AM MAVERICK R

---

---

# CAN-AM MAVERICK R

---

## ACCESSORIES

Roofs	94
Windshields & Wind Protection	94
Mirrors	95
Upper Wind Nets	95
HMWPE Skid Plates	96
Bumpers & Guards	96
LinQ: Easy On, Easy Off Cargo	98
Racks & Storage	102
ACM & SMART Accessories	105
Lights	106
Audio Systems	109
Electrical & Electronic Accessories	110
Winches	111
Performance	113







---

# MAVERICK R ACCESSORIES

---

# BUNDLE UP TO LEAVE YOUR MARK. YOUR MAVERICK R BUNDLES.

## STEP 1: CHOOSE YOUR ESSENTIAL BUNDLE

		Maverick R
STARTER	Aluminum Side Mirrors	715007363
	Electronic Device Holder	715007176
	LinQ Side Cargo Boxes (13.5 L)	715007372
	Upper Door Storage Bags	715008065
ADVANCED	Glass Windshield	715007181
	Cold Air Roof Scoop	715008280
	Rear Wind Screen	715007317
	XPS Screen Protector	860202680
PEAK	Intermittent Wiper & Washer Kit	715007173
	Wiper & Washer Kit Wiring Harness	715008855

## STEP 2: PICK YOUR ADD-ON BUNDLE

		Maverick R
ACM	Accessory Control Module	715009796
	Rear ACM Harness	715009268
	SMART Control Center for ACM	715007712
SMART LIGHTS	SMART Integrated LED Side Mirror Lights	715007185
	SMART Integrated LED Hood Light	715007378
	SMART Integrated LED Roof Light	715007322
	SMART LED Chase Lights	715007727
AUDIO	Can-Am JL Audio System - Level 5	715007957
	Auxiliary Battery Installation Kit	715007837
ADVENTURE	Desert Front Bumper	715007311
	LinQ Trunk Box (96L)	715007182
	Adventure Roof Rack	715007186
	LinQ Pivoting Rack	715007306

# YOU DESERVE THE BEST. THE ESSENTIAL MAVERICK R BUNDLE.

## YOU WANT IT ALL? WE'VE GOT IT ALL!

**NOTHING  
BUT  
THE BEST**

	<b>Maverick R</b>
Aluminum Side Mirrors	715007363
Electronic Device Holder	715007176
LinQ Pivoting Rack	715007306
LinQ Side Cargo Boxes (13.5 L)	715007372
LinQ Trunk Box (96 L)	715007182
Upper Door Storage Bags	715008065
Overhead Storage Bag	715007379
Shoulder Storage Bag	715007371
Glass Windshield	715007181
Cold Air Roof Scoop	715008280
Rear Wind Screen	715007317
Upper Wind Nets	715007376
XPS Screen Protector	860202680
Accessory Control Module	715009796
Rear ACM Harness	715009268
SMART Control Center for ACM	715007712
SMART Integrated LED Side Mirror Lights	715007185
SMART Integrated LED Hood Light	715007378
SMART Integrated LED Roof Light	715007322
SMART LED Chase Lights	715007727
Intermittent Wiper & Washer Kit	715007173
Can-Am JL Audio System - Level 5	715007957
Can-Am JL Audio Roof - Level 4	715007309
Auxiliary Battery Installation Kit	715007837
Rock Sliders	715007170
Desert Front Bumper	715007311
Desert Rear Bumper	715007172
HMWPE Skid Plate Kit	715007373
Front Intrusion Bar	715007312

# ROOFS

## NEW Sport Roof

Maverick R

715007364



- Impact-resistant injected polypropylene.
- Provides excellent protection from the elements and downhill visibility.
- Designed to work with the Cold Air Roof Scoop (715008280).
- Windshield compatible.

## NEW Cold Air Roof Scoop

Maverick R

715008280



- Feeds fresh air to the engine compartment.
- Sleek design for a sleek racing look.
- Increases cold air to the intake to prevent power loss.
- Required when using a full windshield.
- Requires a Sport Roof or Can-Am JL Audio Roof - Level 4.
- Not compatible with the Audio Roof Flip Kit.

# WINDSHIELDS & WIND PROTECTION

## Windshields

### NEW Glass Windshield

Maverick R

715007181



- Curved and laminated glass full windshield.
- Seals firmly against the cage and protects both the rider and the passenger from the elements.
- Provides maximum optical clarity and abrasion resistance.
- Must be used with the Wiper & Washer Kit for clear visibility during severe riding conditions, including mud riding.
- Use with rear wind protection to maximize passenger comfort.
- Must be used with the Cold Air Roof Scoop (715008280).
- Compatible with the SMART Integrated Roof LED Light.
- Not compatible with the Audio Roof Flip Kit (715008164).

### NEW Full Windshield - Hardcoated

Maverick R

715007321



- Highly impact-resistant Quantum<sup>+</sup> hardcoated polycarbonate full windshield.
- Formed polycarbonate construction for enhanced rigidity.
- Provides excellent optical clarity and better abrasion resistance.
- Protects the driver and the passenger from the elements.
- Quick and easy toolless removal.
- Use with rear wind protection to maximize comfort for the passenger.
- Can be used with the Windshield Wiper & Washer Kit (715007173) (light-duty usage only).
- Compatible with SMART Integrated Roof LED Light.
- Must be used with the Cold Air Roof Scoop (715008280).
- Not compatible with the Audio Roof Flip Kit (715008164).

### Intermittent Wiper & Washer Kit

Maverick R

715007173



- An ideal way to keep your windshield clear in the rain, or while riding through mud and water.
- The wiper mechanism and washer fluid dispenser are perfectly concealed on the vehicle.
- The wiper and washer fluid dispenser installs at the bottom of the windscreen for maximum visibility.
- For use on Glass or Hardcoated Windshields.
- Intermittent wiper speed feature available when the kit is installed in combination with ACM.
- Electric Harness required (715008855) to hook up and operate the Wiper & Washer Kits when ACM is not installed. Sold separately.

### NEW Manual Wiper Kit

Maverick R

715009424



- Single manual wiper that can be used to clear windshield of debris.
- Easy to install system that requires no electrical hookup.
- Large ergonomic handle provides a good grip over the entire sweeping surface.
- Compatible with glass and hardcoated windshields that use top mounted wipers.



## Rear Wind Protection

### NEW Rear Polycarbonate Window

Maverick R

715007315



- High impact-resistant polycarbonate window.
- Reduces windshield backdraft and stops dust and rain from entering the cabin for added comfort.
- Quick and easy installation.
- Designed to work with Can-Am's JL Audio Level - 3 and 5 rear speakers, and all roofs.

### NEW Rear Wind Screen

Maverick R

715007317

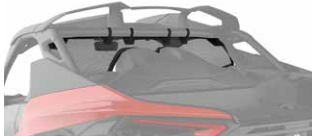

- Full rear mesh screen reduces windshield backdraft for added cabin comfort.
- Installs quickly and easily on roll cage.

## MIRRORS

### NEW Aluminum Side Mirrors

Maverick R

715007363



- Sleek design.
- High-quality black molded aluminum for extreme durability.
- The convex surface provides a wider field of view and better visibility around the unit.
- Can be installed at any height on the cage A-pillar for optimized rider vision.
- Possibility to install the Integrated LED Side Mirror Lights (715007185).
- Adjustable ball-joint mirrors.
- Possibility to fold down the mirrors (fold-away mechanism).
- Compatible with windshields and upper door net.
- Sold in pairs.

### NEW Side Mirrors

Maverick R

715007188



- Sleek design.
- High-impact resistant plastic mirrors.
- The convex surface provides a wider field of view and better visibility around the unit. Can be installed at any height on the cage A-pillar for optimized rider vision.
- Adjustable ball-joint mirrors.
- Possibility to fold down the mirrors (fold-away mechanism).
- Compatible with windshields and upper door net.
- Sold in pairs.

### Rear View Mirror and Camera Monitor

Maverick R

715009410



- Fully waterproof rearview mirror and monitor kit.
- See exactly what you need to see with the multiple camera feeds from the rear view camera.
- This unit replaces the stock rearview mirror (the screen is integrated in the unit's replacement rearview mirror).
- The camera uses infrared light for night vision capabilities.

## UPPER WIND NETS

### NEW Upper Wind Nets

Maverick R

715007376



- This complete mesh screen net with a steel frame attaches to the door of the vehicle for added protection from the wind and mud.
- Easy to use, it follows the door's movements.
- Facilitates ingress and egress.
- The net zips up and down for added ventilation when required.
- Sold in pairs.

# HMWPE SKID PLATES

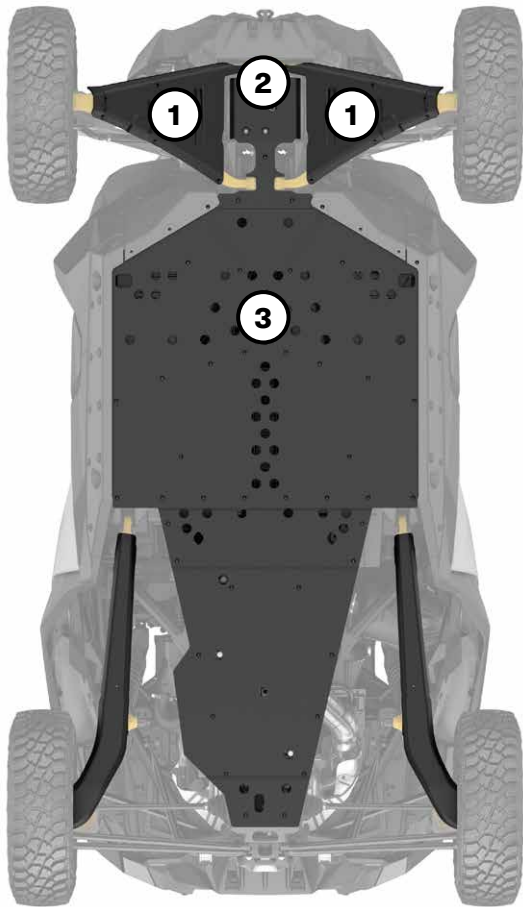

## MAVERICK R

2023

### HMWPE Skid Plate Protection Kit

715007373

#### Individual HMWPE Skid Plates

①	HMWPE Front A-Arm and Trailing Arm Protectors	715007183
②	HMWPE Front Skid Plate	715007313
③	HMWPE Underbelly Plate	715007314

Our plastic plates glide smoothly and silently over obstacles, offering great protection in rough terrain. Made of abrasion-resistant thermoformed  $\frac{3}{8}$ " (10 mm) thick High Molecular Weight Polyethylene (HMWPE).

- Lighter than aluminum.
- Superior stress crack resistance.
- High-impact strength.

# BUMPERS & GUARDS

## Bumpers

### NEW Trail Front Bumpers

Maverick R

■ 715007803 · Black  
■ 715008763 · Yellow

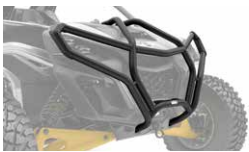

- Can-Am's largest front bumper protects the headlights and radiator area of the unit.
- Added heavy-duty protection in extreme driving conditions.
- Made of 1.5" (3.8 cm) diameter steel tubing.
- Anti-corrosion coating with durable powder coat finish.
- Combine with the Rock Sliders and Rear Bumper for ultimate protection.
- Features integrated mounting points for lights.
- Winch compatible.

### NEW Desert Front Bumpers

Maverick R

■ 715007311 · Black  
■ 715007691 · Yellow



- Sleek and rugged design.
- Provides added protection without sacrificing the agility and performance of the vehicle.
- Made of heavy-duty steel profiled tubing to protect the front of the unit.
- Inside and outside anti-corrosion coating with durable powder coat finish.
- Combine with the Rock Sliders and Rear Bumper for ultimate protection.
- Features integrated mounting points for lights.
- Winch compatible.

## NEW Dune Front Bumpers

Maverick R

■ 715007169 · Black  
■ 715007305 · Raw Metal



- Highly integrated bumper that creates a more pronounced attack angle and provides added protection to the vehicle.
- Allows for better ground clearance.
- The sleek design gives the unit a sportier look.
- Made of heavy-duty steel with a 1/8" (3 mm) aluminum plate.
- Inside and outside anti-corrosion coating with durable powder coat finish.
- Features an integrated Tow Hook.
- Not winch compatible.

## NEW Desert Rear Bumpers

Maverick R

■ 715007172 · Black  
■ 715007694 · Yellow



- Rugged design.
- Provides added protection to the rear of the unit without sacrificing the agility and performance of the vehicle.
- Gives riders extra grip on the bumper and improves accessibility to rear cargo.
- Made of heavy-duty steel profiled tubing.
- Inside and outside anti-corrosion coating with durable powder coat finish.
- Combine with the Rock Sliders and Front Bumper for ultimate protection.

## Rock Sliders

### NEW Rock Sliders

Maverick R

■ 715007170 · Black  
■ 715007693 · Yellow



- Protect the vehicle's sides against obstacles.
- With added grip on top to improve accessibility to the roof cargo.
- Made of unique heavy-duty steel profiled tubing.
- Inside and outside anti-corrosion coating with durable powder coat finish.
- Combine with the Front and Rear Bumpers for ultimate protection.
- Sold in pairs.

### NEW HMW-HDPE Rock Sliders

Maverick R

715008142



- The sleek design gives the vehicle a sportier look.
- Tight integration with the unit's body to provide maximum obstacle clearance and outstanding protection.
- Made of combination of HMWPE and HDPE for extra durability.
- Add the Dune Front Bumper for ultimate protection and integrated lights for optimal visibility.
- Sold in pairs.

## Intrusion Bar

### NEW Front Intrusion Bar

Maverick R

715007312



- The steel intrusion bar matches the vehicle's styling and enhances its visual impact.
- The tube's design doesn't obstruct the rider's line of sight, and reduces blind spots for increased visibility.
- Inside and outside anti-corrosion coating with durable powder coat finish.
- Compatible with the 40" (102 cm) Baja Designs OnX6 Arc LED Light Bar (710006818) and SMART Integrated LED Roof Light (715007322).
- Compatible with all windshields.

# LINQ: EASY ON, EASY OFF CARGO

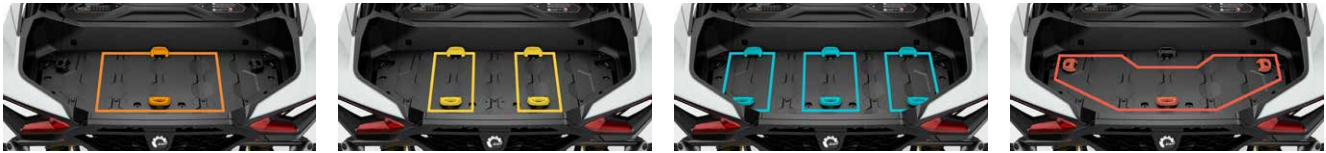

## MAVERICK R'S LINQ ACCESSORIES

### Mounting location and requirements

<ul style="list-style-type: none"> <li>• No tools needed: Quickly install and remove accessories by hand</li> <li>• Equip your Can-Am for specialized tasks in no time</li> <li>• Sturdy mounting system that holds up to the roughest terrain</li> </ul>	Standard Cargo Bed	LinQ Pivoting Rack 715007306	Adventure Roof Rack 715007186
<b>LinQ Accessories with 16" Base</b> <ul style="list-style-type: none"> <li>• LinQ anchors mounted 16 inches apart, center-to-center.</li> <li>• Lower loading capacity than the LinQ with 36" base accessories.</li> <li>• Can be used on Can-Am ATV and SxS vehicles, Can-Am Spyder and Ryker vehicles, Sea-Doo watercraft and Ski-Doo snowmobiles.</li> </ul>			
<b>LinQ 4.2 Gal Cooler</b> 295100698 • White 219400964 • Black	Central position: No further requirements (fit on stock mounted LinQ anchors)  Other positions: LinQ Base Installation Kit <b>715008125</b> (1 set needed/accessory)	LinQ Base Installation Kit <b>715008125</b> (1 set needed/accessory)	LinQ Base Installation Kit <b>715008125</b> (1 set needed/accessory)
<b>LinQ Tool Kit</b> 715006829			
<b>LinQ Tool Box</b> 715008111			
<b>LinQ SR 5.5 Gal (21 L) Bag</b> 860202449			
<b>LinQ 4.5 Gal (17 L) Sport Bag</b> 860202447			
<b>LinQ Modular Box</b> 715005494 • (10 L) 715007112 • (20 L) 715006830 • (30 L)			
<b>LinQ Roll-Top Bag</b> 715008110			
<b>LinQ Accessories with 36" Base</b> <ul style="list-style-type: none"> <li>• Mount on LinQ racks often used by Can-Am ORV vehicles.</li> <li>• Higher loading capacity than the LinQ with 16" base accessories.</li> <li>• Usage is limited to Can-Am ORV vehicles.</li> </ul>			
<b>LinQ Cargo Box (53L)</b> 715006997	No further requirements (fit on stock mounted LinQ anchors)	LinQ Base Installation Kit <b>715008125</b> (2 sets needed/accessory)	LinQ Base Installation Kit <b>715008125</b> (2 sets needed/accessory)
<b>LinQ Low Profile Box (63L)</b> 715007827			
<b>LinQ Cargo Basket (90L)</b> 715005274			
<b>LinQ 9.2 Gal (35L) Cooler</b> 715006998			
<b>LinQ Cargo Accessories</b>			
<b>LinQ Trunk Box (96L)</b> 715007182	No further requirements (fit on stock mounted LinQ anchors)	LinQ Base Installation Kit <b>715008125</b> (2 sets needed/accessory)	LinQ Base Installation Kit <b>715008125</b> (2 sets needed/accessory)
<b>LinQ Side Cargo Boxes (13.5L)</b> 715007372			
<b>LinQ Holders</b>			
<b>LinQ Gear Grips</b> 715005340	No further requirements	LinQ Base Installation Kit <b>715008125</b> (1 set needed)	Side wall installation LinQ Adapters <b>715003058</b>
<b>LinQ Tool Holder</b> 715007358			



# LinQ Accessories with 16" Base

## LinQ Modular Box

Maverick R

715005494 · (10 L)

715007112 · (20 L)

715006830 · (30 L)



- Allows stacking of other modular boxes to always have the right gear accessible.
- Always have the right box size to fit everything.
- Can be installed on any LinQ base with a 16" width.
- See table for installation location and requirements.

## Thermal Insert for LinQ Modular Box (10 L)

Maverick R

219401110



- Insulated liner.
- Fits very well in the LinQ Modular Box (10 L).
- Can contain seven 355 ml cans.
- Keeps ice cold for one day.
- Interior dimensions: 9" L x 17" W x 2½" H.

## LinQ Tool Box

Maverick R

715008111



- High precision injected HDPE construction provides rigidity and durability.
- 5 gal (19 L) maximum capacity.
- Weather-resistant, sealed and lockable cover.
- Easy one-second on/off tool-less system.
- All the benefits of LinQ—simple, fast and secure.
- See table for installation location and requirements.

## LinQ Tool Kit

Maverick R

715006829



- Includes:
  - Cutter pliers
  - Long-nose pliers
  - Locking pliers
  - Ratchet wrench ¾" drive
  - 6" ratchet extension
  - Integrated CVT belt storage location (belt not included)
  - Long-socket 19 mm ¾" drive - 6 pts
  - Socket 18 mm ¾" drive
  - Long-socket 17 mm ¾" drive - 6 pts
  - Socket 15 mm ¾" drive
  - Socket 13 mm ¾" drive
  - Socket 10 mm ¾" drive
  - Socket 8 mm ¾" drive
  - Combined wrench 19 mm
  - Combined wrench 18 mm
  - Combined wrench 15 mm
  - Combined wrench 13 mm
  - Combined wrench 10 mm
  - Combined wrench 8 mm
  - Socket Torx T40 ¾" drive
  - Socket Torx T30 ¾" drive
  - Socket Torx T20 ¾" drive
  - Breaker bar ¾" drive
- See table for installation location and requirements

## LinQ 4.2 Gal (16 L) Cooler

Maverick R

■ 219400964 · Black  
■ 295100698 · White



- All the benefits of LinQ—simple, fast and secure.
- Rotomolded construction for exceptional rigidity and durability.
- Premium-quality foam insulation for optimal ice retention.
- Uses LinQ mounting system (Patent US 8777531 and US 8875830).
- Easy one-second on/off tool-less system.
- Can contain twenty 355 ml cans.
- Keeps ice cold for three days.
- Exterior dimensions: 13" L x 20" W x 10" H.
- Interior dimensions: 9" L x 17" W x 7" H.
- See table for installation location and requirements.

## LinQ 4.5 Gal (17 L) Sport Bag

Maverick R

860202447



- 17-liter (4.5 US gallon, 1,037 cu. in.) capacity.
- Rigid bottom, semi-rigid top.
- See table for installation location and requirements.

**SR 5.5 Gal (21 L) LinQ Bag**

Maverick R

**860202449**

- All the benefits of LinQ—simple, fast and secure.
- Semi-rigid expandable bag.
- 5.5 gal (21 L) capacity.
- Utilizes LinQ mounting system (Patent US 8777531 and US 8875830).
- Easy one-second on/off tool-less system.
- See table for installation location and requirements.

**LinQ Roll-Top Bag**

Maverick R

**715008110**

- Fully waterproof roll-top dry bag will securely store and confine your equipment.
- LinQ mounted using heavy-duty rigid plastic base.
- High capacity storage solution (40 L).
- Bottom foam liner for additional equipment protection.
- Integrated handle for easy transportation on/off the vehicle.
- Dimensions: 14" L x 19" W x adjustable H.
- See table for installation location and requirements.

**LinQ Accessories with 36" Base****NEW LinQ 9.2 Gal (35 L) Cooler**

Maverick R

**715006998**

- LinQ-mounted for efficient and secure storage, locked in place with only a quarter turn.
- Easy to install, easy to remove using the LinQ system.
- Installation in LinQ 36" configuration.
- Made of polyethylene for exceptional rigidity and durability.
- Storage capacity of 35 L.
- Lock the cooler on the vehicle using the LinQ Lock (860201968).
- Premium-quality foam insulation for optimal ice retention.
- Option to add a 5-slot LinQ Lite Rail on the side and at the rear of the cooler.
- A dry basket is included to protect your food from water.
- Drain plug at the bottom to get rid of excess water.
- The new ergonomic and resistant latch system ensures the top is tightly sealed.
- Innovative way to hold 12 cans (355 ml).
- Molded-in handles for quick installation and removal.

**LinQ Cargo Box (53 L)**

Maverick R

**715006997**

- Made of polyethylene.
- Storage capacity of 14 gal (53 L).
- Easy to install and remove with the LinQ system.
- New ergonomic and resistant latch system offers excellent sealing.
- Possibility to install LinQ 16" accessories on the cover and increase the cargo capacity.
- Ability to install Tool Holders (715008896) on the box.
- Lockable with a lock on the front of the box (2 keys included).

**NEW LinQ Low Profile Box (63 L)**

Maverick R

**715007827**

- Made of impact-resistant injected polypropylene and weatherproof, this box has a storage capacity of 63 L.
- LinQ-mounted for efficient and secure storage, it is locked in place with only a quarter turn. Easy to install, easy to remove using the LinQ system.
- Can be installed in several 16" configurations, or in a 36" configuration.
- LinQ 16" accessories can be installed on the cover to increase cargo capacity.
- Easily carried with the rigid handle. The anti-vibration system prevents the handle from moving while riding.
- Support feet at hinge level so the box can stand on its own.
- The compact design allows for maximum rear field of vision.
- Features a lock on the front of the box (two keys included).

**LinQ Cargo Basket (90 L)**

Maverick R

**715005274**

- Made of polyethylene.
- Storage capacity of 23 gal (90 L).
- Easy to install and remove with the LinQ system.
- Can already be installed on your vehicle thanks to the stock mounted LinQ anchor.
- 6 handles on the contour to easily install bungee cords.
- Ability to install Tool Holders (715008896) on the basket.

## LinQ Cargo Accessories

### NEW LinQ Trunk Box (96 L)

Maverick R

715007182



- Weatherproof box made of impact-resistant injected polypropylene reinforced with glass fiber.
- Features a maximum storage capacity of 96 L and 15 kg.
- Easy to install, easy to remove with the LinQ system.
- Can already be installed on your vehicle thanks to the stock mounted LinQ anchor.
- Ability to install in conjunction with the LinQ Side Cargo Boxes (13.5 L) for a complete cargo solution.
- Compatible with the Pivoting Rack.

### NEW LinQ Side Cargo Boxes (13.5 L)

Maverick R

715007372



- Weatherproof box made of impact-resistant injected polypropylene reinforced with glass fiber.
- Features a maximum storage capacity of 13.5 L each and 5 kg.
- Easy to install, easy to remove thanks to the LinQ system.
- Possibility of installing up to two LinQ 16" accessories between the LinQ Side Cargo Boxes (13.5 L).
- Ability to install in conjunction with the LinQ Trunk Box (96 L) for a complete cargo solution.
- Compatible with the Pivoting Rack.

## LinQ Holders

### LinQ Tool Holder

Maverick R

715007358



- Ultra-versatile tool holder.
- Convenient swivel-latch allows tools to be stored in any orientation.
- Sold in pairs.

### LinQ Gear Grips

Maverick R

715005340



- Durable and flexible grips provide a custom fit for a variety of items from 1" to 4" (2.5 cm to 10 cm) in diameter.
- Heavy-duty design for carrying bows, fishing poles, rakes, farm tools and more.
- Quick-release button opens grip quickly for easy access to gear.
- Heavy-duty base system built for the toughest adventures.
- Make transporting your tools a snap by combining the LinQ Gear Grips with the LinQ system.
- 360° orientation.
- Sold in pairs.

## LinQ Mounting

### LinQ Adaptor

Maverick R

715003058



- Sold in pack of 4.
- Allows the installation of the LinQ Tool Holder on the Adventure Roof Rack.

### LinQ Base Installation Kit

Maverick R

715008125



- Unique mounting fastener usable on any LinQ system accessory.
- Included: 2 Cargo LinQ bases and hardware.

### LinQ Lock

Maverick R

860201968



- Simple way to securely lock most LinQ accessories.
- Lock cover protects lock from the elements.
- Corrosion resistant.
- Pack of 1, includes 2 keys.
- Not compatible with LinQ 4.2 US Gal (16 L) Cooler, LinQ Tool Box, LinQ Tool Holder or LinQ Gear Grips.

## Spare Tire Ratchet Tie-Downs

Maverick R

280000955



- 3-way ratcheting tie-down strap with loop ends.
- Designed to securely hold spare tires on accessories equipped with integrated spare tire attachment points.
- Adjustable to accommodate most common UTV tire sizes.
- Ratchet and junction ring made of durable zinc-plated steel.
- Required for spare tire attachment on Adventure Roof Rack.

# RACKS & STORAGE

## Racks

### NEW LinQ Pivoting Rack

Maverick R

715007306



- Strong and durable, the LinQ Pivoting Rack helps keep cargo securely in place.
- Anti-corrosion coating with durable powder coat finish.
- Gaz cylinder pivot action, locks in the open position.
- Possibility of installing up to three LinQ 16" accessories on top of the rack.
- Compatible with LinQ accessories for installation under the rack.
- Features anchor points for the spare-tire attachment.
- Spare Tire Tie-Downs sold separately.

### NEW Adventure Roof Rack

Maverick R

715007186



- The ideal cargo solution. Pack all the gear you need to take on any off-road experience.
- Built using lightweight 1.25" (3.2 cm) diameter steel tubing.
- Supports loads of up to 75 lb (34 kg).
- This roof rack features a height adjustment setting to precisely accommodate a stock roof or a roof with Cold Air Roof Scoop.
- Integrated mounting points for lights.
- Features anchor points for a spare tire attachment.
- Can be completed with LinQ Adaptor (715003058) on the side.
- The Spare Tire Tie-Downs sold separately.
- Sport roof is required for installation.

## Storage

### NEW Shoulder Storage Bag

Maverick R

715007371



- This weather-resistant bag holds your gear safely and securely while you ride.
- Attach the bag between the seats to maximize unused space and increase the vehicle's cargo capacity.
- This bag has a 1.5 gal (6 L) capacity and is equipped with outer netting compartments and a flexible inner net to hold items in place.
- The thermoformed base attaches to the doors, allowing the bags to be installed.
- Its soft construction makes the bag flexible enough to fit odd-shaped loads.

### NEW Overhead Storage Bag

Maverick R

715007379



- This weather-resistant bag holds your gear safely and securely while you ride.
- Makes smart use of the overhead space and increases the vehicle's cargo capacity by 2.3 gal (9 L).
- The thermoformed base attaches to the roof for easy bag installation and the soft construction makes the bag flexible enough to fit oddly shaped loads.
- Features a hanging function for easier access to the items in the bag and an integrated net for even more storage space.
- Contains two sections: a fixed bag and a detachable bag that can be carried.
- Easily access your smartphone using the touchscreen-compatible clear front pocket.

### NEW Upper Door Storage Bags

Maverick R

715008065



- These weather-resistant bags hold your gear safely and securely while you ride.
- The Door Bags fit in the upper door opening to increase your vehicle's cargo space.
- Each bag is designed as a 1.3 gal (5 L) capacity pocket and is equipped with inner netting compartments.
- The thermoformed base attaches to the doors, allowing the bags to be installed.
- Its soft construction makes the bag flexible enough to fit odd-shaped loads.
- Added elbow cushions for extra comfort.
- Sold in pairs.



**NEW Lower Door Storage Bags**

Maverick R

**715007324**

- These weather-resistant bags hold your gear safely and securely while you ride.
- The Door Bags fit in the lower door opening to increase the vehicle's cargo space.
- Each bag is designed as a 1.3 gal (5 L) capacity pocket and equipped with inner netting compartments.
- The thermoformed base attaches to the doors, allowing the bags to be installed.
- Its soft construction makes the bag flexible enough to fit odd-shaped loads.
- Added cushions for extra comfort.
- Sold in pairs.
- Not compatible with Door Speakers (Level 5 Audio System).

**NEW Passenger Storage Seat Bag**

Maverick R

**715008080**

- This weather-resistant bag holds your gear safely and securely while you ride.
- Bag settling on the passenger seat to increase the vehicle's cargo capacity.
- This bag features a 14.5 gal (55 L) storage capacity and is divided into two compartments.
- The top compartment is insulated to keep your beverages cold and includes two cup holders.
- Additional pocket inside for additional storage, such as a cell phone.
- The bottom compartment is accessible from both sides and serves as a large pocket for storing various items.
- The detachable pocket at the front of the bag can be used as a garbage bag.

**NEW Back Panel Storage Net**

Maverick R

**715008312**

- Storage net behind the passenger seat for more storage.

**NEW Bed Side Doors**

Maverick R

**715009154**

- Creates a storage solution out of the rear bed cavities of the unit.
- Perfect for housing trail and safety items that remain on the vehicle.
- Includes two Bed Side Doors, one for each side.

# INTELLIGENCE MEETS ACCESSORIES

Maximize your riding experience with live ECU information from your vehicle.

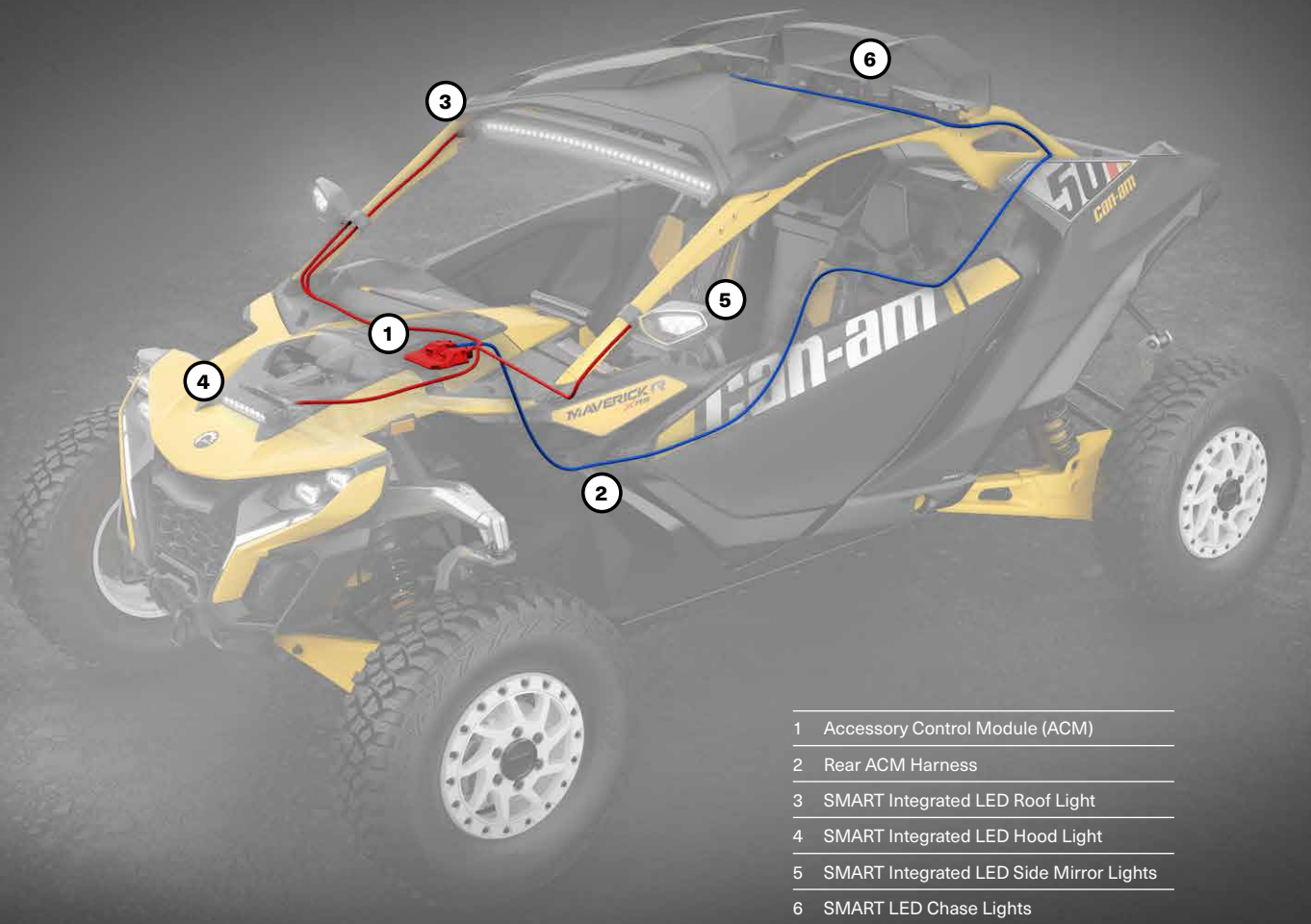

## Can-Am SMART Accessories are an industry first!

Driven by the Can-Am ACM (Accessory Control Module), the SMART accessories react to sensors in the vehicle. For example, lights change from Flood to Spot when you speed, and follow a curve's direction based on steering input.

# ACM & SMART ACCESSORIES

## Accessory Control Module (ACM)

### NEW Accessory Control Module

Maverick R

715009796



- Bringing the SMART to accessories using live vehicle ECU information to maximize your accessory experience.
- Connect your accessories to the 10.25" Color Touchscreen Display.
- Easy accessory installation (plug and play).
- Creates an ecosystem that makes installing accessories quicker and easier.
- Includes ACM Front Harness to connect front-mounted SMART accessories to the Accessory Control Module (two auxiliary connectors available).
- Requires ACM Rear Harness (715009268) to connect rear-mounted SMART accessories to the Accessory Control Module.

### NEW Rear ACM Harness

(Not Illustrated)

Maverick R

715009268

- Required to connect rear-mounted accessories and rear chase lights to the ACM.
- Creates an ecosystem that makes installing accessories quicker and easier.
- Five auxiliary connectors are available.

### NEW SMART Control Center for ACM

Maverick R

715007712



- Control the accessories with the selection of different modes, the illuminated halo around the button indicates the active mode.
- Icons illuminate when accessories are activated.
- Make accessory control changes without having to take your eyes off the trail by choosing the accessory button required (quick access).
- All Front LED Off button to turn off all front lights with one click. Remembers the last programmed setups when this button is pressed again.
- 6 pre-programmed buttons (Light Bars, PowerFlip Windshield, All Front LED Off, Corner Lights) and 8 programmable buttons to customize according to the accessories installed.

## SMART Accessories

### NEW SMART Integrated LED Roof Light

Maverick R

715007322

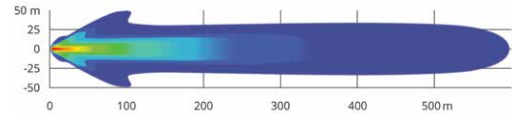

- Mounted under the roof for a signature look.
- Windshield compatible.
- Intensity varies (increases or decreases) according to the speed of the vehicle with the installation of the Accessory Control Module (ACM) (Spot/Flood ratio).
- Spot/Flood combo beam.
- 22,100 lumens.
- Off/Low/High (switch activated).
- Off/Low/High/SMART Automatic Mode (Accessory Control Module (ACM) activated).
- Accessory Control Module (715009796) is required for SMART functionality.
- Electric Harness (715008209) required to hook up and operate the Integrated LED Roof Light (715007322) for on/off function when ACM is not installed. Sold separately.

### NEW SMART Integrated LED Hood Light

Maverick R

715007378

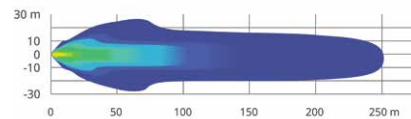

- Mounted flush inside the hood scoop for a signature look.
- Intensity varies (increases or decreases) according to the speed of the vehicle with the installation of the Accessory Control Module (ACM) (Spot/Flood ratio).
- Spot/Flood combo beam.
- 5,250 lumens.
- Off/Low/High (switch activated).
- Off/Low/High/SMART Automatic Mode (Accessory Control Module (ACM) activated).
- Accessory Control Module (715009796) is required for SMART functionality.
- Wiring harness required for on/off function when ACM is not installed. Sold separately.

**NEW SMART Integrated LED Side Mirror Lights**

Maverick R

**715007185**

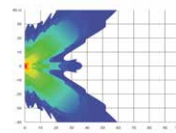

- Light up corners.
- Increase the width of the beams and illuminate the wheels for increased visibility.
- Wide flood beam.
- 3,000 lumens for each light.
- Left & right dynamic lighting with Accessory Control Module (ACM) install. Follow steering wheel input.
- Accessory Control Module (715009796) is required for SMART functionality.
- Wiring harness required for on/off function when ACM is not installed. Sold separately.
- Require Aluminum Side Mirrors (715007363).
- Electric Harness required (715008212) to hook up and operate the Integrated LED Side Mirror Lights for on/off function when ACM is not installed.

**NEW SMART LED Chase Lights**

Maverick R

**715007727**



- Designed by Can-Am to make you visible to vehicles riding behind you, especially in dusty or harsh conditions.
- Four modes available:
  - Trail Mode: serves as a tail light and as a brake light.
  - Chasing Mode: displays amber light pattern and serves as a brake light.
  - Work Mode: white light to light up your cargo bed.
  - Reverse Mode (when connected with Accessory Control Module (ACM)): serves as a back up light.
- Modular to allow installation with rear roll cage mounted accessories.
- Plug-and-play installation with the Accessory Control Module (ACM).
- Accessory Control Module (715009796) and Rear ACM Harness (715009268) are required for SMART functionality.
- Electric Harness (715008210) required to hook up and operate the LED Chase Lights (715007727) for a non-smart function when ACM is not installed.

**Intermittent Wiper & Washer Kit**

Maverick R

**715007173**



- An ideal way to keep your windshield clear in the rain, or while riding through mud and water.
- The wiper mechanism and washer fluid dispenser are perfectly concealed on the vehicle.
- The wiper and washer fluid dispenser installs at the bottom of the windshield for maximum visibility.
- For use on Glass or Hardcoated Windshields.
- Intermittent wiper speed feature available when the kit is installed in combination with ACM.
- Electric Harness (715008855) required to hook up and operate the Wiper & Washer Kit (715007173) for on/off function when ACM is not installed.

# LIGHTS

## SMART Lights

		<b>SMART LIGHTS WHEN ACM IS INSTALLED</b>			
<b>SMART functionality</b>		SMART Integrated LED Roof Light <b>715007322</b>	SMART Integrated LED Hood Light <b>715007378</b>	SMART Integrated LED Side Mirror Lights <b>715007185</b>	SMART LED Chase Lights <b>715007727</b>
		Accessory Control Module (ACM) with Front ACM Harness <b>715009796</b>		Aluminum Side Mirrors <b>715007363</b> + Accessory Control Module (ACM) with Front ACM Harness <b>715009796</b>	Accessory Control Module (ACM) <b>715009796</b> + Rear ACM Harness <b>715009268</b>
		<b>SMART LIGHTS WHEN ACM IS NOT INSTALLED</b>			
<b>ON/OFF functionality</b>		SMART Integrated LED Roof Light <b>715007322</b>	SMART Integrated LED Hood Light <b>715007378</b>	SMART Integrated LED Side Mirror Lights <b>715007185</b>	SMART LED Chase Lights <b>715007727</b>
		Wiring Harness <b>715008209</b>	Wiring Harness <b>715008211</b>	Aluminum Side Mirrors <b>715007363</b> + Wiring Harness <b>715008212</b>	Wiring Harness <b>715008210</b>

\*All lights are intended for off-road use only.



# BAJA Lights

		2 Choose your lights				
1 Choose your mount point		BAJA LIGHTS WHEN ACM IS INSTALLED				
		40" (102 Cm) Baja Designs OnX6 Arc LED Light Bar 710006818	10" (25 Cm) Baja Designs OnX6 LED Light Bar 710006819	Baja Designs XL Sport LED Lights 710006821	Baja Designs Squadron Sport LED Lights 710004648	Baja Designs XL80 LED Lights 710005041
<b>Desert Front Bumper</b> (715007311 or 715007691)	N/A	LED Light Bars ACM Adaptor 715008213		LED Lights ACM Adaptor 715007715	LED Lights ACM Adaptor 715007715	LED Lights ACM Adaptor 715007715
<b>Trail Front Bumper</b> (715007803 or 715008763)	N/A	N/A				
<b>Roof with Light Support Bar</b> (715003529)	N/A	N/A				
<b>Roof Light Mounting Kit</b> - Low Position (715008585)	LED Light Bars ACM Adaptor 715008213	N/A	N/A	N/A	N/A	N/A
<b>Roof Light Mounting Kit</b> - High Position (715007930)		N/A	N/A	N/A	N/A	
		2 Choose your lights				
1 Choose your mount point		BAJA LIGHTS WHEN ACM IS NOT INSTALLED				
		40" (102 Cm) Baja Designs OnX6 Arc LED Light Bar 710006818	10" (25 Cm) Baja Designs OnX6 LED Light Bar 710006819	Baja Designs XL Sport LED Lights 710006821	Baja Designs Squadron Sport LED Lights 710004648	Baja Designs XL80 LED Lights 710005041
<b>Desert Front Bumper</b> (715007311 or 715007691)	N/A	Wiring Harness 715008863		Wiring Harness 715008865	Wiring Harness 715008865	Wiring Harness 715008865
<b>Trail Front Bumper</b> (715007803 or 715008763)	N/A	N/A				
<b>Roof with Light Support Bar</b> (715003529)	N/A	Wiring Harness 715008863				
<b>Roof Light Mounting Kit</b> - Low Position (715008585)	Wiring Harness 715008864	N/A	N/A	N/A	N/A	N/A
<b>Roof Light Mounting Kit</b> - High Position (715007930)		N/A	N/A	N/A	N/A	
<b>3 Order</b>		<b>Order all part numbers in intersecting box</b> <i>*Note: When installing more than one light kit, additional light power cable or mounting kit is required.</i>				

\*All lights are intended for off-road use only.

**40" (102 cm) Baja Designs OnX6 Arc LED Light Bar** | Maverick R | **710006818**



29,000 lumens

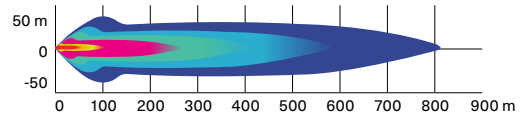

- 252 W light bar producing 29,000 lumens.
- Equipped with 24 Cree XM-L2 LEDs.
- Driving/Combo light pattern for smooth blend of light for both near field applications and distance.
- Designed for installation onto Light Support Bar equipped roofs.
- Requires Light Power Cable and Light Support Bar.
- ACM Adaptor required (715008213) to connect the Baja Designs LED Light Bars to the ACM harness.
- Electric Harness (715008864) required to hook up and operate the 40" (102 cm) Baja Designs OnX6 Arc LED Light Bar (710006818) for on/off function when ACM is not installed.
- Baja Designs Light Mounting Kit (715007930 or 715008585) is required for installation.
- See table for installation location and requirements.

**Baja Designs 10" (25 cm) OnX6 LED Light Bar** | Maverick R | **710006819**



12,460 lumens

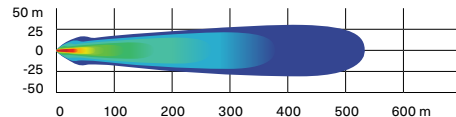

- 108 W light bar producing 12,460 lumens.
- Equipped with 6 Cree XM-L2 LEDs.
- Driving/Combo light pattern for smooth blend of light for both near field applications and distance.
- Dual intensity (high/low) settings.
- Requires Baja Designs Light Power Cable.
- ACM Adaptor required (715008213) to connect the Baja Designs LED Light Bars to the ACM harness.
- Electric Harness (715008863) required to hook up and operate the 10" (25 cm) Baja Designs OnX6 LED Light Bar (710006819) for on/off function when ACM is not installed.
- See table for installation location and requirements.

**Baja Designs XL80 LED Lights**

Maverick R

**710005041**

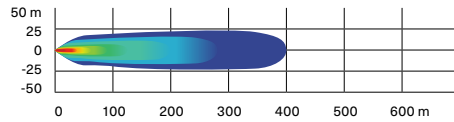

- 80 W per spot producing 9,500 lumens.
- Equipped with 4 Cree XHP50 LEDs per spot.
- Dual intensity (high/low) settings.
- Driving/combo light pattern for smooth blend of light for both near field applications and distance.
- Require Baja Designs Light Power Cable.
- Sold in pairs.

- Dimensions: 4.5" x 4.5" (11.4 cm x 11.4 cm).
- ACM Adaptor required (715007715) to connect the Baja Designs LED Lights to the ACM harness.
- Electric Harness (715008863) required to hook up and operate the Baja Designs XL80 LED Lights (710005041) for on/off function when ACM is not installed.
- See table for installation location and requirements.

**Baja Designs Squadron Sport LED Lights**

Maverick R

**710006820**

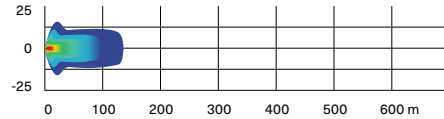

- 26 W per spot producing 3,150 lumens.
- Equipped with 4 Cree XP-G2 LEDs per spot.
- Wide cornering light pattern designed specifically for cornering, dust and/or fog conditions.
- Sold in pairs.

- Dimensions: 3" x 3" (7.6 cm x 7.6 cm).
- Electric Harness (715008865) required to hook up and operate the Baja Designs Squadron Sport LED Lights (710006820) for on/off function when ACM is not installed.
- See table for installation location and requirements.

**Baja Designs XL Sport LED Lights**

Maverick R

**710006821**

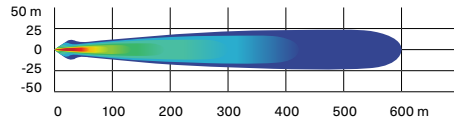

- 26 W per spot producing 3,150 lumens.
- Equipped with 4 Cree XP-G2 LEDs per spot.
- High Speed Spot features a longer and narrower beam focus for illumination farther down.
- Require Baja Designs Light Power Cable.
- Sold in pairs.

- Dimensions: 4.5" x 4.5" (11.4 cm x 11.4 cm).
- ACM Adaptor required (715007715) to connect the Baja Designs LED Lights to the ACM harness.
- Electric Harness (715008865) required to hook up and operate the Baja Designs XL Sport LED Lights (710006821) for on/off function when ACM is not installed.
- See table for installation location and requirements.

**NEW Baja Designs Light Mounting Kit - High Position**

Maverick R

**715007930**



- Mounting system for 40" (102 cm) Baja Designs OnX6 Arc LED Light Bar.
- Compatible with the Cold Air Roof Scoop.

**NEW Baja Designs Light Mounting Kit - Low Position**

Maverick R

**715008585**



- Mounting system for 40" (102 cm) Baja Designs OnX6 Arc LED Light Bar.
- Not compatible with the Cold Air Roof Scoop.



# AMPLIFYING THE MAVERICK EXPERIENCE WITH JL AUDIO

## AUDIO SYSTEMS

### NEW Can-Am JL Audio System - Level 5

Maverick R

715007957



- Orchestrated for outstanding sound quality and calibrated to enhance your audio experience.
- Designed to fit the vehicle perfectly for a fully integrated look.
- Designed to be Can-Am tough in the most demanding riding conditions.
- Controlled by the 10.25" Color Touchscreen Display or by the Can-Am JL Audio Source Unit.
- Made using premium JL Audio components, including six 6.5" (165 mm) speakers (two dash, two door, and two surround speakers), as well as two 10" (254 mm) under-seat 250 W subwoofers that will enhance both the driver's and the passenger's experience.
- Uses one MX500/4 to power up our six speakers, and one MX500/1 to feed the under-seat subwoofers.
- Complements the Can-Am Audio Roof - Level 4 (715007309).

### NEW Can-Am JL Audio Roof - Level 4

Maverick R

715007309



- Full roof with premium JL Audio System for Maverick R.
- Features fully sealed and waterproof components and construction.
- Easy to install and connect.
- Controlled by the 10.25" Color Touchscreen Display or by the Can-Am JL Audio Source Unit.
- Its weatherproof components include four 7.7" coaxial speakers and a 500-watt amplifier.
- The system is expertly tuned for exceptional sound when you're riding in your Maverick R.
- Speakers include an adjustable RGB LED cone illumination, controlled via an app on your smartphone.
- Specific to your type of riding.
- When combined with the Can-Am Audio System - Level 3 (715007954) or Level 5 (715007957), it provides the ultimate sound experience.
- Not compatible with the Adventure Roof Rack (715007186) or the Cold Air Roof Scoop (715008280).

### NEW Can-Am JL Audio System - Level 3

Maverick R

715007954



- Orchestrated for outstanding sound quality and calibrated to enhance your audio experience.
- Designed to fit the vehicle perfectly for a fully integrated look.
- Designed to be Can-Am tough in the most demanding riding conditions.
- Controlled by the 10.25" Color Touchscreen Display or by the Can-Am JL Audio Source Unit.
- Made using premium JL Audio components, including four 6.5" (165 mm) speakers (two dash and two surround speakers), and a 10" (254 mm) under-seat 250 W subwoofer that will enhance both the driver's and the passenger's experience.
- Uses one MX280/4 to power up our four speakers, and one MX500/1 to power up the under-seat subwoofer.
- Easy to install, with the option to add a second subwoofer (715007310).
- Complements the Can-Am Audio Roof - Level 4 (715007309).

**NEW Can-Am JL Audio Roof Flip Kit**

Maverick R

**715008164**

- Combines with the Can-Am JL Audio Roof - Level 4 (715007309) for Flip option.
- Not compatible with the Cold Air Roof Scoop and the Roof Rack.

**NEW Can-Am JL Audio Subwoofer**

Maverick R

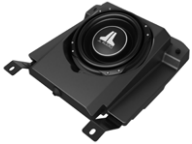
**715007310**

- Orchestrated for outstanding sound quality and calibrated to enhance your audio experience.
- Designed to be Can-Am tough in the most demanding riding conditions.
- Easy to install, this 10" (254 mm) under-seat 250 W subwoofer enhances both the driver's and the passenger's experience.
- When combined with the Can-Am audio system - Level 3 (715007954) or with the Can-Am audio roof - Level 4 (715007309), this premium JL Audio component creates the ultimate sound experience.
- To add a subwoofer to the Can-Am JL Audio Roof - Level 4, a Can-Am JL Audio Amplifier (715007714) is required.

**NEW Can-Am JL Audio Amplifier**

Maverick R

**715007714**

- Orchestrated for outstanding sound quality and calibrated to enhance your audio experience.
- Designed to fit the vehicle perfectly for a seamless integration.
- Designed to be Can-Am tough in the most demanding riding conditions.
- This MX500/1 is a premium JL Audio component, and is used to feed one or two 250 W under-seat subwoofers.
- When combined with the Can-Am Audio Roof - Level 4 (715007309), it creates the ultimate sound experience.
- To add a subwoofer to the Can-Am JL Audio Roof - Level 4, this item is required.
- Easy to install, mounting support included.

**NEW Can-Am JL Audio Source Unit**

Maverick R

**715008230**

- Required with all Can-Am Audio JL levels installed on vehicles without 10.25" Color Touchscreen Display.
- Designed to fit the vehicle perfectly for a fully integrated look.
- AM/FM/Bluetooth compatible.

# ELECTRICAL & ELECTRONIC ACCESSORIES

**NEW Electronic Device Holder**

Maverick R

**715007176**

- Increases the storage capacity of the glovebox by 1 gal (4 L), with secure magnetic adjustable support for your electronic device.
- Robust injected fiber-reinforced-polypropylene construction allows for the right fit and easy installation.
- Magnet 10 times stronger than any electronic device's weight, ride through rough terrain confidently.
- 2 possible positions for your electronic device: Portrait & Landscape. Adjustable support with 2 positions: facing the passenger or towards the pilot for an improved driving experience and immersion.
- Includes everything needed for installation on your favorite electronic devices: 2 pre-assembled Can-Am plates with 3M multi-surface adhesive.

**NEW Cellphone Holder**

Maverick R

**715008786**

- Water resistant door allows for perfect phone positioning.
- Features capacitive and resistive touch screen technology.
- Spring system in back plate automatically adjusts for thickness.
- Fits all cellphones within 7.2" (185 mm) x 3.3" (85 mm) x 0.6" (15 mm) dimensions.
- Works with almost all charger wires.
- Does not include cellphone or charging wires.
- Requires the Electronic Device Holder (715007176) for the Cellphone Holder to be supported.

**Color Touchscreen Display Protector**

Vehicle equipped with 10.25 in. Color Touchscreen Display

**860202680**

- Provides additional protection for the digital display 10.25 in. touchscreen.
- Protects from scratches caused by ice, rocks, branches or other small debris.
- Anti-glare treatment to ensure good visibility.
- Includes cleaning tools: wet wipe, dry wipe, dust absorber and soft cloth.

**NEW Auxiliary Battery Installation Kit**

Maverick R

**715007837**

- Allows the rider to add a second battery and/or replace the original battery (18 Ah or 30 Ah) for a dual battery setup. Recommended to power auxiliary electrical components such as sound systems or winches.
- Automatic rundown protection.
- Installs behind the seat for easy access.
- Requires the purchase of a second battery and battery hardware (not included and sold separately).
- Equipped with an electronic module that prevents the auxiliary electrical components from draining the original battery.

# WINCHES

**Can-Am HD Winches****Can-Am HD 4500 Winch**

Maverick R

**715006416**

- Ergonomic clutch handle.
- Rugged all-steel gears and bushings for more torque and durability.
- Automatic 100% load-holding brake.
- Sealed solenoid for all-weather protection.
- Weather sealed corded remote and dash mounted switch.
- EC compliant.
- Pulling strength capability of 4,500 lb (2,041 kg).
- 43' of 1/8" (13.1 m of 6.3 mm) wire steel cable.
- Heavy-duty 4-way roller fairlead.
- Winch Electrical Harness (715008850), Winch Roller Fairlead Spacer (715008922) and winch compatible front bumper are required.

**Can-Am HD 4500-S Winch**

Maverick R

**715006417**

- Ergonomic clutch handle.
- Rugged all-steel gears and bushings for more torque and durability.
- Automatic 100% load-holding brake.
- Sealed solenoid for all-weather protection.
- Weather-sealed corded remote and dash mounted switch.
- Pulling strength capability of 4,500 lb (2,041 kg).
- 50' of 1/4" (15.2 m of 6.35 mm) synthetic rope.
- Corrosion-proof aluminum hawse fairlead.
- Winch Electrical Harness (715008850) and winch compatible front bumper are required.

**WARN<sup>†</sup> VRX Winches****WARN VRX 45 Winch**

Maverick R

**715006110**

- Extreme IP68-rated waterproof sealing keeps the elements out.
- Durable all-metal construction.
- Black powder-coated finish and stainless steel fasteners for corrosion resistance.
- Robust new clutch design based on 70+ years of WARN 4 WD hub lock know-how.
- Load-holding brake for great control.
- Smooth and reliable all-metal three-stage planetary gear train.
- Dash-mounted rocker control.
- Limited lifetime warranty (mechanical), 3-year warranty (electrical).
- Pulling strength capability of 4,500 lb (2,041 kg).
- 50' of 1/4" (15 m of 6.3 mm) wire steel cable.
- Roller fairlead.
- Winch Electrical Harness (715008850), Winch Roller Fairlead Spacer (715008922) and winch compatible front bumper are required.

**WARN VRX 45-S Winch**









Maverick R

**715006111**

- Extreme IP68-rated waterproof sealing keeps the elements out.
- Durable all-metal construction.
- Black powder-coated finish and stainless steel fasteners for corrosion resistance.
- Robust new clutch design based on 70+ years of WARN 4 WD hub lock know-how.
- Load-holding brake for great control.
- Smooth and reliable all-metal three-stage planetary gear train.
- Dash-mounted rocker control.
- Limited lifetime warranty (mechanical), 3-year warranty (electrical).
- Pulling strength capability of 4,500 lb (2,041 kg).
- 50' of 1/4" (15 m of 6.3 mm) synthetic rope.
- Cast aluminum hawse fairlead.
- Winch Electrical Harness (715008850) and winch compatible front bumper are required.



## Winch Accessories

<b>Can-Am HD Hawse Fairlead</b>	Can-Am HD Winch	<b>715006426</b>
	<ul style="list-style-type: none"> <li>• A must when upgrading your winch with a synthetic cable, this corrosion-proof aluminum hawse fairlead will prevent the cable from snapping in a corner of a roller fairlead and from wearing prematurely due to the rough surface of the worn roller guide.</li> <li>• Must be used with synthetic cables only.</li> </ul>	
<b>WARN Hawse Fairlead</b>	WARN Winch	<b>715007785</b>
	<ul style="list-style-type: none"> <li>• Double-powder-coated construction.</li> <li>• Required to use the Synthetic Winch Cable (715001118) on WARN winches.</li> <li>• To be used with synthetic winch cables only.</li> </ul>	
<b>NEW Winch Roller Fairlead Spacer</b>	Maverick R	<b>715008922</b>
	<ul style="list-style-type: none"> <li>• Required when using a Winch and Roller Fairlead with a wire cable.</li> <li>• Made of aluminum, with an anti-corrosion finish.</li> </ul>	
<b>Synthetic Winch Cable</b>	Can-Am HD Winch WARN Winch	<b>715006430</b> <b>715007783</b>
	<ul style="list-style-type: none"> <li>• 50' of ¼" (15.2 m of 6.35 mm) synthetic cable for Can-Am HD winches.</li> <li>• Can-Am HD Hawse Fairlead (715006426) is required when upgrading to a synthetic cable to avoid premature cable damage and wear.</li> <li>• WARN Hawse Fairlead (715007785) is required when upgrading to a synthetic cable to avoid damage and premature wear of the cable.</li> </ul>	
<b>Wire Rope Replacement</b>	Can-Am HD Winch WARN Winch	<b>705014978</b> <b>715006699</b>
	<ul style="list-style-type: none"> <li>• 43' of ¼" (14.3 m of 6.3 mm) wire rope for Can-Am HD Winch.</li> <li>• 55' of ¼" (16.8 m of 6.35 mm) wire rope for WARN winch kit.</li> <li>• 4,500 lb (2,041 kg) pulling strength.</li> </ul>	
<b>Synthetic Cable Extension</b>	<b>715001120</b>	
	<ul style="list-style-type: none"> <li>• Lightweight ¼" (6.35 mm) diameter, easy to handle and won't rattle in cargo box.</li> <li>• Easily attaches to winch cable to provide additional 50' (15.2 m) of distance.</li> <li>• 4,500 lb (2,041 kg) single line capacity.</li> </ul>	
<b>Winch Electrical Harness</b> <i>(Not illustrated)</i>	Maverick R	<b>715008850</b>
<ul style="list-style-type: none"> <li>• Required for winch installation.</li> </ul>		
<b>Wired Remote Control</b>	Can-Am HD Winch†	<b>715006504</b>
	<ul style="list-style-type: none"> <li>• This kit allows winch owners to add the hand-held remote to vehicles with a stock winch.</li> <li>• OEM stock winch is sold separately.</li> <li>• EC compliant.</li> </ul> <p>† Harness (710001023) is required to use remote control on a vehicle with a factory installed winch. ‡ Remote Control (710007050) and connection socket are included.</p>	
<b>Wireless Remote Control</b>	WARN Winch	<b>715002542</b>
	<ul style="list-style-type: none"> <li>• The system is quick and easy to install, thanks to a wiring harness with an integrated antenna and all necessary mounting hardware.</li> <li>• The system allows you to operate your winch from anywhere within a 50' (15.2 m) radius, increasing your recovery options.</li> <li>• All components are weatherproof.</li> </ul>	

# PERFORMANCE

## NEW Lonestar Racing Fire Extinguisher Support

Maverick R

715007320



- Quick-release support that lets riders slide the fire extinguisher out in a matter of seconds in an emergency.
- Made of billet anodized black aluminum.
- Fits 1.85" (4.7 cm) tubing.
- Can be fixed anywhere on the cage.
- Provides riders with the safety and security of knowing they have dependable emergency equipment on board.
- Comes with both billet mounts, quick-pull pin, mounting plate and two clamps.
- Fire extinguisher sold separately.
- "Lonestar Racing for Can-Am" branded.

## Performance Air Filter by Twin AIR†

Maverick R

715002895



- The best choice for the harshest conditions.
- Multiple staged oiled filtering foam for superior dust retaining capacity with high airflow.
- Washable and reusable.

## Digitally Encoded Security System (D.E.S.S.) Green Key

Maverick R

710005232



- Top-security anti-theft protection for your vehicle.
- Encrypted chip technology restricts access to your vehicle's electronic ignition system.
- One vehicle/one code.
- A vibration/shock-resistant ball-and-socket design that ensures a reliable connection.
- 3 programmable modes:
  - Work mode: Limits vehicle speed to 40 kph (25 mph) but does not limit engine torque.
  - Normal mode: Limits vehicle speed to 70 kph (44 mph) and 50% torque reduction.
  - Performance mode: No restrictions.









---

**CAN-AM COMMANDER,  
MAVERICK TRAIL &  
MAVERICK SPORT**

---



# CAN-AM COMMANDER, MAVERICK TRAIL & MAVERICK SPORT

## ACCESSORIES

Roofs	120
Soft Cab Enclosure	120
Windshields & Wind Protection	121
Mirrors	123
Doors	124
Seat Accessories	125
Commander Skid Plates	126
Maverick Trail & Maverick Sport Skid Plates	127
Bumpers & Guards	128
LinQ: Easy On, Easy Off Cargo	131
Cargo & Storage	136
Racks & Holders	138
Lights	141
Audio & Communication Systems	145
Electrical & Electronic Accessories	146
Winches & Hitches	148
Performance	150
Apache Track Systems	152
ProMount Plows	155
Covers	158





---

# COMMANDER, MAVERICK TRAIL & MAVERICK SPORT ACCESSORIES

---



# BUNDLE UP TO DO IT ALL. YOUR COMMANDER BUNDLES.

## STEP 1: CHOOSE YOUR ESSENTIAL BUNDLE

		Commander	Commander MAX
<b>STARTER</b>	Full Windshield – Hardcoated	715003656	715003656
	Sport Roof	715007271	715007272
	Rear Polycarbonate Window	715006113	715006113
	Side Mirror	715003639	715003639
<b>ADVANCED</b>	LinQ Cargo Rack	715006815	715006815
	Integrated Tailgate Extension	715008190	715008190
	LinQ Tool Kit	715006829	715006829
	Shoulder Storage Bag	715005019	715005019
	Electronic Device Holder	715005212	715005212
<b>PEAK</b>	LinQ Tool Holder	715007358	715007358
	Rear View Mirror and Camera Monitor	715009410	715009410
	LinQ Modular Box (10L)	715005494	715005494

## STEP 2: PICK YOUR ADD-ON BUNDLE

		Commander	Commander MAX
<b>AUDIO</b>	Complete Wet Sounds Audio System	715003672	715003672
	Can-Am Subwoofer	715006359	715006359
<b>HUNT</b>	LinQ Gun Case	715004968	715004968
	3.5" (9 cm) LED Flood Lights (2 x 14 W)	715003665	715003665
	LinQ Modular Box (20 L)	715007112	715007112
	LinQ Base Installation Kit	715008125	715008125
<b>WORK</b>	Headache Rack	715006823	715006823
	LinQ Tool & Gun Holder	715005466	715005466
	LinQ Adapter	715003058	715003058
<b>WINTER</b>	Upper Soft Door Panels – Front	715004718	715004718
	Upper Soft Door Panels – Rear	–	715004726
	Defrost, Heat and Ventilation System	715003678	715003678
	Seat Heater	715006112	715006112
	Heated Accessories Wiring Harness	710005757	710005757

# BUNDLE UP TO RULE THE OFF-ROAD. YOUR MAVERICK TRAIL / SPORT BUNDLES.

## STEP 1: CHOOSE YOUR ESSENTIAL BUNDLE

		Maverick Trail	Maverick Sport	Maverick Sport MAX
<b>STARTER</b>	Full Windshield – Hardcoated	715003656	715003656	715003656
	Sport Roof	715007271	715007271	715007272
	Rear Polycarbonate Window	715006113	715006113	715006113
	Side Mirrors	715003639	715003639	715003639
	Front Trail Bumper	715003680	715003680	715003680
<b>ADVANCED</b>	Front Corner Protectors	715004912	715004912	715004912
	Fender Flare Extensions	715004462	715004462	715004462
	Shoulder Storage Bag	715005019	715005019	715005019
	Electronic Device Holder	715005212	715005212	715005212
<b>PEAK</b>	LinQ Pivoting Rack	715008297	715008297	715008297
	Rear View Mirror and Camera Monitor	715009410	715009410	715009410
	LinQ 12 Gal (45 L) Cargo Box	715003879	715003879	715003879

## STEP 2: PICK YOUR ADD-ON BUNDLE

		Maverick Trail	Maverick Sport	Maverick Sport MAX
<b>AUDIO</b>	Complete Wet Sounds Audio System	715003672	715003672	715003672
	Can-Am Subwoofer	715006359	715006359	715006359
<b>LIGHT</b>	15" Double Stacked LED Light Bar (90 W)	715002934	715002934	715002934
	Light Power Cable	715003670	715003670	715003670
	Overhead Switch Panel	715003669	715003669	715003669
	LED Headlights Assembly	715003667	715003667	715003667
<b>CABIN</b>	Overhead Storage Bags	715005018	715005018	715005018
	Door Knee Pads with Storage	715003635	715004914	715004914
	LinQ Passenger Seat Base Kit	715003951	715003951	715003951
	Removable Central Storage Bag	N/A	N/A	715004794

# ROOFS

<b>Sport Roof</b>	Commander, Maverick Trail, Maverick Sport	<b>715007271</b>
	Commander MAX, Maverick Sport MAX	<b>715007272</b>



- Excellent protection from the elements.
- Allows installation of lights on top of the roof.
- Compatible with all windshields.

<b>ProVent Roof Module Kit</b>	Commander, Maverick Trail, Maverick Sport	<b>715005279</b>
--------------------------------	---	------------------



- Provides fresh air in the cab area.
- Optimal performance with full cab enclosure.
- 4 vents provide infinite adjustment of air flow for driver and passenger.
- Filter and pre-filter to limit dust intrusion.
- Easy cleaning of filter and pre-filter.
- Patent pending water management system to keep water out of cabin while maintaining air flow.
- Outer plug closes air intake completely for winter or heavy weather.
- Requires ProVent Roof Module Adapter Kit for Sport Roof.
- Not compatible with roof mounted LED bars, roof racks, roof liners, Bimini Roof, DragonFire Roof and Lonestar Racing Roof.

<b>ProVent Roof Module Adapter Kit for Sport Roof</b> <i>(Not illustrated)</i>	Commander, Maverick Trail, Maverick Sport	<b>715005213</b>
---	---	------------------

- Adapter for fitting ProVent Roof Module Kit onto Commander, Maverick Sport or Maverick Trail Sport Roof.
- Includes roof adapter and hardware.
- Requires ProVent Roof Module Kit (715005279).

<b>Bimini† Roof with Sun Visor</b>	Commander, Maverick Trail, Maverick Sport†	<b>715003661</b>
	Commander MAX, Maverick Sport MAX	<b>715004792</b>



- Heavy-duty canvas made of UV-resistant solution-dyed polyester.
- Soft top comes with a hard visor that allows for storage of rolled-up soft top and mounting auxiliary lights.

†Not compatible with Glass Windshield with wiper.

<b>Lonestar Racing† Aluminum Roof</b>	Commander, Maverick Trail, Maverick Sport†	■ <b>715005137</b> - Black
---------------------------------------	--	----------------------------



- Race-true low profile look with integrated front visor for eye-popping performance and protection.
- 0.083" (2.1 mm) thick aluminum roof for durable and lightweight protection from the elements.
- Not compatible with Full Windshields, Rigid Rear Window, Can-Am Intrusion Bars and Overhead Switch Panel.

# SOFT CAB ENCLOSURE

<b>Soft Cab Enclosure</b>	Maverick Trail	<b>715003618</b>
---------------------------	----------------	------------------



- Includes:
- Sport Roof
  - Full Windshield – Hardcoated
  - Upper Soft Door Panels
  - Soft Rear Panel
  - Door Seal Kit
  - Requires Half Doors on 800 Base and 800 DPS models and on all T-category models
  - Not compatible with Sport Half Doors

*Installation of some accessories shown may impact vehicle compliance with some regulations. Consult your local dealer for information.*

<b>Soft Cab Enclosure</b>	Commander, Maverick Trail, Maverick Sport (except X mr models)	<b>715004724</b>
---------------------------	---	------------------



- Can be installed on the Maverick Trail equipped with the Sport Half Doors or on Maverick Sport models.
- Includes:
- Sport Roof
  - Full Windshield – Hardcoated
  - Upper Soft Door Panels
  - Soft Rear Panel
  - Sport Half Doors required on T-category models.

*Installation of some accessories shown may impact vehicle compliance with some regulations. Consult your local dealer for information.*



**Soft Cab Enclosure**Commander MAX, Maverick Sport MAX  
(except X mr models)**715004725**

- Includes:
- Sport Roof
  - Full Windshield – Hardcoated
  - Upper Soft Door Panels
  - Soft Rear Panel
  - Sport Half Doors required on T-category models.

*Installation of some accessories shown may impact vehicle compliance with some regulations. Consult your local dealer for information.***Semi-Rigid Cab Enclosure  
(Not illustrated)**Commander,  
Maverick Trail, Maverick Sport  
(Except X mr models)**619400119**

- Can be installed on the Maverick Trail equipped with the Sport half doors or on Maverick Sport models.
- Sport Half Doors required for T-category models.

- Sport roof
- Glass Windshield with Wiper
- Overhead Switch Panel
- Upper Soft Door Panels
- Rear Polycarbonate Window

*Installation of some accessories shown may impact vehicle compliance with some regulations. Consult your local dealer for information.*

# WINDSHIELDS & WIND PROTECTION

## Windshields

**Glass Windshield**Commander, Commander MAX,  
Maverick Trail, Maverick Sport,  
Maverick Sport MAX**715003653**

- Curved and laminated glass full windshield in metal frame.
- Provides excellent optical clarity.
- Seals firmly against the cage and protects rider and passenger from the elements.
- Must be used with rear wind protection.

*Installation of some accessories shown may impact vehicle compliance with some regulations. Consult your local dealer for information.***Glass Windshield with Wiper**Commander, Commander MAX,  
Maverick Trail, Maverick Sport,  
Maverick Sport MAX**715003652**

- Curved and laminated glass full windshield in metal frame.
- Provides excellent optical clarity.
- Seals firmly against the cage and protects rider and passenger from the elements.
- Single-speed wiper with washer fluid dispenser.
- Requires the Overhead Switch Panel (715003669) for installation.
- Must be used with rear wind protection.
- Not EC compliant.

*Installation of some accessories shown may impact vehicle compliance with some regulations. Consult your local dealer for information.***Half Windshield**Commander, Commander MAX,  
Maverick Trail, Maverick Sport,  
Maverick Sport MAX
 **715003657** · Clear  
 **715005280** · Tinted

- Formed polycarbonate construction for enhanced rigidity.
- Formulated to be non-yellowing, non-crazing, non-cracking with excellent UV resistance and optical clarity.
- Protects driver and passenger from the elements.
- Features reverse angle lip to deflect air flow.
- Quick and easy tool-less installation or removal.

*Installation of some accessories shown may impact vehicle compliance with some regulations. Consult your local dealer for information.***Full Windshield**Commander, Commander MAX,  
Maverick Trail, Maverick Sport,  
Maverick Sport MAX**715003655**

- High-impact-resistant durable polycarbonate full windshield.
- Formed polycarbonate construction for enhanced rigidity.
- Formulated to be non-yellowing, non-crazing, non-cracking with excellent UV resistance and optical clarity.
- Seals firmly against the cage and protects rider and passenger from the elements.
- Must be used with rear wind protection.
- Quick and easy tool-less installation or removal.

*Installation of some accessories shown may impact vehicle compliance with some regulations. Consult your local dealer for information.*

<b>Full Windshield – Hardcoated</b>	Commander, Commander MAX, Maverick Trail, Maverick Sport, Maverick Sport MAX	<b>715003656</b>
-------------------------------------	--	------------------



- High-impact-resistant Quantum<sup>1</sup> hardcoated polycarbonate full windshield.
- Formed polycarbonate construction for enhanced rigidity.
- Provides excellent optical clarity and better abrasion resistance.
- Seals firmly against the cage and protects rider and passenger from the elements.
- Must be used with rear wind protection.
- Quick and easy tool-less installation or removal.

*Installation of some accessories shown may impact vehicle compliance with some regulations. Consult your local dealer for information.*

<b>ProVent Windshield</b>	Commander, Commander MAX, Maverick Trail, Maverick Sport, Maverick Sport MAX	<b>715005210</b>
---------------------------	--	------------------



- High-impact-resistant Quantum<sup>1</sup> hardcoated polycarbonate full windshield.
- Controllable vents to manage air flow.
- Channels air into the cabin, defogs windshield, fully closes to eliminate air flow.
- One upper vent and one lower vent with pre-filters.
- Must be used with rear wind protection.
- Provides excellent optical clarity and better abrasion resistance.
- Protects driver and passenger from the elements.
- Quick and easy tool-less installation or removal.
- Not compatible with wiper kits and Wet Sounds Stealth 6 Ultra HD Can-Am Edition Sound Bar.
- Not compatible with the Defrost, Heat and Ventilation System.

*Installation of some accessories shown may impact vehicle compliance with some regulations. Consult your local dealer for information.*

<b>PowerFlip Windshield</b>	Commander, Commander MAX, Maverick Trail, Maverick Sport, Maverick Sport MAX	<b>715003658</b>
-----------------------------	--	------------------



- The PowerFlip Windshield is equipped with electric cylinders that allow the rider to adjust the windshield opening at the touch of a button.
- Windshield is made of hardcoated polycarbonate with a rubber seal contour and a tinted top section.
- Allows you to quickly adapt to changing conditions by adjusting the windshield as you go.
- Can be fully opened for optimal visibility and ventilation, fully closed for maximum protection from the elements, and in between, you have an infinite number of openings.
- Must be used with rear wind protection.

*Installation of some accessories shown may impact vehicle compliance with some regulations. Consult your local dealer for information.*

<b>Windshield Wiper and Washer Kit</b>	Commander, Commander MAX, Maverick Trail, Maverick Sport, Maverick Sport MAX	<b>715003654</b>
--	--	------------------



- An ideal way to keep your windshield clear in rain, or while riding through mud and water.
- Includes single-speed wiper, washer fluid dispenser and windshield frame mount.
- Must be used with the Glass Windshield (715003653).
- Requires Overhead Switch Panel (715003669) for installation.
- Not EC compliant.
- Not compatible with ABS equipped vehicles.

*Installation of some accessories shown may impact vehicle compliance with some regulations. Consult your local dealer for information.*

<b>NEW Manual Wiper Kit</b>	Commander, Commander MAX, Maverick Trail, Maverick Sport, Maverick Sport MAX	<b>715009423</b>
-----------------------------	---	------------------



- Single manual wiper that can be used to clear windshield of debris.
- Easy to install system that requires no electrical hookup.
- Large ergonomic handle provides a good grip over the entire sweeping surface.
- Compatible with glass and hardcoated windshields that use top mounted wipers.

*Installation of some accessories shown may impact vehicle compliance with some regulations. Consult your local dealer for information.*

## Wind Protection

<b>Side Wind Deflectors</b>	Commander, Commander MAX, Maverick Trail, Maverick Sport, Maverick Sport MAX	<b>715008632</b>
-----------------------------	--	------------------



- Clear polycarbonate air deflectors mount on each side of the cage.
- Can be adjusted at three different positions for cabin air flow control when full windshield is installed:
  - 1) Outside deflection to reduce cabin air flow and turbulence.
  - 2) Inside deflection to increase air flow in the cabin.
  - 3) Windshield ventilation to reduce fog.
- Compatible with all windshields.
- Not compatible with full doors.
- Sold in pairs.

<b>Rear Polycarbonate Window</b>	Commander, Commander MAX, Maverick Trail, Maverick Sport, Maverick Sport MAX (except X mr models)	<b>715006113</b>
	<ul style="list-style-type: none"> <li>• High-impact-resistant polycarbonate window.</li> <li>• Blocks windshield backdraft or dust and rain from entering for added cabin comfort.</li> <li>• Sport Roof is required for installation.</li> <li>• Not compatible with Bimini Roof with Sun Visor, DragonFire Aluminum Roof and Lonestar Racing Aluminum Roof.</li> </ul>	

<b>Rear Wind Screen</b>	Commander, Commander MAX, Maverick Trail, Maverick Sport, Maverick Sport MAX (except X mr models)	<b>715003664</b>
	<ul style="list-style-type: none"> <li>• Full rear mesh screen reduces windshield backdraft for added cabin comfort.</li> <li>• Installs quickly and easily on roll cage.</li> <li>• Large Can-Am branding.</li> </ul>	

<b>Soft Rear Panel</b>	Commander, Commander MAX, Maverick Trail, Maverick Sport, Maverick Sport MAX (except X mr models)	<b>715005887</b>
	<ul style="list-style-type: none"> <li>• Plastic reinforced and weather-resistant rear panel offers good protection from the elements.</li> <li>• Made of heavy-duty UV-resistant solution-dyed polyester canvas for excellent resistance to tear and abrasion.</li> <li>• Clear window made of laminated polished vinyl material.</li> <li>• Resists cold cracking.</li> <li>• Installs quickly and easily on roll cage.</li> </ul>	

# MIRRORS

<b>Side Mirrors</b>	Commander, Commander MAX, Maverick Trail, Maverick Sport, Maverick Sport MAX	<b>715003639</b>
	<ul style="list-style-type: none"> <li>• Rugged black nylon % construction with coated cast-aluminum mount.</li> <li>• Dual adjustment (horizontal and vertical) will suit any rider.</li> <li>• Convex optics deliver optimal field of view (FOV).</li> <li>• Spring-loaded pivots let mirrors fold back completely.</li> <li>• Sold in pairs.</li> </ul> <p><i>Installation of some accessories shown may impact vehicle compliance with some regulations. Consult your local dealer for information.</i></p>	

<b>Panoramic Center Mirror</b>	Commander, Commander MAX, Maverick Trail, Maverick Sport, Maverick Sport MAX	<b>715003638</b>
	<ul style="list-style-type: none"> <li>• Wide-angle convex mirror.</li> <li>• Offers enhanced visibility.</li> <li>• Can be used with or without roof or windshield and with cab enclosure.</li> </ul>	

<b>Sport Panoramic Center Mirror</b>	Commander, Commander MAX, Maverick Trail, Maverick Sport, Maverick Sport MAX	<b>715004924</b>
	<ul style="list-style-type: none"> <li>• Convex mirror for wide rearward visibility.</li> <li>• Ball-joint design with tightening knob for steady multi-angle adjustment.</li> <li>• Can be used with or without roof or windshield.</li> <li>• Not for road use.</li> </ul>	

<b>Rear View Mirror and Camera Monitor</b>	Commander, Commander MAX, Maverick Trail, Maverick Sport, Maverick Sport MAX	<b>715009410</b>
	<ul style="list-style-type: none"> <li>• Fully waterproof rearview mirror and monitor kit.</li> <li>• See exactly what you need to see with the multiple camera feeds from the rear view camera.</li> <li>• This unit replaces the stock rearview mirror (the screen is integrated in the unit's replacement rearview mirror).</li> <li>• The camera uses infrared light for night vision capabilities.</li> </ul>	

# DOORS

## Trail Half Doors

Maverick Trail

715004418



- Half doors made of molded polypropylene to match vehicle's styling.
- Steel frame for high level of rigidity.
- A must-have for additional cabin comfort.
- Keep the vehicle narrow in tight trail riding conditions.
- Door Trim is required to complete your door kit (sold separately).
- Standard on 1000 Base and 1000 DPS models (except T-category models)\*.
- Sold in pairs.

*Installation of some accessories shown may impact vehicle compliance with some regulations. Consult your local dealer for information.*

## Door Trim

Maverick Trail

- Can-Am Red
- Timeless Black
- Octane Blue

Left	
<b>705012419</b>	
<b>705015607</b>	
<b>705016447</b>	

Right	
<b>705012420</b>	
<b>705015613</b>	
<b>705016449</b>	



- Matching colored panel for Trail Half Doors.
- Required to complete the Trail Half Doors (sold separately).

## Sport Half Doors

Commander, Commander MAX, Maverick Trail, Maverick Sport, Maverick Sport MAX

715006217



- Half doors made of molded polypropylene to match vehicle's styling.
- A must-have for additional cabin comfort.
- Features rounded shape to increase cabin space.
- Standard on all Commander & Maverick Sport models (except T-category models).
- Can be installed on Maverick Trail models for additional cabin space.
- Door Trim is required to complete your door kit (sold separately).
- Sold in pairs.

*Installation of some accessories shown may impact vehicle compliance with some regulations. Consult your local dealer for information.*

## Door Trim

Commander, Commander MAX, Maverick Trail, Maverick Sport, Maverick Sport MAX

- Can-Am Red
- Timeless Black
- Octane Blue

Left	
<b>705015464</b>	
<b>705015608</b>	
<b>705016448</b>	

Right	
<b>705015465</b>	
<b>705015615</b>	
<b>705016450</b>	



- Matching colored panel for the Sport Half Doors.
- Required to complete the Sport Half Doors (sold separately).
- Sold in pairs.

## Upper Soft Door Panels

Commander, Commander MAX, Maverick Trail, Maverick Sport, Maverick Sport MAX  
Commander MAX, Maverick Sport MAX

**715004718** - Front  
**715004726** - Rear



- Upper canvas portion of the doors with sturdy steel frame.
- Seals firmly against the cage and protects rider and passenger from the elements.
- Converts half door into full door for a complete cab enclosure.
- Zippered window made of laminated polished vinyl material for added ventilation.
- Easy to remove on hot and sunny days.
- Sport Roof required for installation.

*\*Not compatible with Trail Half Doors or with the standard half doors on Maverick Trail models.*

*Installation of some accessories shown may impact vehicle compliance with some regulations. Consult your local dealer for information.*

## Upper Soft Door Panels

(Not illustrated)

Maverick Trail

715003620

- Can only be installed with Trail Half Doors or with the standard half doors on Maverick Trail models.
- Not compatible with Sport Half Doors or with the standard half doors on Maverick Sport models.
- Sport Roof required for installation.

*Installation of some accessories shown may impact vehicle compliance with some regulations. Consult your local dealer for information.*



### Door Seal Kit

(Not illustrated)

Maverick Trail

715004773

- Improves door sealing from the elements and provides additional cabin comfort.
- Included in the Soft Cab Enclosure Kit (715003618).
- Not compatible with Sport Half Doors.
- Compatible with the Trail Half Doors or with the stock doors on the Maverick Trail.

### Door Knee Pads with Storage

Maverick Trail

715003635



- Padded door cushion with integrated pocket for storage.
- Protect driver and passenger legs from direct contact with the doors while riding.
- Increase cabin comfort.
- Require Trail Half Door on 800 Base and 800 DPS models (715004418).
- Offer storage space for small items.
- Sold in pairs.
- Not compatible with Sport Half Doors.

### Door Storage with Padding

Commander, Commander MAX,  
Maverick Trail, Maverick Sport,  
Maverick Sport MAX

715004914



- Weather-resistant door storage bags with integrated padding.
- Holds your gear safely and securely and also protects driver and passenger legs from direct contact with the doors while riding.
- Each bag is designed as a 0.5 gal (2 L) capacity pocket also equipped with inner netting compartments.
- Semi-rigid construction renders them flexible enough to fit odd-shaped loads.
- Easy to install.
- Sold in pairs.
- Bags attach on stock doors of the Maverick Sport or on the Maverick Trail equipped with the Sport Half Doors (715006217).
- Not compatible with stock doors on the Maverick Trail or the Trail Half Doors.

## SEAT ACCESSORIES

### 4-Point Harness

Commander, Commander MAX,  
Maverick Trail, Maverick Sport,  
Maverick Sport MAX

715008035 · Driver

715008036 · Passenger



- Exclusive controlled decelerator technology (patent pending) absorbs additional energy in case of accident.
- Designed to offer maximum riding comfort.
- Easy one-click latch and release.
- Not EC compliant.
- ROHVA compliant.
- Requires 4-point harness bar, ROHVA compliant when used in conjunction with Can-Am harness bars.

### 4-Point Harness Bar

Commander MAX, Maverick Sport MAX

715004847



- 1.5" (3.8 cm) diameter, thick-walled steel tubing.
- Designed for use with Can-Am 4-Point Harness.
- Not EC compliant.

### Seat Belt Shoulder Pads

Commander, Commander MAX,  
Maverick Trail, Maverick Sport,  
Maverick Sport MAX

715002894



- Provide additional riding comfort by preventing seat belt from rubbing on neck and shoulder.
- Fit with stock 3-point seat belts and 4 point harness.
- Easy Velcro installation.
- Can-Am branded.
- Sold in pairs for driver and passenger.

# COMMANDER SKID PLATES

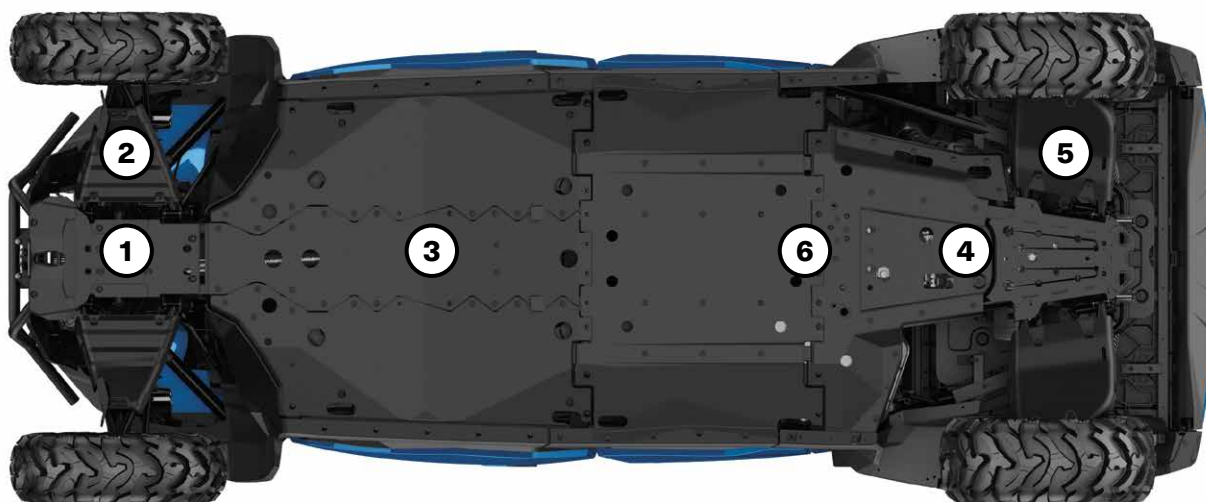

**Our plastic plates glide smoothly and silently over obstacles, offering great protection in rough terrain.**

- Made of abrasion-resistant thermoformed High Molecular Weight Polyethylene (HMWPE).
- Lighter than aluminum.

- High impact strength.
- Ultra-sturdy 3/8" (10 mm) thickness.

## COMMANDER, COMMANDER MAX

Offer your Commander the full protection kit or get parts individually

DPS & XT 700

XT 1000, XT-P & X mr

### HMWPE Skid Plate Protection Kit

Includes:

- HMWPE Front Skid Plate.
- HMWPE Front A-Arm Protectors.
- HMWPE Rear Skid Plate.
- HMWPE Rear A-Arm Protectors.
- HMWPE Underbelly Plates.
- HMWPE Central Skid Plate.

**715006349**  
(except MAX)

**715006350**  
(except MAX)

**715006351**  
(MAX only)

**715007303**  
(MAX only)

### Individual HMWPE Skid Plates

	DPS & XT 700	XT 1000, XT-P & X mr
① <b>HMWPE Front Skid Plate</b>	<b>715008279</b>	<b>715008279</b>
② <b>HMWPE Front A-Arm Protectors</b>	<b>715008276</b>	<b>715008277</b>
③ <b>HMWPE Underbelly Plates</b> Keeps the rollover clearance.	<b>715006273</b>	<b>715006273</b>
④ <b>HMWPE Rear Skid Plate</b>	<b>715007302</b>	<b>715007302</b>
⑤ <b>HMWPE Rear A-Arm Protectors</b>	<b>715004271</b>	<b>715006341</b>
⑥ <b>HMWPE Central Skid Plate</b> Provides center protection for MAX models.	<b>715004272</b> (MAX only)	<b>715004272</b> (MAX only)

# MAVERICK TRAIL & MAVERICK SPORT SKID PLATES

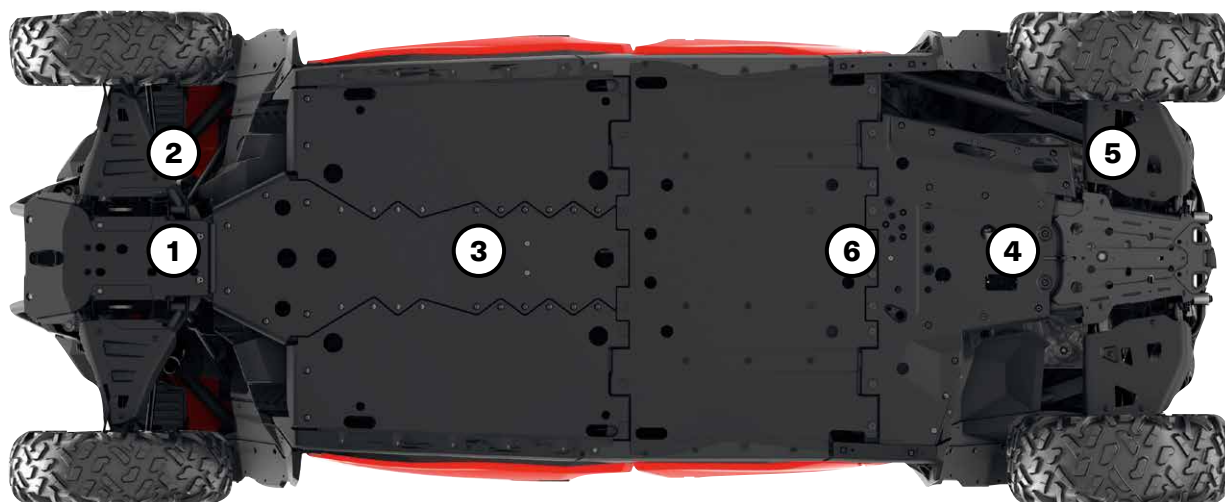

**Our plastic plates glide smoothly and silently over obstacles, offering great protection in rough terrain.**

- Made of abrasion-resistant thermoformed High Molecular Weight Polyethylene (HMWPE).
- Lighter than aluminum.

- Superior stress crack resistance.
- High impact strength.
- Ultra-sturdy 3/8" (10 mm) thickness.

## MAVERICK SPORT & MAVERICK SPORT MAX MAVERICK TRAIL

Offer your Maverick the full protection kit or get parts individually	2019 Base & DPS	2019 X mr	2020 & Up Base & DPS	2020 & Up X mr & X xc	Any Year X rc	
<b>HMWPE Skid Plate Protection Kit</b>						
Includes: - HMWPE Front Skid Plate. - HMWPE Front A-Arm Protectors. - HMWPE Rear Skid Plate. - HMWPE Rear A-Arm Protectors. - HMWPE Underbelly Plates. - HMWPE Central Skid Plate.	715006348 (except MAX)	715006353	715006349 (except MAX)	715006350	—	715006346 (2019 & prior)
	715006352 (MAX only)		715006351 (MAX only)			715006347 (2020 & up)
<b>Individual HMWPE Skid Plates</b>						
① HMWPE Front Skid Plate	715008279	715008279	715008279	715008279	(Standard on X rc models)	715008279
② HMWPE Front A-Arm Protectors	715008276	715008277	715008276	715008277	(Standard on X rc models)	715008278
③ HMWPE Underbelly Plates Keeps the rollover clearance.	715006339	715006339	715006273	715006273	715006339 (2019)	715006339 (2019 & prior)
					715006273 (2020 & up)	715006273 (2020 & up)
④ HMWPE Rear Skid Plate	715007302	715007302	715007302	715007302	715007302	715007302
⑤ HMWPE Rear A-Arm Protectors	715004271	715006341	715004271	715006341	(Standard on X rc models)	715003699
⑥ HMWPE Central Skid Plate Provides center protection for MAX models.	715004272 (MAX only)	—	715004272 (MAX only)	—	—	—

# BUMPERS & GUARDS

## Commander Bumpers

### X mr Front Bumper

Commander, Commander MAX

715007248 · Black



- Heavy-duty 1.5" (3.8 cm) diameter steel-tube construction.
- Inside and outside anti-corrosion coating with durable finish.
- Provides additional front body protection.
- Integrated winch support plate for winch relocation at a higher position for easier access in muddy conditions or for auxiliary lights.
- Allows the installation of front corner protectors.
- Winch not included.

### Front Bumper

Commander, Commander MAX

715007631



- Made of 1.5" (3.8 cm) diameter steel tubing with durable powder-coat finish.
- Includes integrated mount points for seamless light installation.
- Compatible with synthetic and steel rope winches and hawse fairlead.
- Not EC compliant.

### Front Corner Protectors

Commander, Commander MAX

715006807



- Heavy-duty 1.5" (3.8 cm) diameter steel tubing.
- Inside and outside anti-corrosion coating with durable powder-coat finish.
- Provide additional protection for vehicle's front corners.
- Requires stock XT, XT-P or X mr bumper.
- Sold in pairs.
- Not EC compliant.

### Rear Bumpers

Commander, Commander MAX

715006808



- Rear bumper made of heavy-duty 1.5" (3.8 cm) diameter steel tubing.
- Protect vehicle bodywork and exhaust system.
- Inside and outside anti-corrosion coating with durable powder-coat finish.
- Compatible with Mud Flaps.
- Not EC compliant.

## Maverick Trail & Maverick Sport Bumpers

### Front Trail Bumper

Maverick Trail, Maverick Sport,  
Maverick Sport MAX

■ 715003680 · Black  
■ 715003681 · Sunburst Yellow

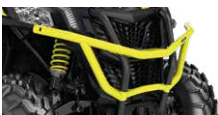

- Front bumper made of heavy-duty 1.5" (3.8 cm) diameter steel tubing.
- Completes the stock bumper for more front coverage and essential vehicle protection for trail riders.
- Inside and outside anti-corrosion coating with durable powder coat finish.
- Includes integrated mount points for seamless light installation.

### Rear Trail Bumper

Maverick Trail, Maverick Sport,  
Maverick Sport MAX

■ 715007109 · Black



- Rear bumper made of heavy-duty 1.5" (3.8 cm) diameter steel tubing.
- Protects vehicle bodywork and exhaust system.
- Inside and outside anti-corrosion coating with durable powder coat finish.
- Requires Licence Plate Holder (715007006) for installation on T-category models.

### Front Corner Protectors

Maverick Trail, Maverick Sport,  
Maverick Sport MAX

■ 715004912 · Black



- Heavy-duty 1.5" (3.8 cm) diameter steel tubing.
- Inside and outside anti-corrosion coating with durable powder coat finish.
- Provide additional protection for vehicle's front corners.
- Require Front Trail Bumper (715003680 / 715003681) for installation.
- Sold in pairs.



## Rancher Rear Bumper

Maverick Trail, Maverick Sport,  
Maverick Sport MAX

**715004304**



- Heavy-duty protection made of 1.5" (3.8 cm) diameter steel tubing, perfect for farm, ranch and forestry applications.
- Inside and outside anti-corrosion coating with durable powder coat finish.
- Offers full rear coverage with integrated tail light protectors.
- Not compliant with T-category.
- Requires License Plate Holder (715007006) for installation on T-category models

## S3<sup>†</sup> Front Bumper

Maverick Trail, Maverick Sport,  
Maverick Sport MAX

■ **715005121** · Black



- Made of extra durable 1.5" (3.8 cm) diameter steel tubing.
- Inside and outside anti-corrosion coating with durable powder coat finish.
- Replaces stock bumper and adds superior protection for mud-riding enthusiasts.
- Integrated mount points for lights.
- Hook support anchor allows you to keep the winch hook within easy reach when riding in deep mud.
- "S3 for Can-Am" branded.
- Winch not included.

## S3<sup>†</sup> Rear Bumper

Maverick Trail, Maverick Sport,  
Maverick Sport MAX

■ **715005122** · Black



- Made of extra durable 1.5" (3.8 cm) diameter steel.
- Inside and outside anti-corrosion coating with durable powder coat finish.
- Added heavy-duty protection in extreme driving conditions—protects vehicle bodywork and exhaust system.
- Permits installation of a winch at a higher location to improve accessibility in mud-riding conditions.
- Engineered to sustain heavy winch loads without damaging the vehicle's frame.
- Compatible with Can-Am HD and WARN VRX winches—Rear Winch Harness (715006008) is required to install a winch on the bumper.
- Includes a License Plate Support Mount (not compliant with T-category).
- Not EC compliant.
- "S3 for Can-Am" branded.
- Winch not included.

## Rear Winch Harness

(Not illustrated)

Maverick Trail, Maverick Sport, Maverick Sport MAX

**715006008**

## Rock Sliders

### Rock Sliders

Commander, Maverick Trail, Maverick Sport (except Xrc)

■ **715003689** · Black

Commander MAX, Maverick Sport MAX

■ **715004754** · Black



- Made of heavy-duty 1.5" (3.8 cm) diameter steel tubing.
- Inside and outside anti-corrosion coating with durable powder coat finish.
- Protect vehicle's rocker panels and undercarriage against large obstacles.
- Sold in pairs.

## Intrusion Bars

### Front Intrusion Bar

Commander, Commander MAX,  
Maverick Trail, Maverick Sport,  
Maverick Sport MAX

**715003872**



- Steel intrusion bar matches perfectly with vehicle's styling.
- Inside and outside anti-corrosion coating with durable powder coat finish.
- Provides additional protection by preventing large objects from entering the driver/passenger area.
- Tube design reduces obstructed lines of sight and blind spots for better visibility.
- Not compatible with windshields and Soft Door Panels.

### Lonestar Racing Rear Intrusion Bar

Maverick Trail, Maverick Sport

■ **715005134** · Black

■ **715004874** · Can-Am Red





- Race-engineered to Lonestar Racing's trademark standards for toughness, these stylishly crafted accessories will also enhance your vehicle with visual impact.
- Made of 1.5" (3.8 cm) diameter steel tubing with durable powder coat finish.
- Provides additional protection for driver and passenger.
- Not compatible with the Sport Roof, rear panels and windows, All-Terrain Trunk Cover.
- Not compatible with Xmr models or with the Snorkel Kit.
- Not compatible with S&B particle separator.

## Fender Flares

<b>Fender Flares</b>	Commander, Commander MAX	<b>715006814</b>
	<ul style="list-style-type: none"> <li>Fender flares made from injection-molded polypropylene.</li> <li>Keep mud and debris out of vehicle.</li> <li>Designed for quick and easy installation.</li> </ul>	<ul style="list-style-type: none"> <li>Front and rear extensions and mounting hardware included.</li> <li>Increase vehicle's overall width by 3" (8 cm) when installed on Commander and Commander MAX models.</li> </ul>

<b>2" (51 mm) Fender Flares</b>	Maverick Trail	<b>715004958</b>
	<ul style="list-style-type: none"> <li>Extended fender flares made from injection-molded polypropylene.</li> <li>Keep mud and debris out of vehicle.</li> <li>Designed for quick and easy installation.</li> </ul>	<ul style="list-style-type: none"> <li>Include front and rear extensions, mounting hardware and Fender Flare Rear Extensions (715004404).</li> <li>Increase vehicle's overall width by 3.5" (8.9 cm).</li> </ul>

<b>Fender Flare Rear Extensions</b>	Maverick Trail	<b>715004404</b>
	<ul style="list-style-type: none"> <li>Help tail light stay clean from debris and mud to remain visible. Can be installed with 2" (51 mm) Fender Flares (715003625).</li> <li>Made from injection-molded polypropylene for best fit and finish.</li> </ul>	<ul style="list-style-type: none"> <li>Sold in pairs.</li> <li>Included with the 2" (51 mm) Fender Flares (715004958) and with the Fender Flare Extensions (715004462).</li> </ul>

<b>3" (76 mm) Fender Flares</b>	Maverick Trail, Maverick Sport, Maverick Sport MAX	<b>715004959</b>
	<ul style="list-style-type: none"> <li>Fender flares made from injection-molded polypropylene.</li> <li>Keep mud and debris out of vehicle.</li> <li>Designed for quick and easy installation.</li> <li>Include front and rear extensions and mounting hardware.</li> </ul>	<ul style="list-style-type: none"> <li>Increase vehicle's overall width by 6" (15.3 cm) when installed on Maverick Trail models.</li> <li>Standard on Maverick Sport models.</li> </ul>

<b>Fender Flare Rear Extensions</b>	Maverick Trail, Maverick Sport, Maverick Sport MAX	<b>715004462</b>
	<ul style="list-style-type: none"> <li>Block terrain debris from kicking up onto you as you ride or damaging your vehicle thanks to these extra-large Fender Flare Extensions, which also include Rear Fender Flare Extensions (715004404) for added protection from mud/snow, especially when riding with track kits.</li> <li>Made from injection-molded polypropylene for best fit and finish.</li> </ul>	<ul style="list-style-type: none"> <li>Not compatible with 2" (51 mm) Fender Flares.</li> <li>Include front and rear extensions.</li> <li>For Maverick Trail, must be used with 3" (76 mm) Fender Flares (715004959).</li> <li>Standard on Maverick Sport X mr models.</li> </ul>

## Others

<b>License Plate Holder</b>	Maverick Trail, Maverick Sport, Maverick Sport MAX	<b>715007006</b>
	<ul style="list-style-type: none"> <li>Supports your license plate on the Rear Trail Bumper.</li> <li>Plate lights can be relocated on bumper to light up license plate.</li> <li>Require Rear Trail Bumper (715007109) for installation.</li> <li>EC compliant.</li> </ul>	

<b>Tail Light Protectors</b>	Maverick Trail, Maverick Sport, Maverick Sport MAX	<b>715003692</b>
	<ul style="list-style-type: none"> <li>Anti-corrosion coating with durable powder coat finish.</li> <li>Rugged style, aggressive look.</li> <li>Sold in pairs.</li> <li>Not compliant with T-category.</li> </ul>	

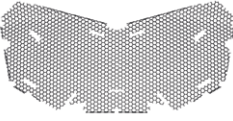
<b>Radiator Protector</b>	Maverick Trail, Maverick Sport, Maverick Sport MAX	<b>715003700</b>
	<ul style="list-style-type: none"> <li>Perforated steel shield mounted over the radiator face, providing protection from stones and branches.</li> <li>Not recommended for winter use.</li> </ul>	

# LINQ: EASY ON, EASY OFF CARGO

## COMMANDER'S LINQ ACCESSORIES

### Mounting location and requirements

<ul style="list-style-type: none"> <li>No tools needed: Quickly install and remove accessories by hand.</li> <li>Equip your Can-Am for specialized tasks in no time.</li> <li>Sturdy mounting system that holds up to the roughest terrain.</li> </ul>	Vehicle Standard Cargo Box	LinQ Cargo Rack 715006815	Adventure Roof Rack 715004095	Deluxe Headache Rack 715006823	Rear Adventure Rack 715006809	Passenger Seat Base
<b>LinQ Accessories with 16" Base</b>		<ul style="list-style-type: none"> <li>LinQ anchors mounted 16 inches apart, center-to-center.</li> <li>Lower loading capacity than the LinQ with 36" base accessories.</li> <li>Can be used on Can-Am ATV and SxS vehicles, Can-Am Spyder and Ryker vehicles, Sea-Doo watercraft and Ski-Doo snowmobiles.</li> </ul>				
<b>LinQ 4.2 Gal Cooler</b> 295100698 • White 219400964 • Black	LinQ Base Installation Kit 715008125	LinQ Base Installation Kit 715008125	LinQ Base Installation Kit 715008125			
<b>LinQ Tool Kit</b> 715006829	No further requirements	No further requirements	No further requirements			
<b>LinQ Tool Box</b> 715008111						
<b>LinQ SR 5.5 Gal (21 L) Bag</b> 860202449	LinQ Base Installation Kit 715008125	LinQ Base Installation Kit 715008125	LinQ Base Installation Kit 715008125	LinQ Base Installation Kit 715008125	LinQ Base Installation Kit 715008125	Passenger Seat LinQ Anchor Kit 715003951
<b>LinQ 4.5 Gal (17 L) Sport Bag</b> 860202447						
<b>LinQ Modular Box</b> 715005494 • (10 L) 715007112 • (20 L) 715006830 • (30 L)	No further requirements	No further requirements	No further requirements			
<b>LinQ Roll-Top Bag</b> 715008110	LinQ Base Installation Kit 715008125	LinQ Base Installation Kit 715008125	LinQ Base Installation Kit 715008125			
<b>LinQ Accessories with 36" Base</b>		<ul style="list-style-type: none"> <li>Mount on LinQ racks often used by Can-Am ORV vehicles.</li> <li>Higher loading capacity than the LinQ with 16" base accessories.</li> <li>Usage is limited to Can-Am ORV vehicles.</li> </ul>				
<b>LinQ 12 Gal (45 L) Cargo Box</b> 715003879	No compatibility	No further requirements	No compatibility	No compatibility	No compatibility	No compatibility
<b>LinQ 23 Gal (86 L) Trunk Box</b> 715004923		No compatibility				
<b>LinQ Audio Box</b> 715003018		No compatibility				
<b>LinQ Cooler</b> 715004778 • Black 715004698 • Gray		No compatibility				
<b>LinQ OGIO® Bag</b> 715002923 • Black		No further requirements				
<b>LinQ Heavy Duty Basket</b> 715001215		No further requirements				
<b>LinQ Low Profile Basket</b> 715004282		No further requirements				
<b>LinQ Holders</b>						
<b>LinQ Gear Grips</b> 715005340	No further requirements	No further requirements	Side wall installation LinQ Adapters 715003058	Side wall installation LinQ Adapters 715003058	Side wall installation LinQ Adapters 715003058	Passenger Seat LinQ Anchor Kit 715003951
<b>LinQ Tool Holder</b> 715007358						

# MAVERICK TRAIL / SPORT LINQ ACCESSORIES

## Mounting location and requirements

<ul style="list-style-type: none"> <li>No tools needed: Quickly install and remove accessories by hand.</li> <li>Equip your Can-Am for specialized tasks in no time.</li> <li>Sturdy mounting system that holds up to the roughest terrain.</li> </ul>	Vehicle Standard Cargo Box	LinQ Cargo Rack <b>715003702</b>	Adventure Roof Rack <b>715004095</b>	LinQ Pivoting Rack <b>715008297</b>	All-Terrain Trunk Cover <b>715003701</b>	Passenger Seat Base
--	----------------------------	-------------------------------------	---	--	---	---------------------

### LinQ Accessories with 16" Base

LinQ anchors mounted 16 inches apart, center-to-center. Lower loading capacity than the LinQ with 36" base accessories. Can be used on Can-Am ATV and SxS vehicles, Can-Am Spyder and Ryker vehicles, Sea-Doo watercraft and Ski-Doo snowmobiles.

<b>LinQ 4.2 Gal Cooler</b> 295100698 • White 219400964 • Black	LinQ Base Installation Kit <b>715008125</b>	No compatibility	LinQ Base Installation Kit <b>715008125</b>	LinQ Anchor Adapter Kit <b>715004960</b>	LinQ Base Installation Kit <b>715008125</b>	Passenger Seat LinQ Anchor Kit <b>715003951</b>
<b>LinQ Tool Kit</b> 715006829	No further requirements	No further requirements	No further requirements	No further requirements	No further requirements	No further requirements
<b>LinQ Tool Box</b> 715008111	LinQ Base Installation Kit <b>715008125</b>	No compatibility	LinQ Base Installation Kit <b>715008125</b>	LinQ Anchor Adapter Kit <b>715004960</b>	LinQ Base Installation Kit <b>715008125</b>	Passenger Seat LinQ Anchor Kit <b>715003951</b>
<b>LinQ SR 5.5 Gal (21 L) Bag</b> 860202449						
<b>LinQ 4.5 Gal (17 L) Sport Bag</b> 860202447						
<b>LinQ Modular Box</b> 715005494 • (10 L) 715007112 • (20 L) 715006830 • (30 L)	No further requirements	No further requirements	No further requirements	No further requirements	No further requirements	No further requirements
<b>LinQ Roll-Top Bag</b> 715008110	LinQ Base Installation Kit <b>715008125</b>	No compatibility	LinQ Base Installation Kit <b>715008125</b>	LinQ Anchor Adapter Kit <b>715004960</b>	LinQ Base Installation Kit <b>715008125</b>	Passenger Seat LinQ Anchor Kit <b>715003951</b>

### LinQ Accessories with 36" Base

Mount on LinQ racks often used by Can-Am ORV vehicles. Higher loading capacity than the LinQ with 16" base accessories. Usage is limited to Can-Am ORV vehicles.

<b>LinQ 12 Gal (45 L) Cargo Box</b> 715003879	No compatibility	No further requirements	No compatibility	No further requirements	No compatibility	No compatibility
<b>LinQ 23 Gal (86 L) Trunk Box</b> 715004923		No compatibility				
<b>LinQ 32 Gal (121 L) Trunk Box</b> 715001747		No further requirements				
<b>LinQ Audio Box</b> 715003018		No compatibility				
<b>LinQ Cooler</b> 715004778 • Black 715004698 • Gray		No further requirements				
<b>LinQ OGIO Bag</b> 715002923 • Black		No compatibility				
<b>LinQ Heavy Duty Basket</b> 715001215		No further requirements				
<b>LinQ Low Profile Basket</b> 715004282		No further requirements				

### LinQ Holders

<b>LinQ Gear Grips</b> 715005340	No further requirements (when installed on side walls)	No compatibility	Side wall installation LinQ Adapters <b>715003058</b>	No further requirements	LinQ Base Installation Kit <b>715008125</b>	No further requirements
<b>LinQ Tool Holder</b> 715007358						



## LinQ Accessories with 16" Base

### LinQ Modular Box



Commander, Commander MAX,  
Maverick Trail, Maverick Sport,  
Maverick Sport MAX

715005494 · (10 L)  
715007112 · (20 L)  
715006830 · (30 L)

- Allows stacking of other modular boxes to always have the right gear accessible.
- Always have the right box size to fit everything.
- Can be installed on any LinQ base with a 16" width.
- See table for installation location and requirements.

### Thermal Insert for LinQ Modular Box (10 L)



Commander, Commander MAX,  
Maverick Trail, Maverick Sport,  
Maverick Sport MAX

219401110

- Insulated liner.
- Fits very well in the LinQ Modular Box (10 L).
- Can contain seven 355 ml cans.
- Keeps ice cold for one day.
- Interior dimensions: 9" L x 17" W x 2½" H.

### LinQ Tool Box



Commander, Commander MAX,  
Maverick Trail, Maverick Sport,  
Maverick Sport MAX

715008111

- High precision injected HDPE construction provides rigidity and durability.
- 5 gal (19 L) maximum capacity.
- Weather-resistant, sealed and lockable cover.
- Easy one-second on/off tool-less system.
- All the benefits of LinQ—simple, fast and secure.
- See table for installation location and requirements.

### LinQ Tool Kit



Commander, Commander MAX,  
Maverick Trail, Maverick Sport,  
Maverick Sport MAX

715006829

- Includes:
  - Cutter pliers
  - Long-nose pliers
  - Locking pliers
  - Ratchet wrench ¾" drive
  - 6" ratchet extension
  - Integrated CVT belt storage location (belt not included)
  - Long-socket 19 mm ¾" drive - 6 pts
  - Socket 18 mm ¾" drive
  - Long-socket 17 mm ¾" drive - 6 pts
  - Socket 15 mm ¾" drive
  - Socket 13 mm ¾" drive
  - Socket 10 mm ¾" drive
  - Socket 8 mm ¾" drive
  - Combined wrench 19 mm
  - Combined wrench 18 mm
  - Combined wrench 15 mm
  - Combined wrench 13 mm
  - Combined wrench 10 mm
  - Combined wrench 8 mm
  - Socket Torx T30 ¾" drive
  - Socket Torx T20 ¾" drive
  - Breaker bar ¾" drive
- See table for installation location and requirements

### LinQ 4.2 Gal (16 L) Cooler



Commander, Commander MAX,  
Maverick Trail, Maverick Sport,  
Maverick Sport MAX

■ 219400964 · Black  
295100698 · White

- All the benefits of LinQ—simple, fast and secure.
- Rotomolded construction for exceptional rigidity and durability.
- Premium-quality foam insulation for optimal ice retention.
- Uses LinQ mounting system (Patent US 8777531 and US 8875830).
- Easy one-second on/off tool-less system.
- Can contain twenty 355 ml cans.
- Keeps ice cold for three days.
- Exterior dimensions: 13" L x 20" W x 10" H.
- Interior dimensions: 9" L x 17" W x 7" H.
- See table for installation location and requirements.

### LinQ 4.5 Gal (17 L) Sport Bag



Commander, Commander MAX,  
Maverick Trail, Maverick Sport,  
Maverick Sport MAX

860202447

- 17-liter (4.5 US gallon, 1,037 cu. in.) capacity.
- Rigid bottom, semi-rigid top.
- See table for installation location and requirements.

<b>SR 5.5 Gal (21 L) LinQ Bag</b>	Commander, Commander MAX, Maverick Trail, Maverick Sport, Maverick Sport MAX	<b>860202449</b>
-----------------------------------	--	------------------



- All the benefits of LinQ—simple, fast and secure.
- Semi-rigid expandable bag.
- 5.5 gal (21 L) capacity.
- Utilizes LinQ mounting system (Patent US 8777531 and US 8875830).
- Easy one-second on/off tool-less system.
- See table for installation location and requirements.

<b>LinQ Roll-Top Bag</b>	Commander, Commander MAX, Maverick Trail, Maverick Sport, Maverick Sport MAX	<b>715008110</b>
--------------------------	--	------------------



- Fully waterproof roll-top dry bag will securely store and confine your equipment.
- LinQ mounted using heavy-duty rigid plastic base.
- High capacity storage solution (40 L).
- Bottom foam liner for additional equipment protection.
- Integrated handle for easy transportation on/off the vehicle.
- Dimensions: 14" L x 19" W x adjustable H.
- See table for installation location and requirements.

## LinQ Accessories with 36" Base

<b>LinQ Premium Storage Bag by OGIO</b>	Commander, Commander MAX, Maverick Trail, Maverick Sport, Maverick Sport MAX	■ <b>715002923</b> · Black
---	--	----------------------------



- Tool-less installation and removal thanks to the LinQ system.
- 17.2 gal (65 L) capacity semi-rigid cargo bag ideal for carrying anything you need on your vehicle.
- Buckle and elastic closure with a rubber seal that protects dust from entering the bag.
- 3-section lid for partial or full access to your bag.
- Inside separators for optimal bag organization.
- See table for installation location and requirements.

<b>LinQ 12 Gal (45 L) Cargo Box</b>	Commander, Commander MAX, Maverick Trail, Maverick Sport, Maverick Sport MAX	<b>715003879</b>
-------------------------------------	--	------------------



- LinQ mounted for easy-on, easy-off installation.
- Holds cargo safely and securely while riding.
- See table for installation location and requirements.

<b>LinQ 23 Gal (86 L) Trunk Box</b>	Commander, Commander MAX, Maverick Trail, Maverick Sport, Maverick Sport MAX	<b>715004923</b>
-------------------------------------	--	------------------



- LinQ mounted for easy-on, easy-off installation.
- Holds cargo safely and securely while riding.
- See table for installation location and requirements.

<b>LinQ 11.5 Gal (43 L) Audio Cargo Box</b>	Maverick Trail, Maverick Sport, Maverick Sport MAX	<b>715003018</b>
---	---	------------------



- An affordable and quick solution for adding music and storage to your next ride.
- The rear installation does not use up any cab space and allows easy listening at an average speed.
- Mounts on/off easily to hold/carry cargo safely and securely.
- Backlit control panel perfect for night riding.
- Water-resistant speakers.
- The Bluetooth<sup>®</sup> enabled receiver and 6.5" (16.5 cm) speakers are smartly concealed and integrated in the cover.
- Automatic shut-off function protects your battery by turning the system off after 10 minutes of inactivity.
- See table for installation location and requirements.

<b>LinQ 8 Gal (30 L) Cooler Box</b>	Commander, Commander MAX, Maverick Trail, Maverick Sport, Maverick Sport MAX	■ <b>715004778</b> · Black ■ <b>715004698</b> · Gray
-------------------------------------	--	---



- LinQ mounted for easy-on, easy-off installation.
- Rotomolded construction provides exceptional rigidity and durability.
- Premium-quality foam insulation for optimal ice retention.
- Integrated, fully removable compartment protects food.
- Robust rubber latches keep the cover tightly closed.
- Weather-resistant.
- Convenient drain plug.
- See table for installation location and requirements.

<b>LinQ 32 Gal (121 L) Trunk Box</b>	Maverick Trail, Maverick Sport, Maverick Sport MAX	<b>715001747</b> · Black (Rear tail light included)
	European Version (EC compliant)	<b>715001748</b> · (No rear tail light)



- Equipped with the LinQ system, the rear trunk box plugs in and out in seconds.
- 32 gal (121 L) load capacity with unobstructed space to maximize storage room and access to the trunk's interior.
- Made of injection-molded polyethylene, double walled in critical areas.
- The fully sealed lid protects your belongings from dust, moisture and the elements.
- Trunk Box Panels available in many colors to match your vehicle (sold separately).
- See table for installation location and requirements.

<b>LinQ 32 Gal (121 L) Trunk Box Panels</b>	Maverick Trail, Maverick Sport, Maverick Sport MAX
---	--

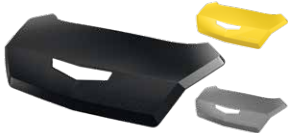

- Color panels to match the LinQ 32 gal (121 L) to your vehicle (715001747 / 715001748).

- **715001391** · Black
- **715001392** · Yellow
- **715001395** · Viper Red
- **715002481** · White
- **715002480** · Light Gray
- **715002984** · Octane Blue
- **715002985** · Manta Green
- **715002986** · Can-Am Red
- **715006119** · Orange Crush
- **715006120** · Squadron Green
- **715007074** · Tundra Green

European Version (EC compliant). No rear tail light.

- **715001397** · Black
- **715001398** · Yellow
- **715002483** · White
- **715006121** · Can-Am Red
- **715006122** · Manta Green
- **715006123** · Orange Crush
- **715006124** · Viper Red

<b>LinQ Heavy-Duty Basket</b>	Commander, Commander MAX, Maverick Trail, Maverick Sport, Maverick Sport MAX	<b>715001215</b>
-------------------------------	--	------------------



- Made of high-strength, low-alloy steel.
- LinQ mount for easy-on, easy-off installation.
- See table for installation location and requirements.

<b>LinQ Low Profile Basket</b>	Commander, Commander MAX, Maverick Trail, Maverick Sport, Maverick Sport MAX	<b>715004282</b>
--------------------------------	--	------------------



- Low profile, open basket increases cargo space.
- Perfect for easy access to tools, rope, winch and plow accessories.
- Multiple bungee cord and tie-down anchor points.
- Made of impact-resistant injected polypropylene.
- See table for installation location and requirements.

## LinQ Holders

<b>LinQ Tool Holder</b>	Commander, Commander MAX, Maverick Trail, Maverick Sport, Maverick Sport MAX	<b>715007358</b>
-------------------------	--	------------------



- Ultra-versatile tool holder.
- Convenient swivel-latch allows tools to be stored in any orientation.
- Sold in pairs.
- See table for installation location and requirements.

<b>LinQ Gear Grips</b>	Commander, Commander MAX, Maverick Trail, Maverick Sport, Maverick Sport MAX	<b>715005340</b>
------------------------	--	------------------



- Durable and flexible grips provide a custom fit for a variety of items from 1" to 4" (2.5 cm to 10 cm) in diameter.
- Heavy-duty design for carrying bows, fishing poles, rakes, farm tools and more.
- Quick-release button opens grip quickly for easy access to gear.
- Heavy-duty base system built for the toughest adventures.
- Make transporting your tools a snap by combining the Gear Grips with the LinQ system.
- 360° orientation.
- Sold in pairs.
- See table for installation and requirements.

## LinQ Accessories

### LinQ Adapter

(Not illustrated)

Commander, Commander MAX,  
Maverick Trail, Maverick Sport,  
Maverick Sport MAX

715003058

- Sold in pack of 4.

### LinQ Base Installation Kit

Commander, Commander MAX,  
Maverick Trail, Maverick Sport,  
Maverick Sport MAX

715008125



- Unique mounting fastener usable on any LinQ system accessory.
- Included: 2 cargo LinQ bases and hardware.

### LinQ Lock

Commander, Commander MAX,  
Maverick Trail, Maverick Sport,  
Maverick Sport MAX

860201968



- Simple way to securely lock most LinQ accessories.
- Lock cover protects lock from the elements.
- Corrosion resistant.
- Pack of 1, includes 2 keys.
- Not compatible with LinQ 4.2 US Gal (16 L) Cooler, LinQ Tool Box, LinQ Tool Holder and LinQ Gear Grips.

### LinQ Replacement Part

Maverick Trail, Maverick Sport,  
Maverick Sport MAX

715001707



- Unique mounting fastener usable on any LinQ system accessory.
- Tool-less installation and removal.
- Sold in pairs.

### LinQ Anchor Adapter kit

Maverick Trail, Maverick Sport,  
Maverick Sport MAX

715004960



- Allows the installation of LinQ accessories with 16" base on LinQ racks.
- Tool-less installation and removal.
- LinQ pivoting rack is required for installation.

# CARGO & STORAGE

## Cargo

### LinQ Cargo Rack

Commander, Commander MAX

715006815

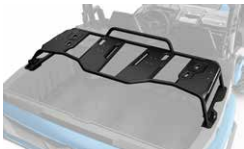

- Strong, durable steel rack 7/8".
- Easy and tool-less installation with LinQ system.
- Allows the installation of LinQ accessories.
- Allows multi-level storage on cargo bed.
- Helps keep cargo securely in place.
- Multiple bungee cord and tie-down points.
- Kit includes LinQ Base 36".
- 15" clearance under the rack for other cargo.
- Not compatible with 715006816.

### Integrated Tailgate Extension

Commander, Commander MAX

715006810



- Integrated design that lets the extension fold away inside the tailgate when not needed.
- Steel construction for rugged durability.
- Not EC compliant.

### Tonneau Cover

Commander, Commander MAX

715006816



- Fitted to cover all of the items in your cargo box.
- Prevents splash from entering the cargo box.
- Rolls up to the front.
- Easily removable for quick access.
- Not compatible with accessories that exceed the bed height.



## All-Terrain Trunk Cover

Maverick Trail, Maverick Sport (except X mr),  
Maverick Sport MAX

**715003701**



- Transforms your rear cargo area into a fully enclosed and weather-resistant car-like trunk box.
- Gas spring assisted opening.
- Integrated mounting location inside the trunk cover for Dome Light (715002455) (sold separately).
- Rotomolded construction provides exceptional rigidity.
- LinQ accessories can be installed on or inside the trunk cover.
- LinQ Base Installation Kit required for installation on the trunk cover.

## Fixed Tailgate

Maverick Trail, Maverick Sport,  
Maverick Sport MAX

**715004357**



- Rigid rotomolded construction.
- Encloses the rear cargo opening perfectly and helps keep cargo securely in place.
- Matches the vehicle's styling.

## Storage

### Soft Storage Bag

Commander, Commander MAX,  
Maverick Trail, Maverick Sport,  
Maverick Sport MAX

**715003759**



- 11.8 gal (45 L) capacity soft cargo bag designed with vehicle's rear in mind to maximize potential storage.
- 3-section bag.
- Transport gear in a weatherproof bag.

### Storage 2.6 Gal (10 L) Bag

Commander, Commander MAX,  
Maverick Trail, Maverick Sport,  
Maverick Sport MAX

**269502121**



- Roll-top dry bag for fully protecting your cargo from the elements.

### Overhead Storage Bags

Commander, Commander MAX,  
Maverick Trail, Maverick Sport,  
Maverick Sport MAX

**715005018**



- Weather-resistant bags, hold your gear safely and securely while riding.
- Include 2 overhead soft bags mounted on a tubular frame that sits between cage and roof.
- 2.4 gal (9 L) total capacity.
- Bimini Roof with sun visor or Sport Roof needed for installation.
- Not compatible with the Complete Wet Sounds Audio System.

### Shoulder Storage Bag

Commander, Commander MAX,  
Maverick Trail, Maverick Sport,  
Maverick Sport MAX

**715005019**



- Weather-resistant semi-rigid bag holds your gear safely and securely while riding.
- Bag attaches in unused space between the seats to increase your vehicle's cargo capacity.
- 2.8 gal (10.5 L) capacity.

### Removable Central Storage Bag

Commander MAX, Maverick Sport MAX

**715004794**



- Weather-resistant bag holds your gear safely and securely while riding.
- Both front and rear passengers can access the bag's content.
- Designed as a 1.3 gal (5.2 L) capacity pocket, also equipped with inner netting compartments and side pockets.
- Can be removed in seconds and includes shoulder strap for transportation.
- Perfect to bring your gear on and off your vehicle.

**NEW Passenger Storage Seat Bag**Commander, Commander MAX, Maverick Trail,  
Maverick Sport, Maverick Sport MAX**715008080**

- This weather-resistant bag holds your gear safely and securely while you ride.
- Bag settling on the passenger seat to increase the vehicle's cargo capacity.
- This bag features a 14.5 gal (55 L) storage capacity and is divided into two compartments.
- The top compartment is insulated to keep your beverages cold and includes two cup holders.
- Additional pocket inside for additional storage, such as a cell phone.
- The bottom compartment is accessible from both sides and serves as a large pocket for storing various items.
- The detachable pocket at the front of the bag can be used as a garbage bag.

**Soft Cooler**Commander, Commander MAX,  
Maverick Trail, Maverick Sport,  
Maverick Sport MAX**715003728**

- Soft cooler made of durable canvas.
- Removable shoulder strap and carry handles.
- Foam insulation and water-resistant interior liner.
- 2.2 gal (4.5 L) capacity.

# RACKS & HOLDERS

**Adventure Roof Rack**

Commander MAX, Maverick Sport MAX

**715004095**

- Ideal cargo solution for packing everything you need to live your off-road experience fully and completely.
- Built with heavy-duty 1.5" (3.8 cm) and 1.25" (3.2 cm) diameter steel tubing.
- Loads of up to 75 lb (34 kg).
- LinQ support plates allow for installation of accessories with 16" base.
- Integrated mounting points for the installation of the 39" (99 cm) Double Stacked LED Bar (front).
- Features anchor points for spare tire attachment.
- Spare Tire Tie-Downs sold separately.
- Add the Cargo Box Net to secure and confine your cargo in the rack.
- Can be installed without a roof or with Sport Roof only.

**Rear Adventure Rack**

Commander, Commander MAX

**715006809**

- Made of heavy-duty steel.
- Increases the cargo versatility of the vehicle.
- Allows a Commander 2-up to fit a MAX Sport Roof or Bimini Roof on top to protect the cargo area.
- Allows a Commander 2-up to fit MAX Adventure Roof Rack to increase cargo capacity.
- Not compatible with other bed installed accessories.

**Adventure Rack Enclosure**Commander  
Commander MAX**715006818****715008246**

- Works with Rear Adventure Rack.
- Rear-panel zip-type windows with roll-down feature.
- Covers all accessories mounted inside of the Rear Adventure Rack.
- Compatible only with Sport Roof.
- Compatible with Track Kit and Pre-filter only in Pickup configuration.
- Track Kit and Pre-filter are not compatible with the SUV configuration.
- Not compatible with snorkel kits or X mr models.

**Cargo Bed Rails**

Commander, Commander MAX

**715006824**

- Add an integrated tie-down area to your cargo box.
- Added cargo box protection.
- Inside and outside anti-corrosion coating with durable powder-coat finish.
- Heavy-duty 1" (2.5 cm) diameter steel tube construction.
- Adds height to the bed side wall and serves as a tie-down point.
- Sold in pairs.

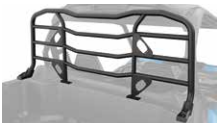
**Deluxe Headache Rack**Commander, Commander MAX  
(except X mr models)**715006823**

- Protects cab from cargo load.
- Compatible with cargo bed rails.
- Not compatible with Snorkel Kit (715003705).

<b>LinQ Pivoting Rack</b>	Maverick Trail, Maverick Sport, Maverick Sport MAX	<b>715008297</b>
	<ul style="list-style-type: none"> <li>LinQ latched rack allows for extra LinQ mounted accessories or the addition of ATV LinQ rack extensions.</li> <li>Includes custom tie-down strap for fast spare tire installation or removal (tire not included).</li> <li>Gas-cylinder pivot action, locks in the raised position.</li> <li>Not compatible with Gear Rail (715003703), Lonestar Racing and DragonFire tire carrier, Lonestar Racing Number Plate, Rear Intrusion Bars and LinQ Cargo Rack.</li> <li>Compatible with the All-Terrain Trunk Cover.</li> </ul>	
<b>LinQ Rack Extension</b>	Maverick Trail, Maverick Sport, Maverick Sport MAX	<b>715003771</b>
	<ul style="list-style-type: none"> <li>Made of strong and durable die-cast aluminum.</li> <li>Helps to keep cargo securely in place.</li> <li>Easy and tool-less installation thanks to the LinQ system.</li> </ul>	
<b>LinQ Cargo Rack</b>	Maverick Trail, Maverick Sport, Maverick Sport MAX	<b>715003702</b>
	<ul style="list-style-type: none"> <li>Made of durable die-cast aluminum and strong aluminum tubing frame.</li> <li>Allows the installation of LinQ Trunk Boxes on top and the addition of more LinQ accessories in cargo box.</li> <li>Easy and tool-less installation thanks to the LinQ system.</li> </ul>	
<b>Spare Tire Carrier</b>	Maverick Trail, Maverick Sport, Maverick Sport MAX	<b>715004471</b>
	<ul style="list-style-type: none"> <li>Holds spare tire in place.</li> <li>Designed for fast tire removal.</li> <li>Can hold tires up to 30" in diameter (tire is not included).</li> <li>Rear bumper mounted, does not encumber the cargo area.</li> <li>Made of heavy-duty 1.5" (3.8 cm) diameter steel tubing.</li> <li>Inside and outside anti-corrosion coating with durable powder coat finish.</li> <li>Requires Rear Trail Bumper (715007109) or Rear Rancher Bumper (715004304).</li> </ul>	
<b>Cargo Box Net</b>	Commander, Commander MAX, Maverick Sport MAX	<b>715001371</b>
	<ul style="list-style-type: none"> <li>Solid net designed to secure and ensure the compact confinement of your Adventure Roof Rack.</li> </ul>	
<b>LinQ Tool and Gun Holder</b>	Commander, Commander MAX	<b>715005466</b>
	<ul style="list-style-type: none"> <li>2-in-1 holding rack can be used both on the job or on the hunt.</li> <li>Include 5 locations to securely hold tools and guns using rubber grips and retention straps at the top and a rubber mat with gunstock shaped molding at the bottom.</li> <li>Easy to remove, install or reposition using our simple and secure LinQ system.</li> <li>Can be attached at multiple positions along the cargo bed walls, facing inside or outside the bed.</li> <li>Can be attached on the inside of the cargo, behind the cab.</li> <li>Not compatible with Headache Rack.</li> </ul>	
<b>LinQ Gun Case</b>	Commander, Commander MAX, Maverick Trail, Maverick Sport, Maverick Sport MAX	<b>715004968</b>
	<ul style="list-style-type: none"> <li>Practical design allows you to store shotguns and rifles up to 52" (132 cm) even with optics.</li> <li>Adapt to different weapon shapes and features with foam cushions that can be repositioned.</li> <li>LinQ-mounted for efficient and secure storage, locked in place with only a quarter turn.</li> <li>No mount required on Commander and Commander MAX.</li> <li>Mount kit required for Maverick Trail, Maverick Sport and Maverick Sport MAX.</li> </ul>	
<b>LinQ Gun Case Mounting Kit</b>	Maverick Sport, Maverick Sport MAX, Maverick Trail	<b>715006444</b>
	<ul style="list-style-type: none"> <li>Required to install the Can-Am Gun Case on a Maverick Sport, Maverick Sport MAX and Maverick Trail.</li> <li>Allows you to install up to two LinQ gun cases.</li> </ul>	

<b>Stronghold Gun Boot Impact<sup>†</sup> by Kolpin<sup>†</sup></b>	Maverick Trail, Maverick Sport, Maverick Sport MAX	<b>705011442</b>
---	--	------------------



- Compact low-profile design with Kolpin Stronghold styling securely holds up to 52" (132 cm) long rifles and shotguns with optics.
- Includes a removable, shock absorbing foam Impact liner.
- Single-handed opening with an attached lid for quick access along with an integrated closure strap.
- For use with the Kolpin Stronghold Auto-Latch Mount System.

<b>Stronghold Auto-Latch Mount by Kolpin</b>	Maverick Trail, Maverick Sport, Maverick Sport MAX	<b>715003899</b>
--	--	------------------



- Auto-latching design provides quick and secure gun boot attachment to your vehicle.
- Bracket is made from rugged high-impact, reinforced nylon and coated steel.
- For use with Stronghold Gun Boot (705011442).
- Requires Gear Rail (715003703).

<b>Gear Rail</b>	Maverick Trail, Maverick Sport, Maverick Sport MAX	<b>715003703</b>
------------------	--	------------------



- Sturdy gear rail design with C-clamps attached on the roll cage.
- Offers mounting points for the Stronghold Auto-Latch Mount or for the Universal Saw Press by Kolpin.
- Can hold up to two gun boots.
- Not compatible with the Gun Boot 6.0 Impact by Kolpin (715001419).

<b>Universal Saw Press by Kolpin</b>	Maverick Trail, Maverick Sport, Maverick Sport MAX	<b>715001423</b>
--------------------------------------	--	------------------



- Specially crafted for transporting your chainsaw securely and safely aboard your side-by-side vehicle.
- Heavy-duty, black powder-coated metal bracket designed to attach any chainsaw model with up to a 20" (51 cm) bar.
- Rubber pads provide cushion and tight fit.
- Hinged design for quick removal.
- Holds saw in vertical position or 45° angle in either direction.
- Requires Gear Rail (715003703).
- Protective sheath included.

<b>Spare Tire Ratchet Tie-Downs</b>	Commander, Commander MAX, Maverick Trail, Maverick Sport, Maverick Sport MAX	<b>280000955</b>
-------------------------------------	--	------------------



- 3-way ratcheting tie-down strap with loop ends.
- Designed to securely hold spare tires on accessories equipped with integrated spare tire attachment points.
- Adjustable to accommodate most common UTV tire sizes.
- Ratchet and junction ring made of durable zinc-plated steel.
- Required for spare tire attachment on Adventure Roof Rack and LinQ Pivoting Rack.

<b>Heavy-Duty Ratchet Tie-Down</b>	Commander, Commander MAX, Maverick Trail, Maverick Sport, Maverick Sport MAX	<b>715008308</b>
------------------------------------	--	------------------



- 1,000 lb (454 kg) safe working load.
- 1.5 in. x 6 in. (38 mm x 1.8 mm) strap with BRP brands.
- Deluxe ratchet with rubber handle.
- Black-coated clip hooks.
- 12" (300 mm) webbing included.
- Pack of two.

<b>Bolt-On<sup>†</sup> Retractable Ratcheting Tie-Downs</b>	Commander, Commander MAX, Maverick Trail, Maverick Sport, Maverick Sport MAX	<b>295101072</b>
---	--	------------------



- Perfect for transporting your powersport vehicle or securing loads.
- Mounts easily: Bolts on any flat surface (e.g., truck bed or frame).
- 1" x 6' (2.5 cm x 1.8 m) tie-down strap with heavy-duty stitching that delivers a 500 lb (226 kg) working load strength and 1,500 lb (680 kg) break strength.
- Convenient retractable push button automatically slackens, spools and stores away strap, while the ratchet mechanism tightens the strap snugly to secure your vehicle or load into place.
- Rubber ratcheting handle provides firm grip, and the hook is vinyl coated to protect whatever surface it hooks into.
- Sold in pairs.

<b>Ratchet Tie-Downs</b>	Commander, Commander MAX, Maverick Trail, Maverick Sport, Maverick Sport MAX	<b>715008309</b> · Black/Gray
--------------------------	--	-------------------------------



- 400 lb (181 kg) safe working load.
- 1" x 10' (2.5 cm x 3 m) strap with Sea-Doo, Ski-Doo and Can-Am logos.
- Deluxe ratchet with rubber handle.
- Coated S hooks.
- Pack of 2.



# LIGHTS

## 2 Choose your lights

1 Choose your mount point	BAJA DESIGNS <sup>†</sup> LIGHTS				CAN-AM LIGHTS				
	10" (25 cm) LED Light Bar	XL Sport LED Lights (sold in pairs)	Squadron Sport LED Lights (sold in pairs)	XL80 LED Lights (sold in pairs)	10" Double Stacked LED Bar	15" Double Stacked LED Bar	39" Double Stacked LED Bar	4" Round LED Lights (sold in pairs)	3.5" Spot or Flood LED Lights (sold in pairs)
<b>XT &amp; X mr</b> Front Bumper <i>(Stock on XT, XT-P and X mr)</i>	710006819 + 715007049 (Power Cable)	710006821 + 715008865 (Power Cable)	710006820 + 715008865 (Power Cable)	710005041 + 715007049 (Power Cable)	715002933 + 715003670 (Power Cable)	715002934 + 715003670 (Power Cable)	NA	715002935 (4" Round), 715003665 (3.5" Flood) or 715003666 (3.5" Spot) + 715003670 (Power Cable)	
<b>Trail Bumper</b>	NA	710006821 + 715008865 (Power Cable)	710006820 + 715008865 (Power Cable)	710005041 + 715007049 (Power Cable)	715002933 + 715003670 (Power Cable)	NA	NA	715002935 (4" Round), 715003665 (3.5" Flood) or 715003666 (3.5" Spot) + 715003670 (Power Cable)	
<b>Commander Front Bumper</b>	710006819 + 715007049 (Power Cable)	710006821 + 715008865 (Power Cable)	710006820 + 715008865 (Power Cable)	710005041 + 715007049 (Power Cable)	NA	715002934 + 715003670 (Power Cable)	NA	715002935 (4" Round), 715003665 (3.5" Flood) or 715003666 (3.5" Spot) + 715003670 (Power Cable)	
<b>Sport Roof &amp; Bimini Roof</b>	710006819 + 715007049 (Power Cable) *Optional Overhead Switch Panel 715003669	710006821 + 715008865 (Power Cable) *Optional Overhead Switch Panel 715003669	710006820 + 715008865 (Power Cable) *Optional Overhead Switch Panel 715003669	710005041 + 715007049 (Power Cable) *Optional Overhead Switch Panel 715003669	715002933 + 715003670 (Power Cable) + 715003669 (Overhead Switch Panel)	715002934 + 715003669 (Overhead Switch Panel)	715004007 + 715005822 (Mounting Kit) *Optional Overhead Switch Panel 715003669	715002935 (4" Round), 715003665 (3.5" Flood) or 715003666 (3.5" Spot) + 715003669 (Overhead Switch Panel)	
<b>Top Roll Cage</b>	NA	NA	NA	NA	NA	NA	715004007 + 715005822 (Mounting Kit)	NA	NA
<b>Sport Roof Back Position</b>	NA	NA	NA	NA	NA	NA	NA	NA	715003665 or 715003666 + 715003669 + 715004910

## 3 Order

### Order all part numbers in intersecting box

*\*Note: When installing more than one light kit, additional light power cable or mounting kit is required.*

\*All lights are intended for off-road use only.

#### Baja Designs Light Power Cable

*(Not illustrated)*

Commander, Commander MAX,  
Maverick Trail, Maverick Sport,  
Maverick Sport MAX

**715008865**

- Required for installation of Baja Designs LED lights onto roof or bumper.
- Baja Designs XL Sport LED Lights and Baja Designs Squadron Sport LED Lights.

#### Baja Designs Light Power Cable

*(Not illustrated)*

Commander, Commander MAX, Maverick Trail,  
Maverick Sport, Maverick Sport MAX

**715007049**

- Required for installation of Baja Designs LED lights onto roof or bumper.
- 10" (25 cm) Baja Designs OnX6 LED Bars and Baja Designs XL80 LED Lights.

### Baja Designs 10" (25 cm) OnX6 LED Light Bar

Commander, Commander MAX,  
Maverick Trail, Maverick Sport,  
Maverick Sport Max

710006819



12,460  
lumens

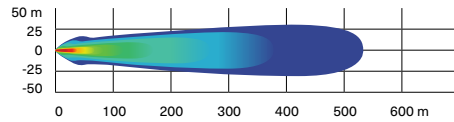

- 108 W light bar producing 12,460 lumens.
- Equipped with 6 Cree XM-L2 LEDs.
- Driving/combo light pattern for smooth blend of light for both near field applications and distance.

- Dual intensity (high/low) settings.
- Requires Baja Designs Light Power Cable.
- See table for installation location and requirements.
- Not EC compliant

### Baja Designs XL80 LED Lights

Commander, Commander MAX,  
Maverick Trail, Maverick Sport,  
Maverick Sport Max

710005041



9,500  
lumens

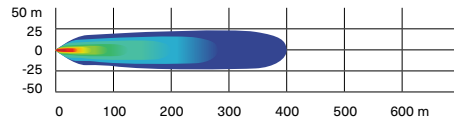

- 80 W per spot producing 9,500 lumens.
- Equipped with 4 Cree XHP50 LEDs per spot.
- Dual intensity (high/low) settings.
- Driving/combo light pattern for smooth blend of light for both near field applications and distance.

- Require Baja Designs Light Power Cable.
- Sold in pairs.
- Dimensions: 4.5" x 4.5" (11.4 cm x 11.4 cm).
- See table for installation location and requirements.
- Not EC compliant

### Baja Designs Squadron Sport LED Lights

Commander, Commander MAX,  
Maverick Trail, Maverick Sport,  
Maverick Sport Max

710006820



3,150  
lumens

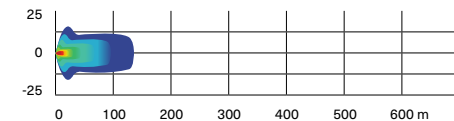

- 26 W per spot producing 3,150 lumens.
- Equipped with 4 Cree XP-G2 LEDs per spot.
- Wide cornering light pattern designed specifically for cornering, dust and/or fog conditions.

- Require Baja Designs Light Power Cable.
- Sold in pairs.
- Dimensions: 3" x 3" (7.6 cm x 7.6 cm).
- See table for installation location and requirements.
- Not EC compliant"

### Baja Designs XL Sport LED Lights

Commander, Commander MAX,  
Maverick Trail, Maverick Sport,  
Maverick Sport Max

710006821



3,150  
lumens

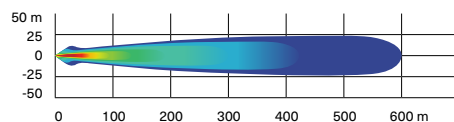

- 26 W per spot producing 3,150 lumens.
- Equipped with 4 Cree XP-G2 LEDs per spot.
- High Speed Spot features a longer and narrower beam focus for illumination farther down.

- Require Baja Designs Light Power Cable.
- Sold in pairs.
- Dimensions: 4.5" x 4.5" (11.4 cm x 11.4 cm).
- See table for installation location and requirements.
- Not EC compliant

### 10" (25 cm) Double Stacked LED Light Bar (60 W)

Commander, Commander MAX,  
Maverick Trail, Maverick Sport,  
Maverick Sport MAX

715002933



5,400  
lumens

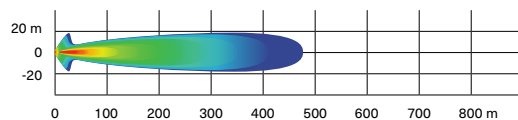

- Equipped with twelve 5 W Cree LEDs.
- 5,400 lumens.
- Packs a big punch for its size.
- Rugged and waterproof.
- Can be installed in stock XT and XT-P bumpers.

- Requires light power cable for installation.
- Lights up to more than 1,500 ft (460 m) in front of the vehicle and around 65 ft (20 m) wide on each side.
- See table for installation location and requirements.
- Not EC compliant

### 15" (38 cm) Double Stacked LED Light Bar (90 W)

Commander, Commander MAX,  
Maverick Trail, Maverick Sport,  
Maverick Sport Max

715002934



8,400  
lumens

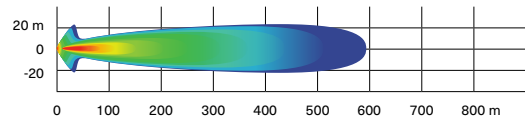

- Equipped with 18 5 W Cree LEDs.
- 8,400 lumens.
- Complements the Light Racks and most bumpers.
- Rugged and waterproof.

- Lights up to more than 1,900 ft (580 m) in front of the vehicle and around 65 ft (20 m) wide on each side.
- See table for installation location and requirements.
- Not EC compliant

### 39" (99 cm) Double Stacked LED Light Bar (270 W)

Commander, Commander MAX,  
Maverick Trail, Maverick Sport,  
Maverick Sport Max

715004007



24,300  
lumens

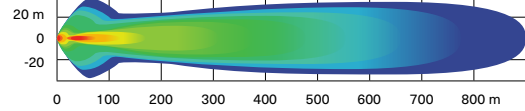

- Equipped with 54 5 W Cree LEDs.
- 24,300 lumens.
- Lights up to more than 2,900 ft. (900 m) in front of the vehicle and around 115 ft. (35 m) wide on each side.
- Compatible on the Adventure Roof Rack.

- Maverick Trail, Maverick Sport, Maverick Sport MAX: Requires Light Mounting Kit for 39" (99 cm) LED Light Bar (715005822) and/or Lonestar Racing Mounts for 39" (99 cm) Double Stacked LED Light Bar (715004877) for installation.
- Commander 2021 & up: Requires Light Mounting Kit for 39" (99 cm) LED Light Bar (715005822) and/or Lonestar Racing Mounts for 39" (99 cm) Double Stacked LED Light Bar (715004877) for installation.
- See table for installation location and requirements.
- Not EC compliant.

### 4" (10 cm) Round LED Lights (2 x 25 W)

Commander, Commander MAX,  
Maverick Trail, Maverick Sport,  
Maverick Sport Max

715002935



1,800  
lumens

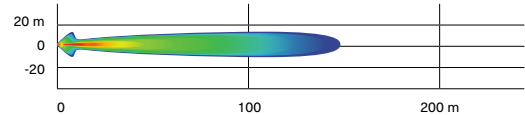

- 25 W LED spotlights.
- 1,800 lumens.
- Rugged and waterproof.
- Includes basic wiring and switch.
- Can-Am branded grill.

- Requires light power cable.
- Sold in pairs.
- Not EC compliant.
- See table for installation location and requirements.

### 3.5" (9 cm) LED Driving Lights (2 x 14 W)

Commander, Commander MAX,  
Maverick Trail, Maverick Sport,  
Maverick Sport Max

715003666



1,260  
lumens

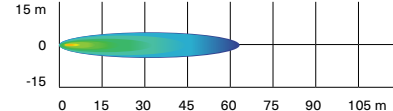

- 14 W LED lights producing 1,260 lumens each.
- Spot lens for a narrow and long light beam spread, ideal when driving at higher speeds.
- Equipped with six high-power LEDs in a heavy-duty die-cast aluminum housing.

- Features two attachment points. If one attachment point fails due to a collision, rotate to the next channel point and remount the light.
- Sold in pairs.
- CE certified
- See table for installation location and requirements.

### 3.5" (9 cm) LED Flood Lights (2 x 14 W)

Commander, Commander MAX,  
Maverick Trail, Maverick Sport,  
Maverick Sport Max

715003665



1,260  
lumens

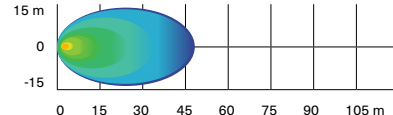

- 14 W LED lights producing 1,260 lumens each.
- Flood lens for a wide light beam spread, ideal for working applications like plowing or cornering. Suitable for dusty or foggy riding conditions.
- Equipped with six high-power LEDs in a heavy-duty die-cast aluminum housing.

- Features two attachment points. If one attachment point fails due to a collision, rotate to the next channel point and remount the light.
- Sold in pairs.
- CE certified
- See table for installation location and requirements.

<b>Light Power Cable</b> <i>(Not illustrated)</i>	Commander, Commander MAX Maverick Trail, Maverick Sport, Maverick Sport MAX	<b>715003670</b>
<ul style="list-style-type: none"> <li>• Power cable for installation of compatible Can-Am light kits on front bumpers or roof.</li> </ul>		
<b>LED Headlights Assembly</b>	Commander, Commander MAX, Maverick Trail, Maverick Sport, Maverick Sport MAX	<b>715003667</b>
	<ul style="list-style-type: none"> <li>• The headlights in this upgrade kit draw a maximum of 40 W (2 x 20 W) of power while providing brighter light output.</li> <li>• Lower power consumption and longer lasting than standard halogen bulbs.</li> <li>• Not EC compliant</li> </ul>	
<b>LED Signature Lights</b>	Commander, Commander MAX	<b>715006896</b>
	<ul style="list-style-type: none"> <li>• The stylish LED set adds a finishing touch, accentuating its aggressive stance.</li> </ul>	
<b>Can-Am LED Signature Lights</b>	Maverick Trail, Maverick Sport, Maverick Sport MAX	<b>715003673</b>
	<ul style="list-style-type: none"> <li>• Add style with a more aggressive look.</li> <li>• Use bright and energy efficient LEDs.</li> <li>• Do not give additional lighting for driving.</li> </ul>	
<b>Dome Light</b>	Commander, Commander MAX, Maverick Trail, Maverick Sport, Maverick Sport MAX	<b>715002455</b>
	<ul style="list-style-type: none"> <li>• LED array integrates perfectly with vehicle.</li> <li>• Wiring included.</li> <li>• Can be installed on cage, Sport Roof or All-Terrain Trunk Cover.</li> </ul>	
<b>Mounting Kit for 39" (99 cm) LED Light Bar</b> <i>(Not illustrated)</i>	Commander, Commander MAX, Maverick Trail, Maverick Sport, Maverick Sport MAX	<b>715005822</b>
<ul style="list-style-type: none"> <li>• Required for installation of the 39" (99 cm) double stacked LED Light Bar.</li> <li>• Includes wiring and support bracket.</li> <li>• Light Support Bar required for installation.</li> </ul>		
<b>Roof Power Cable</b> <i>(Not illustrated)</i>	Commander, Commander MAX, Maverick Trail, Maverick Sport, Maverick Sport MAX	<b>715003094</b>
<ul style="list-style-type: none"> <li>• Brings power from the battery.</li> <li>• Required for installation of some electrical accessories.</li> </ul>		
<b>Rear Lights Power Cable</b> <i>(Not illustrated)</i>	Commander, Commander MAX, Maverick Trail, Maverick Sport, Maverick Sport MAX	<b>715004910</b>
<ul style="list-style-type: none"> <li>• Power cable that allows you to install rear cargo lights on your vehicle.</li> <li>• Use in conjunction with the 3.5" (9 cm) LED Flood Lights (2 x 14 W) (sold separately).</li> <li>• This set-up will illuminate your rear cargo area and surroundings.</li> <li>• Sport Roof and Overhead Switch Panel (715003669) required.</li> </ul>		



# AUDIO & COMMUNICATION SYSTEMS

## Audio

<b>Complete Wet Sounds<sup>†</sup> Audio System</b>	Commander, Commander MAX, Maverick Trail, Maverick Sport, Maverick Sport MAX	<b>715003672</b>
	<ul style="list-style-type: none"> <li>Orchestrated for outstanding sound quality and the playlists of champions.</li> <li>Built-in 200 W amplifier with D-Bass Tech for improved low end bass response.</li> <li>Built-in Bluetooth<sup>®</sup> connectivity with source control.</li> <li>Aux input allows for use with non-Bluetooth devices.</li> </ul>	<ul style="list-style-type: none"> <li>Turns itself off after 10 minutes of inactivity to save battery power.</li> <li>Designed to be Can-Am-tough in the most demanding riding conditions.</li> <li>Includes 4.5" (11.4 cm) front and 6.5" (16.5 cm) rear-roll-cage mounted stereo speakers and console integrated backlit control panel.</li> </ul>

<b>Wetsound Stealth XT 6 Can-Am Edition Sound Bar</b>	Commander, Commander MAX, Maverick Trail, Maverick Sport, Maverick Sport MAX	<b>715008282</b>
	<ul style="list-style-type: none"> <li>Built-in Bluetooth connectivity with source control.</li> <li>Built-in Broadcast mode.</li> <li>Backlit control panel with integrated LED RGB cabin lights.</li> <li>Integrated LED Dome.</li> <li>IP67 rated RF wireless remote control.</li> <li>3.5 Aux Input/Output.</li> <li>Built-in 300 W Class D Amplifier.</li> </ul>	<ul style="list-style-type: none"> <li>4 marine-rated 3" full range drivers.</li> <li>2 marine-rated 1" tweeters.</li> <li>Operating voltage: 12 V.</li> <li>IP rated: IP67.</li> <li>Length: 21.31"</li> <li>Width: 4.04"</li> <li>Height: 3.85"</li> <li>Sound Bar Mounting Kit required for installation.</li> </ul>

<b>Sound Bar Mount Kit</b> <i>(Not illustrated)</i>	Commander, Commander MAX, Maverick Trail, Maverick Sport, Maverick Sport MAX	<b>715004745</b>
<ul style="list-style-type: none"> <li>Required mount kit for the Wet Sounds Stealth 6 Ultra HD Can-Am Edition Sound Bar (715008282).</li> </ul>		

<b>Can-Am Subwoofer</b>	Commander, Commander MAX, Maverick Trail, Maverick Sport, Maverick Sport MAX	<b>715006359</b>
	<ul style="list-style-type: none"> <li>Powerful Wet Sounds 8" Subwoofer speakerbox that fits in the glove box.</li> <li>Easy plug-and-play connections to Wet Sounds audio system.</li> <li>Sturdy construction, tough enough to withstand harsh environments and sealed against moisture and dirt.</li> <li>350 W amplifier and wiring included.</li> </ul>	





<b>Electronic Device Holder</b>	Commander, Commander MAX, Maverick Trail, Maverick Sport, Maverick Sport MAX	<b>715005212</b>
	<ul style="list-style-type: none"> <li>A great in-ride entertainment system platform.</li> <li>Robust injected-polypropylene construction allows for right fit and easy installation.</li> <li>Adjustable unit safely holds most tablets and smartphones measuring between 5.1" (13 cm) and 10" (25.4 cm) (with protective case).</li> <li>Allows the installation of Garmin Montana 680T GPS.</li> <li>Perfectly complements the Wet Sounds audio systems or Rugged Radios Intercom System to play music with your device.</li> <li>Integrated storage (2.5 gal (9.5 L) capacity) with access to the dash 12V outlet for device charging.</li> <li>Integrated mounting location for RAM mounts.</li> <li>Not compatible with Defrost, Heat and Ventilation System (715003678).</li> </ul>	

## Communication Systems

<b>Rugged Radios Helmet Headset Kit for Rear Passengers</b>	With Rugged Radios Intercom System	<b>715004380</b> · US ONLY
	<ul style="list-style-type: none"> <li>Additional 12' (3.7 m) cables and Helmet Speaker/Mic Kits to upgrade your 2-person intercom system to a 4-person system.</li> </ul> <p><i>†Power Cable (715003094) is required for installation on MAX models.</i></p>	

# ELECTRICAL & ELECTRONIC ACCESSORIES

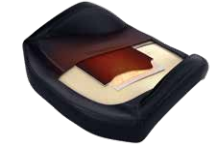
## Electrical

<b>Defrost, Heat and Ventilation System</b>	Commander, Commander MAX, Maverick Trail, Maverick Sport, Maverick Sport MAX	<b>715003678</b>
	<ul style="list-style-type: none"> <li>• Best integrated system on the market with 3 ventilation speeds and in-dash adjustable temperature.</li> <li>• Adjustable/directional vents.</li> <li>• 5 vents specially positioned for better windshield defrosting and passenger comfort.</li> <li>• Automotive-style heater core and fan for best heating performance.</li> <li>• Smart-Lok equipped vehicles require Adapter Kit (715007241).</li> <li>• Not compatible with the ProVent Windshield.</li> </ul>	
<b>Heated Steering Wheel</b>	Commander, Commander MAX, Maverick Trail, Maverick Sport, Maverick Sport MAX	<b>715004283</b>
	<ul style="list-style-type: none"> <li>• Ruggedly constructed steering wheel designed to withstand cold conditions while channeling heat directly to your hands.</li> <li>• Perfect for making hand mobility and grip readily available, e.g., hunting, manual farming.</li> <li>• Replaces stock steering wheel.</li> <li>• This kit includes the heated steering and in-dash switch.</li> <li>• Heated Accessories Wiring Harness (710005757) is required.</li> <li>• Draws a maximum of 45 W and 3.2 A at 13.5 W.</li> <li>• Not compliant with T-category</li> </ul>	
<b>Heated Grab Bar Cover</b>	Commander, Commander MAX, Maverick Trail, Maverick Sport, Maverick Sport MAX	<b>715004500</b>
	<ul style="list-style-type: none"> <li>• Made tough to hold up to the stresses of rough riding, this heated cover will keep your passenger's hands warm and securely gripped during long, cold outings.</li> <li>• Easy to install and remove.</li> <li>• This kit includes the heated grab bar cover and in-dash switch.</li> <li>• Heated Accessories Wiring Harness (710005757) is required.</li> <li>• Draws a maximum of 25 W and 1.8 A at 13.5 W.</li> </ul>	
<b>Seat Heater</b>	Commander, Commander MAX, Maverick Trail, Maverick Sport, Maverick Sport MAX	<b>715006112</b>
	<ul style="list-style-type: none"> <li>• 25 W seat heater delivers chill-free riding comfort.</li> <li>• High/low temperature settings allow you to control the desired degree of warmth.</li> <li>• This kit includes one carbon fiber seat heater, foam sheet and in-dash switch.</li> <li>• Installs directly in the original seat cushion.</li> <li>• Heated Accessories Wiring Harness (710005757) is required for front seat installation.</li> <li>• Heated Accessories Wiring Harness (715006004) is required for rear seat installation.</li> </ul>	
<b>Heated Visor Outlet</b>	Commander, Commander MAX, Maverick Trail, Maverick Sport, Maverick Sport MAX	<b>715001246</b>
	<ul style="list-style-type: none"> <li>• Strategically positioned on vehicle to maintain your agility.</li> <li>• Optional visor outlet that delivers fog-free riding.</li> <li>• Quick and easy installation.</li> <li>• Sold individually.</li> <li>• Heated Visor not included.</li> </ul>	
<b>Heated Accessories Wiring Harness</b>	Commander, Commander MAX, Maverick Trail, Maverick Sport, Maverick Sport MAX	<b>710005757</b>
<i>(Not illustrated)</i>	<ul style="list-style-type: none"> <li>• Electric harness required to hook up and operate front heated seats, heated steering wheel and heated grab bar.</li> </ul>	
<b>Heated Accessories Wiring Harness</b>	Commander MAX, Maverick Sport MAX	<b>715006004</b>
<i>(Not illustrated)</i>	<ul style="list-style-type: none"> <li>• Electric harness required to hook up and operate rear heated seats.</li> </ul>	
<b>Heater Adapter Kit for Smart-Lok</b>	Commander, Commander MAX, Maverick Trail, Maverick Sport, Maverick Sport MAX	<b>715007241</b>
<i>(Not illustrated)</i>	<ul style="list-style-type: none"> <li>• Adapter kit to fit heating system on Smart-Lok equipped vehicles.</li> </ul>	

## Electronic

### NEW Cellphone Holder

Commander, Commander MAX, Maverick Trail,  
Maverick Sport, Maverick Sport MAX

715008786



- Water resistant door allows for perfect phone positioning.
- Features capacitive and resistive touch screen technology.
- Spring system in back plate automatically adjusts for thickness.
- Fits all cellphones within 7.2" (185 mm) x 3.3" (85 mm) x 0.6" (15 mm) dimensions.
- Works with almost all charger wires.
- Does not include cellphone or charging wires.
- Requires the RAM GPS Mount (715003325) bolted directly on the dashboard for the Cellphone Holder to be supported. RAM GPS Mount (715003325) can also be installed on the Electronic Device Holder (715005212).

### RAM<sup>†</sup> GPS Mount

Commander, Commander MAX,  
Maverick Trail, Maverick Sport,  
Maverick Sport MAX

715003325



- Allows for GPS integration onto vehicle.
- Standard AMPS hole pattern for Garmin Cradle.

### Overhead Switch Panel

Commander, Commander MAX,  
Maverick Trail, Maverick Sport,  
Maverick Sport MAX

715003669



- Fully integrated Overhead Switch Panel gives additional switch spots for electrical accessories.
- Required for Can-Am lights installation on the roof and for other top-mounted electrical accessories.
- Optional for Baja Designs lights.
- Requires Sport Roof or Bimini Roof with Sun Visor for installation.

### 30 Ah Battery Holder

Commander, Commander MAX,  
Maverick Trail, Maverick Sport,  
Maverick Sport MAX

715004431



- Fixation plate designed to hold the 30 Ah Battery (515176151).
- 30 Ah Battery sold separately.

### C-TEK charger

860200997



- CTEK, the manufacturer of the smartest battery chargers in the world, has produced a BRP specific charger for all BRP products.
- Charger is built to meet the demanding arctic conditions.
- Ask your dealer for more information.

<b>Digitally Encoded Security System (D.E.S.S.) Keys</b>	Maverick Trail, Maverick Sport 2024 (except 700 engine)	<b>715002458</b>
--	---	------------------



- Top-security anti-theft protection for your vehicle.
- Encrypted chip technology restricts access to your vehicle's electronic ignition system.
- One vehicle/one code.
- A vibration/shock-resistant ball-and-socket design that ensures a reliable connection.
- 3 programmable modes:
  - Work mode: Limits vehicle speed to 40 kph (25 mph) but does not limit engine torque.
  - Normal mode: Limits vehicle speed to 70 kph (44 mph) and 50% torque reduction.
  - Performance mode: No restrictions.

<b>NEW Digitally Encoded Security System (D.E.S.S.™) Keys</b>	Maverick Trail 2024 (with 700 engine)	<b>715009300</b>
---	---------------------------------------	------------------



- Top-security anti-theft protection for Can-Am vehicles.
- The encrypted chip technology restricts access to the unit's electronic ignition system.
- One code per vehicle.
- Features a vibration/shock-resistant ball-and-socket design that ensures a reliable connection.
- Comes with three programmable keys, including:
  - Work key: Configurable vehicle speed limit between 30 kph (18 mph) and maximum vehicle speed that does not limit engine torque.
  - Normal key: Limits vehicle speed to 70 kph (44 mph) and 50% torque reduction on Maverick Trail models.
  - Performance key: No restrictions.

# WINCHES & HITCHES

## Can-Am HD Winches

<b>Can-Am HD 4500 Winch</b>	Commander, Commander MAX, Maverick Trail, Maverick Sport, Maverick Sport MAX	<b>715006416</b>
-----------------------------	--	------------------



- Ergonomic clutch handle.
- Rugged all-steel gears and bushings for more torque and durability.
- Automatic 100% load-holding brake.
- Sealed solenoid for all-weather protection.
- Weather sealed corded remote and dash mounted switch.
- EC compliant.
- Pulling strength capability of 4,500 lb (2,041 kg).
- 43' of 1<sup>9</sup>/<sub>64</sub>" (13.1 m of 6.3 mm) wire steel cable.
- Heavy-duty 4-way roller fairlead.
- Winch Electrical Harness (715003777) is required for installation.
- Commander X mr front bumper requires Winch Electrical Harness (715008218).

<b>Can-Am HD 4500-S Winch</b>	Commander, Commander MAX, Maverick Trail, Maverick Sport, Maverick Sport MAX	<b>715006417</b>
-------------------------------	--	------------------



- Ergonomic clutch handle.
- Rugged all-steel gears and bushings for more torque and durability.
- Automatic 100% load-holding brake.
- Sealed solenoid for all-weather protection.
- Weather sealed corded remote and dash mounted switch.
- Pulling strength capability of 4,500 lb (2,041 kg).
- 50' of 1/4" (15.2 m of 6.35 mm) synthetic rope.
- Corrosion-proof aluminum hawse fairlead.
- Winch Electrical Harness (715003777) is required for installation.
- Commander X mr front bumper requires Winch Electrical Harness (715008218).

## WARN† VRX Winches

<b>WARN VRX 45 Winch</b>	Commander, Commander MAX, Maverick Trail, Maverick Sport, Maverick Sport MAX	<b>715006110</b>
--------------------------	--	------------------





- Extreme IP68-rated waterproof sealing keeps the elements out.
- Durable all-metal construction.
- Black powder-coated finish and stainless steel fasteners for corrosion resistance.
- Robust new clutch design based on 70+ years of WARN 4 WD hub lock know-how.
- Load-holding brake for great control.
- Smooth and reliable all-metal three-stage planetary gear train.
- Dash-mounted rocker control.
- Limited lifetime warranty (mechanical), 3-year warranty (electrical).
- Pulling strength capability of 4,500 lb (2,041 kg).
- 50' of 1/4" (15 m of 6.3 mm) wire steel cable.
- Roller fairlead.
- Winch Electrical Harness (715003777) is required for installation.
- Commander X mr front bumper requires Winch Electrical Harness (715008218).





<b>WARN VRX 45-S Winch</b>	Commander, Commander MAX, Maverick Trail, Maverick Sport, Maverick Sport MAX	<b>715006111</b>
	<ul style="list-style-type: none"> <li>• Extreme IP68-rated waterproof sealing keeps the elements out.</li> <li>• Durable all-metal construction.</li> <li>• Black powder-coated finish and stainless steel fasteners for corrosion resistance.</li> <li>• Robust new clutch design based on 70+ years of WARN 4 WD hub lock know-how.</li> <li>• Load-holding brake for great control.</li> <li>• Smooth and reliable all-metal three-stage planetary gear train.</li> </ul>	<ul style="list-style-type: none"> <li>• Dash-mounted rocker control.</li> <li>• Limited lifetime warranty (mechanical), 3-year warranty (electrical).</li> <li>• Pulling strength capability of 4,500 lb (2,041 kg).</li> <li>• 50' of ¼" (15 m of 6.3 mm) synthetic rope.</li> <li>• Cast aluminum hawse fairlead.</li> <li>• Winch Electrical Harness (715003777) is required for installation.</li> <li>• Commander X mr front bumper requires Winch Electrical Harness (715008218).</li> </ul>

## Winch Accessories

<b>Can-Am HD Hawse Fairlead</b>	Can-Am HD Winch	<b>715006426</b>
	<ul style="list-style-type: none"> <li>• A must when upgrading your winch with a synthetic cable, this corrosion-proof aluminum hawse fairlead will prevent the cable from snapping in a corner of a roller fairlead and from wearing prematurely due to the rough surface of the worn roller guide.</li> <li>• Must be used with synthetic cables only.</li> </ul>	

<b>WARN Hawse Fairlead</b>	WARN Winch	<b>705204567</b>
	<ul style="list-style-type: none"> <li>• Double-powder-coated construction.</li> <li>• Required to use the Synthetic Winch Cable (715001118) on WARN winches.</li> <li>• To be used with synthetic winch cables only.</li> </ul>	

<b>Roller Fairlead</b>	Can-Am HD Winch	<b>715007082</b>
	<ul style="list-style-type: none"> <li>• Suggested when changing the wire rope.</li> <li>• Heavy-duty replacement fairlead for winches.</li> </ul>	

<b>Wire Rope Replacement</b>	Can-Am HD Winch	<b>705014978</b>
	<ul style="list-style-type: none"> <li>• 47' of ¼" (14.3 m of 6.3 mm) wire rope.</li> <li>• 4,500 lb (2,041 kg) pulling strength.</li> </ul>	

<b>Synthetic Winch Cable</b>	Can-Am HD Winch	<b>715006430</b>
	<ul style="list-style-type: none"> <li>• 50' of ¼" (15.2 m of 6.35 mm) synthetic cable for Can-Am HD winches.</li> <li>• Can-Am HD Hawse Fairlead (715006426) is required when upgrading to a synthetic cable to avoid premature cable damage and wear.</li> </ul>	

<b>Synthetic Winch Cable</b>	WARN winch	<b>715001118</b>
	<ul style="list-style-type: none"> <li>• 50' of 7/32" (15.2 m of 5.5 mm) synthetic cable for WARN winch.</li> <li>• WARN Hawse Fairlead (705204567) is required when upgrading to a synthetic cable to avoid damage and premature wear of the cable.</li> </ul>	

<b>Synthetic Cable Extension</b>	Commander, Commander MAX, Maverick Trail, Maverick Sport, Maverick Sport MAX	<b>715001120</b>
	<ul style="list-style-type: none"> <li>• Lightweight ¼" (6.35 mm) diameter, easy to handle and won't rattle in cargo box.</li> <li>• Easily attaches to winch cable to provide additional 50' (15.2 m) of distance.</li> <li>• 4,500 lb (2,041 kg) single line capacity.</li> </ul>	

## Wired Remote Control

Can-Am HD Winch

715006504 (2020 & up)



- This kit allows winch owners to add the hand-held remote to vehicles with a stock winch.
- OEM stock winch and Wired Remote Control are sold separately.
- EC compliant.

## Wireless Remote Control

WARN Winch

715002542



- The system is quick and easy to install, thanks to a wiring harness with an integrated antenna and all necessary mounting hardware.
- Allows you to operate your winch from anywhere within a 50' (15.2 m) radius, increasing your recovery options.
- All components are weatherproof.

## Hitches

### Front Receiver Hitch

Commander, Commander MAX,  
Maverick Trail, Maverick Sport,  
Maverick Sport MAX

715003642



- Heavy-duty 1,500 lb (680 kg) towing capacity 2" (5 cm) receiver hitch.
- Perfect for precision towing in small spaces.

### Front and Rear Hitch Drawbar

Commander, Commander MAX

715008350



- Standard on 2" (5 cm) receiver hitch.
- It offers 1,650 lb (750 kg) of towing capacity.
- Hitch ball not included.
- Forged steel.
- Not compliant with T-category

# PERFORMANCE

## Smart-Lok Technology

### Smart-Lok Differential

Maverick Trail, Maverick Sport,  
Maverick Sport MAX (2021 & prior)

705402936



- Can-Am-exclusive Smart-Lok technology constitutes a true fully lockable on-the-fly front differential with electronically controlled automatic modes.
- Choose your differential settings according to your riding need: "2x4" for rear wheel traction only, "4x4 Front Diff. Lock" for a fully locked 4 wheel drive, and "4x4 Smart Mode" that offers preset, intelligent calibrations for your type of riding.
- Using multiple input sources, "Smart Mode" will instantaneously engage locking with the right load at the right moment to procure maximum traction while retaining low-speed maneuverability, allowing for optimal placement and a feeling of confidence.
- The Smart-Lok Differential Kit comes standard with the Trail Mode.
- Mud, Rock and Trail Activ modes can be added by installing an additional Smart Mode Module (sold separately) to fine-tune your riding environment.
- Requires Performance Half Shafts (2x) and Smart-Lok Installation Kit for installation.

### Performance Half Shaft

Maverick Trail

705402423

Maverick Sport, Maverick Sport MAX

705402281



- High-performance design ideal for off-road use, with superior protection in any riding usage.
- Includes CVs, shaft and boots with the best suited geometry for your Can-Am vehicle.
- Required to install the Smart-Lok Differential Kit.

### Mud Smart Mode Module

(Not illustrated)

Models with Smart-Lok Differential

715005282

- This module allows you to add the Mud Smart Mode to vehicles with the Smart-Lok Differential Kit sold as an accessory or to change to the Mud Smart Mode on vehicles equipped with a standard Smart-Lok.
- The Mud Mode has been specially designed to deliver superior traction in the deepest mud holes.
- When high engine torque and/or slippage is detected, Smart-Lok will fully lock the front end.
- The system will stay locked until throttle release.
- Only one Smart Mode Module can be installed at a time.

### Rock Smart Mode Module

(Not illustrated)

Models with Smart-Lok Differential

715005283

- This module allows you to add the Rock Smart Mode to vehicles with the Smart-Lok Differential Kit sold as an accessory or to change to the Rock Smart Mode on vehicles equipped with a standard Smart-Lok.
- The Rock Mode has been specially designed to help cross challenging rocks.
- When high engine torque is detected at low vehicle speed, Smart-Lok will progressively lock the front end and will stay engaged until throttle release to prevent wheel slippage and provide optimal traction.
- The progressive engagement allows for easier steering when maneuvering the vehicle.
- Only one Smart Mode Module can be installed at a time.

### Trail Activ Smart Mode Module

(Not illustrated)

Models with Smart-Lok Differential

715005284

- This module allows you to add the Trail Activ Smart Mode to vehicles with the Smart-Lok Differential Kit sold as an accessory or to change to the Trail Activ Smart Mode on vehicles equipped with a standard Smart-Lok.
- The Trail Activ Mode has been designed for aggressive riding, delivering the ultimate cornering precision.
- When high engine torque and/or an increase in vehicle speed is detected, Smart-Lok will progressively engage the front end and keep it engaged until throttle release or vehicle speed reduction.
- The progressive engagement allows for smoother and lower steering effort.
- Only one Smart Mode Module can be installed at a time.

## Exhaust and Air Intake

### Yoshimura<sup>†</sup> Slip-On Exhaust



Maverick Sport, Maverick Sport MAX (models with 1000R engine)

715004452

- Developed in collaboration with Yoshimura.
- Made from 304-grade stainless steel.
- Sporty sound from a lighter-than-stock muffler.
- USDF/USDA approved spark arrester.
- EPA compliant.
- Not EC compliant.

### Performance Air Filter by Twin AIR<sup>†</sup>



Commander, Commander MAX, Maverick Trail, Maverick Sport, Maverick Sport MAX (models with 1000R engine)

715002895

Maverick Trail, Maverick Sport (except models with 1000R engine)

715003630

- The best choice for the harshest conditions.
- Multiple staged oiled filtering foam for superior dust retaining capacity with high airflow.
- Washable and reusable.

### Engine and CVT Pre-Filter Kit

(Not illustrated)

Commander, Commander MAX, Maverick Trail, Maverick Sport, Maverick Sport MAX

715004290

- Adds extra protection to your engine and CVT in harsh riding conditions.
- Filter blocks particles larger than 0.005" (0.1 mm).
- Water repellent screen.
- Mandatory to maintain the vehicle's warranty when tracks are installed.
- Recommended for winter riding conditions.
- Not compatible with Snorkel Kit.
- Not compatible with Adventure Roof Rack.

### Snorkel Pre-Filter



Commander, Commander MAX, Maverick Trail, Maverick Sport, Maverick Sport MAX

715005598

- Pre-filter specifically for snorkels.
- Adds extra protection to your engine in harsh riding conditions.
- Helps keep air filter cleaner.
- Filter blocks particles larger than 0.005" (0.13 mm).
- Mandatory to maintain vehicle warranty when tracks are installed.

<b>Snorkel Kit</b>	Commander, Commander MAX (except 700 engines), Maverick Trail (except 700 engines), Maverick Sport, Maverick Sport MAX	<b>715003705</b>
--------------------	--	------------------



- Raises point of engine and CVT air intakes so vehicle can be semi-submersed in water/mud without taking in water to the engine.
- Not compatible with S&B Particle Separator, LinQ Pivoting Rack, Lonestar Racing Rear Intrusion Bar and all rear panels and windows.
- Standard on Maverick Sport and Commander X mr models.
- Not compliant with T-category.

<b>Heavy-Duty Spring Kit</b>	Maverick Trail	<b>715004961</b>
------------------------------	----------------	------------------



- This set of heavy-duty springs will stiffen your suspension.
- Perfect for reducing vehicle overall sag when shocks are under heavy demand: heavy loading and hauling or for snow clearing.
- Complete kit of 4 springs.

<b>Shock Covers</b> <i>(Not illustrated)</i>	Maverick Sport, Maverick Sport MAX	<b>715002368</b>
---	------------------------------------	------------------

- Soft covers for shocks with ventilation holes.
- Eliminate dust and dirt intrusion into the shock cylinder, reducing risk of damage.
- Sold in pairs.

## Emergency Accessories

<b>Emergency Kit</b>	Commander, Commander MAX, Maverick Trail, Maverick Sport, Maverick Sport MAX	<b>715006102</b>
----------------------	--	------------------



- Complete emergency kit provides all essential equipment and supplies to get out of most unfavorable situations powersport enthusiasts can find themselves in.
- Includes: Jumper Cables, Air Compressor, Tire Repair Kit, Ratchet Tie-Down, Duct Tape, Tow Strap 3,300 lb (1,500 kg), Zip-Ties, Cloth Rags.

# APACHE TRACK SYSTEMS

## Winter Tracks Limited Warranty\*

<b>Apache Backcountry Track System</b>	See table for specific models	<b>715005247</b>
--	-------------------------------	------------------



- Designed to deliver the best flotation level and deep-snow performance on the market.
- Contact patch is 23% bigger than the Apache 360 LT.
- Provides an impressive average ground clearance increase of 7" (18 cm), keeps the vehicle out of deep snow.
- Aggressive track design with 2" (5 cm) lug height for maximum traction on snow.
- Apache Backcountry Mounting Kit, Track DPS Module and Engine and CVT Pre-Filter are required.
- For winter use only.
- Track installation will affect vehicle width and length.

*Installation of some accessories shown may impact vehicle compliance with some regulations. Consult your local dealer for information.*

<b>Apache Backcountry LT Track System</b>	See table for specific models	<b>715005891</b>
---	-------------------------------	------------------



- Tracks designed to deliver the best snow performance on the market with unmatched flotation level and traction on snow surface.
- Large contact patch, 37% bigger than the Apache 360 LT.
- Impressive added ground clearance of 7" (18 cm) helps keep the vehicle over the snow.
- Lightweight snowmobile-inspired rail design.
- Aggressive track design with 2" (5 cm) lug height for maximum traction on snow.
- Apache Backcountry LT Mounting Kit, Track DPS Module, Engine and CVT Pre-Filter are required.
- Fine-tune your track system using extra Idler Wheels, Sliders with Vespel Inserts and Rail Ice Scratcher.
- For winter use only.
- Track installation will affect vehicle width and length.

*Installation of some accessories shown may impact vehicle compliance with some regulations. Consult your local dealer for information.*

\*The limited warranty is subject to the exclusions, limitations of liabilities and all other terms and conditions of BRP's standard limited warranty.



### Apache Backcountry Mounting Kit

(Not illustrated)

See table for specific models

Maverick Trail

715004834

715004285

- Required for installation of the Apache Backcountry Track System.
- Not compatible with HMWPE Front and Rear A-Arm Protectors and Skid Plates.
- DPS Module and Pre-Filter not included.

Installation of some accessories shown may impact vehicle compliance with some regulations. Consult your local dealer for information.

### Apache Backcountry LT Mounting Kit

(Not illustrated)

See table for specific models

715005493

- Required for installation of the Apache Backcountry Track LT System.
- DPS Module and Pre-Filter are required and sold separately.
- Not compatible with HMWPE Front and Rear A-Arm Protectors and Skid Plates.

Installation of some accessories shown may impact vehicle compliance with some regulations. Consult your local dealer for information.

## Accessories

### Track DPS Module

(Not illustrated)

Commander, Commander MAX 2021 & up, Maverick Trail, Maverick Sport

715007338

- Innovative DPS module that ensures speedometer accuracy and optimized steering assist which make for perfect track control and riding ease.
- Required to install the Apache and Backcountry Track Systems.

Installation of some accessories shown may impact vehicle compliance with some regulations. Consult your local dealer for information.

### Rail Ice Scratchers



Apache Backcountry and Apache Backcountry LT track systems

860201728

- Provide additional lubrication in hard and icy conditions.
- Rail mounted, small, light.
- Design expands on coil concept to allow reversing without damage.
- Easily stored when not in use.
- Extend slider life.

## Year-Round Tracks

## Limited Warranty\*

### Apache 360 LT Track System

(Not illustrated)

Commander, Commander MAX, Maverick Trail, Maverick Sport, Maverick Sport MAX

715005103



- Multifunctional tracks designed to support heavy loads and to fit on most Can-Am off-road vehicles.
- Extra contact patch adjustment for better performance over rough terrain.
- Contact patch is 7 to 9% bigger than the Apache 360's.
- Average ground clearance of 16" (41 cm). 1" (2.5 cm) lugs in the front and 1.25" (3.2 cm) in the back.
- EC compliant.
- Apache Backcountry LT Mounting Kit, Track DPS Module, Engine and CVT Pre-Filter are required.

Installation of some accessories shown may impact vehicle compliance with some regulations. Consult your local dealer for information.

### Apache 360 LT Mounting Kit

(Not illustrated)

See table for specific models

Maverick Trail

715004755

715004833

- Required for installation of the Apache 360 LT Track System.
- DPS module and Pre-Filter not included.
- Not compatible with HMWPE Front and Rear A-Arm Protectors and Skid Plates.

Installation of some accessories shown may impact vehicle compliance with some regulations. Consult your local dealer for information.

### Apache 360 LT Mounting Kit

(Not illustrated)

See table for specific models

715005492

- Required for installation of the Apache 360 LT Track System.
- DPS module and Pre-Filter not included.
- Not compatible with HMWPE Front and Rear A-Arm Protectors and Skid Plates.

Installation of some accessories shown may impact vehicle compliance with some regulations. Consult your local dealer for information.

\*The limited warranty is subject to the exclusions, limitations of liabilities and all other terms and conditions of BRP's standard limited warranty.

## Accessories

### Idler Wheel Kit

Apache Backcountry Track System, rear tracks only

**860201230**  
141 mm



- Reduces drag and rolling resistance.
- Includes 2 wheels, brackets and hardware.
- Add up to 2 kits per rear track.
- Can extend slider life in hardened snow conditions.

### Apache Backcountry LT Wheel Kit

Apache Backcountry and Apache Backcountry LT Track Systems

**715006293**



- Additional wheel kit for Backcountry LT rear tracks.
- Reduces drag and rolling resistance in hard snow conditions or when transporting heavier loads.
- Extends slider life in hard snow conditions.
- Includes two wheels, cross shaft and mounting hardware per kit to service one track corner.
- Up to two kits per rear track can be installed.

### Sliders with Vespel<sup>†</sup> Inserts

Apache Backcountry and Apache Backcountry LT Track Systems

**503194815**



- Use DuPont Vespel inserts for less friction.
- Longer life.
- Can be cut to desired length.
- 8 needed per vehicle.
- Sold individually.

## APACHE TRACK SYSTEMS FITTING GUIDE

### Apache Backcountry and Backcountry LT

Model Year / Model	Track	Track Mount	Track DPS Module	Prefilter without Snorkel	Prefilter with Snorkel
2018 & Up Maverick Trail	<b>715005247</b>	<b>715004285</b>	<b>715007338</b>	<b>715004290</b> (except X mr)	<b>715005598</b>
2021 & Up Commander DPS & Commander XT 700 60"	<b>715005247</b> (Backcountry) (doesn't fit 64")	<b>715004834</b>			
2019 & Up Maverick Sport, Maverick Sport MAX (except X mr, X rc, X xc models) 60"					
2021 & Up Commander, Commander MAX (except Commander DPS & Commander XT 700) 64"	<b>715005891</b> (Backcountry LT) (doesn't fit 60")	<b>715005493</b>			
2019 & Up Maverick Sport X mr, X rc, X xc 64"					

### Apache 360 LT

Model Year / Model	Track	Track Mount	Track DPS Module	Prefilter without Snorkel	Prefilter with Snorkel
2018 & Up Maverick Trail 50"	<b>715005103</b>	<b>715004833</b>	<b>715007338</b>	<b>715004290</b>	<b>715005598</b>
2021 & Up Commander DPS & Commander XT 700 60"					
2019 & Up Maverick Sport, Maverick Sport MAX (except X mr, X rc, X xc models) 60"		<b>715004755</b>			
2021 & Up Commander, Commander MAX (except Commander DPS & Commander XT 700) 64"		<b>715005492</b>			
2019 & Up Maverick Sport X mr, X rc, X xc 64"					

# PROMOUNT PLOWS

## PROMOUNT PLOW KITS

### Reference Chart

	66" Black Steel	66" Yellow Steel	72" Black Steel	72" Yellow Steel	66" Flex2	72" Flex2
Plow Kit	715007775	715008174	715007777	715008173	715007774	715007776
Blade	715006337	715006338	715004474	715006021	715006265	715004485
Push Frame	715007752	715007752	715007752	715007752	715007752	715007752
Mounting Plate	715007742	715007742	715007742	715007742	715007742	715007742

### Can-Am ProMount Steel Plow Kits

#### Can-Am ProMount Steel 66" (168 cm) Plow Kit

Commander, Commander MAX, Maverick Trail, Maverick Sport, Maverick Sport MAX

■ 715007775 · Black  
■ 715008174 · Yellow

#### Can-Am ProMount Steel 72" (183 cm) Plow Kit

Commander, Commander MAX, Maverick Trail, Maverick Sport, Maverick Sport MAX

■ 715007777 · Black  
■ 715008173 · Yellow



- These kits include:
  - Can-Am ProMount Steel Blade
  - Push Frame with Quick-Attach System
  - Can-Am ProMount Mounting Plate

### Can-Am ProMount Steel Blades

#### Can-Am ProMount Steel 66" (168 cm) Blade

Fits ProMount Push Frame

■ 715006337 · Black  
■ 715006338 · Yellow



- Plow blade made from 12-gauge steel.
- Replaceable wear blade.
- Large pin designed for easy blade rotation to eliminate snow buildup at pivot point.
- Blade design provides best snow roll-off at any angle.
- Clears 60" (152 cm) when plow is fully angled.
- Blade height of 17" (43 cm).
- Compatible with Can-Am ProMount Blade accessories to further enhance plow versatility.
- Not compatible with S3 High Clearance Front A-Arm.

#### Can-Am ProMount Steel 72" (183 cm) Blade

Fits ProMount Push Frame

■ 715004474 · Black  
■ 715006021 · Yellow



- Plow blade made from 12-gauge steel.
- Replaceable wear blade.
- Large pin designed for easy blade rotation to eliminate snow buildup at pivot point.
- Blade design provides best snow roll-off at any angle.
- Clears 66" (168 cm) when plow is fully angled.
- Blade height of 17" (43 cm).
- Compatible with Can-Am ProMount Blade accessories to further enhance plow versatility.
- Not compatible with S3 High Clearance Front A-Arm.

## Can-Am ProMount Angle Plows

<b>Can-Am ProMount 66" (168 cm) Steel Oneway State Blade</b>	Fits ProMount Push Frame	<b>715007263</b>
<b>Can-Am ProMount 72" (183 cm) Steel Oneway State Blade</b>	Fits ProMount Push Frame	<b>715007264</b>



- Make the job easier with the right tools, clear long alleys and make the task easier by sending the snow further out of the way.
- Wing end of plow measures 26" (67 cm) high and tapers down to 16" (41 cm).
- One-way "winged" state plow designed to throw snow higher.
- Rubber Flap (715007299) designed to keep snow away from the driver is offered as accessory (sold separately).
- Can-Am branded.

## Can-Am ProMount Flex2 Plow Kit

<b>Can-Am ProMount Flex2 66" (168 cm) Plow Kit</b>	Commander, Commander MAX, Maverick Trail, Maverick Sport, Maverick Sport MAX	<b>715007774</b>
<b>Can-Am ProMount Flex2 72" (183 cm) Plow Kit</b>	Commander, Commander MAX, Maverick Trail, Maverick Sport, Maverick Sport MAX	<b>715007776</b>



- These kits include:
  - Can-Am ProMount Flex2 Blade
  - Push Frame with Quick-Attach System
  - Can-Am ProMount Mounting Plate

## Can-Am ProMount Flex2 Blades

<b>Can-Am ProMount Flex2 66" (168 cm) Blade</b>	Fits ProMount Push Frame	<b>715006265</b>
---	--------------------------	------------------



- Plow blade made of UHMWPE, flexible and impact absorbing material prevents damaging your plow when accidental impact occurs.
- Replaceable wear blade.
- Large pin designed for easy blade rotation to eliminate snow buildup at pivot point.
- Blade design provides best snow roll-off at any angle.
- Clears 60" (152 cm) when plow is fully angled.
- Blade height of 17" (43 cm).
- Compatible with Can-Am ProMount Blade accessories to further enhance plow versatility.

<b>Can-Am ProMount Flex2 72" (183 cm) Blade</b>	Fits ProMount Push Frame	<b>715004485</b>
---	--------------------------	------------------



- Plow blade made of UHMWPE, flexible and impact absorbing material prevents damaging your plow when accidental impact occurs.
- Replaceable wear blade.
- Large pin designed for easy blade rotation to eliminate snow buildup at pivot point.
- Blade design provides best snow roll-off at any angle.
- Clears 66" (168 cm) when plow is fully angled.
- Blade height of 17" (43 cm).
- Compatible with Can-Am ProMount Blade accessories to further enhance plow versatility.

## Can-Am ProMount Plow Accessories

<b>Can-Am ProMount Edge Markers</b>	Commander, Commander MAX, Maverick Trail, Maverick Sport, Maverick Sport MAX	<b>715004206</b>
-------------------------------------	--	------------------



- Help locate the edges of your plow.
- Height: 24" (60 cm).
- Sold in pairs.
- Recommended for Maverick Trail and Maverick Sport.
- Compatible with Can-Am ProMount Steel and Flex2 blades with or without Blade Extensions (except for the Can-Am ProMount Steel 54" (137 cm) Blades).

<b>Can-Am ProMount 66" (168 cm) Plastic Wear Blade</b>	Maverick Trail, Maverick Sport, Maverick Sport MAX	<b>715004482</b>
--	--	------------------

<b>Can-Am ProMount 72" (183 cm) Plastic Wear Blade</b>	Commander, Commander MAX, Maverick Trail, Maverick Sport, Maverick Sport MAX	<b>715004483</b>
--	--	------------------



- Ideal to prevent leaving marks on your driveway.
- Compatible with Can-Am ProMount 72" (183 cm) Blades.

<b>Can-Am ProMount Drift Cutters</b>	Commander, Commander MAX, Maverick Trail, Maverick Sport, Maverick Sport MAX	<b>715006258</b>
--------------------------------------	--	------------------



- Help keep snow in the plow.
- Dimensions: 17" x 13" (43.2 cm x 33 cm).
- Sold in pairs.
- Compatible with Can-Am ProMount Steel and Flex2 blades with or without Blade Extensions (except for the Can-Am ProMount Steel 54" (137 cm) Blades).

<b>Can-Am ProMount Blade Extensions</b>	Commander, Commander MAX, Maverick Trail, Maverick Sport, Maverick Sport MAX	<ul style="list-style-type: none"> <li>■ <b>715004205</b> · Black</li> <li>■ <b>715005319</b> · Yellow</li> </ul>
---	--	---



- These conveniently extend your Can-Am ProMount Blade.
- Add 3" (8 cm) each side.
- Compatible with Can-Am ProMount Blades (except for the Can-Am ProMount Steel 54" (137 cm) Blades).
- Longer Wear Blade can be installed to go over the extra length given by the extensions.

<b>Back Drag Blade</b> <i>(Not illustrated)</i>	ProMount Plows (60" and more)	<b>715007794</b>
--	-------------------------------	------------------

- ¼-in. thick steel swivel scraper.
- Lifts up when the vehicle is moving forward so as to not affect the scraping.
- Increased capacity to pull snow.
- More aggressive scraping in reverse mode.
- Lifts the scraper off the ground so that it scrapes evenly.
- Adjustable in length for compatibility with 60", 66" and 72" blades.
- Compatible with ProMount blades (Flex and Steel).

<b>Curved Wear Blade</b> <i>(Not illustrated)</i>	Commander, Commander MAX, Maverick Trail, Maverick Sport, Maverick Sport MAX	<ul style="list-style-type: none"> <li>■ <b>715007792</b> · 66" (168 cm)</li> <li>■ <b>715007793</b> · 72" (183 cm)</li> </ul>
--	--	--

- Wear blade designed with a folded back bottom lip.
- The increased surface allows for less digging while plowing uneven surfaces.
- Ideal for snow covered gravel, grass, paver stone and other soft surfaces.

## Can-Am Promount Custom Solutions

<b>Can-Am ProMount Push Frame with Quick-Attach System</b>	Commander, Commander MAX, Maverick Trail, Maverick Sport, Maverick Sport MAX	<b>715007752</b>
--	--	------------------



- Heavy-duty steel tubes designed to withstand the roughest use.
- Mid-mount carriage provides ultimate push strength and traction.
- Allows 16" (41 cm) of plow lift on ATVs and 14" (36 cm) on Maverick Trail.
- Features a self aligning quick-attach system, an easy foot release pedal and an ergonomic handle for plow angle adjustment.

<b>Can-Am ProMount Push Frame Extension</b>	Commander, Commander MAX, Maverick Trail, Maverick Sport, Maverick Sport MAX	<b>715006257</b>
---	--	------------------



- 12" (30 cm) push frame extension required when plow is installed with Apache Track systems.

<b>Plow Roller Fairlead</b>	Commander, Commander MAX, Maverick Trail, Maverick Sport, Maverick Sport MAX	<ul style="list-style-type: none"> <li>■ <b>715001223</b> · Cylindrical Roller Fairlead</li> </ul>
-----------------------------	--	--



- Larger diameter lower roller reduces wear on wire rope for plow application.
- Can be used with all ProMount plows.



<b>Can-Am ProMount Plow Angling System</b>	Commander, Commander MAX, Maverick Trail, Maverick Sport, Maverick Sport MAX	<b>715007801</b>
	<ul style="list-style-type: none"> <li>• Converts your plow system into an easy-to-control unit from the driver's seat.</li> <li>• Using one hand to control all plow motions will allow you to easily concentrate and manage your plowing tasks.</li> <li>• Not compatible with Apache Backcountry LT Track System.</li> <li>• Can-Am ProMount Push Frame (715007752) is required.</li> <li>• Push Frame Extension (715006257) is required for installation with the Front Rancher Bumper.</li> <li>• Winch and plow sold separately.</li> </ul>	

<b>ProMount Plow Limit Switch</b> <i>(Not illustrated)</i>	Commander, Commander MAX, Maverick Trail, Maverick Sport, Maverick Sport MAX	<b>715006259</b>
<ul style="list-style-type: none"> <li>• For controlling the cable tension when over-raising your plow system.</li> <li>• Prevents winch, plow push frame and vehicle damage.</li> <li>• Sensor relocated for optimal lift height.</li> </ul>		

<b>Can-Am ProMount Mounting Plate</b>	Commander, Commander MAX, Maverick Trail, Maverick Sport, Maverick Sport MAX	<b>715007742</b>
	<ul style="list-style-type: none"> <li>• Required to install the Can-Am ProMount Push Frame with Quick-Attach System.</li> <li>• Mounting plate precision-designed to stay on year round without compromising ground clearance.</li> <li>• Plow Roller Fairlead included.</li> </ul>	

# COVERS

<b>Trailer Cover</b>	Commander	<b>715006817</b>
	Commander MAX	<b>715007108</b>
	Maverick Trail, Maverick Sport	<b>715003706</b>
	<ul style="list-style-type: none"> <li>• Weather-resistant trailering cover protects your vehicle during storage and transportation.</li> <li>• Heavy-duty canvas made of UV-resistant solution-dyed polyester.</li> <li>• Inner soft liner protects windshield.</li> <li>• All high-abrasion areas are reinforced with a double canvas layer.</li> <li>• Opening for fuel cap.</li> <li>• Quick and easy installation.</li> <li>• Designed to perfectly fit your vehicle with or without Can-Am accessories except with Adventure Roof Rack and track kits.</li> </ul>	



---

# PARTS AND MAINTENANCE

---





---

# PARTS AND MAINTENANCE

---

Keep an Eye on These Parts	162
Genuine Parts	166
XPS Tires	170
Tires & Rims	171
Lubricant & Oil Change Kit	176
Maintenance Products	177

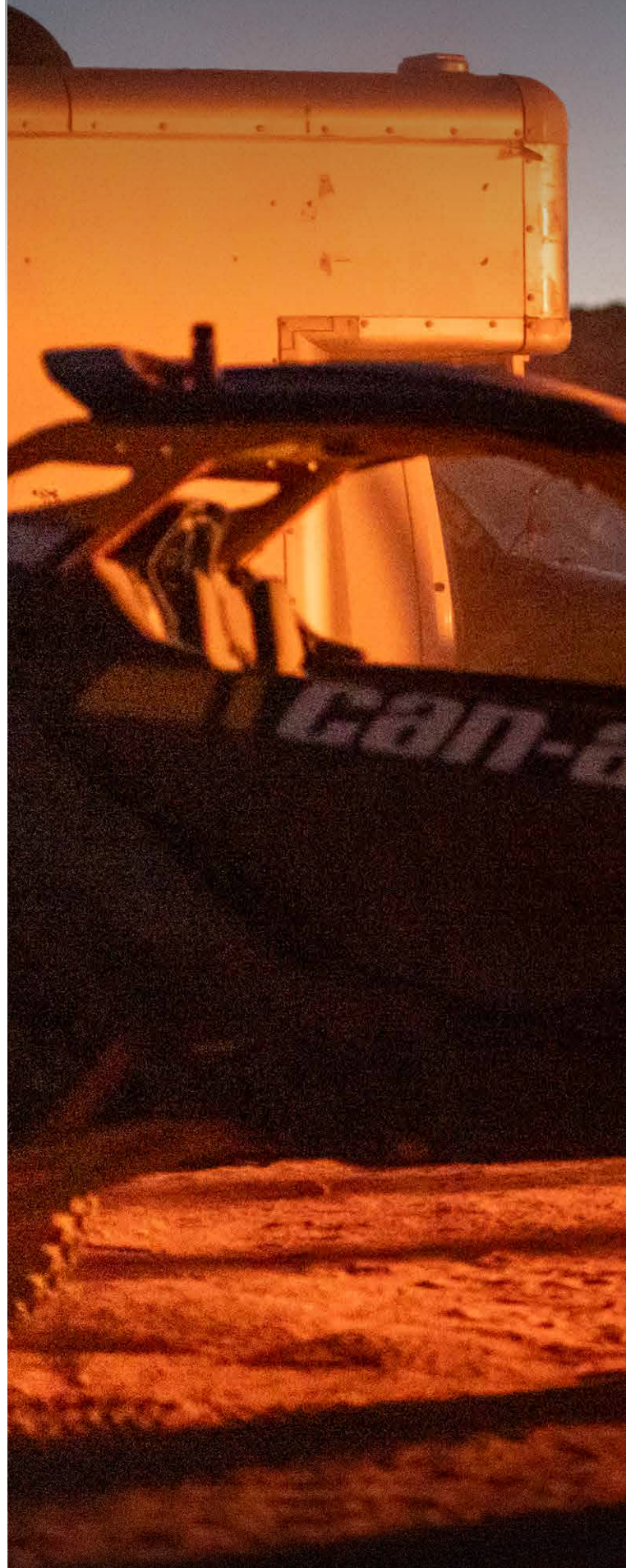



# BLENDING PERFORMANCE AND SAFETY

Trust genuine Can-Am  
parts to keep your vehicle  
performing at its best.

---

## TWO-YEAR WARRANTY\*

---

Precisely engineered. Rigorously tested. Factory approved.

\*Covers parts and labor when fitted at an authorised dealer.





To make sure your Traxter performs as you expect,  
**keep an eye on these components:\*\***

#### **OIL FILTER** 420256188

#### **ENGINE OIL\***

**4T 10W-50 Synthetic Oil**  
1 quart / 946 ml 9779234  
1 US gallon / 3.785 L 9779235

**4T 0W-40 Synthetic Oil**  
1 quart / 946 ml 9779139  
1 US gallon / 3.785 L 9779140

**4T 5W-40 Synthetic Blend Oil**  
1 quart / 946 ml 9779133  
1 US gallon / 3.785 L 9779134

#### **OIL CHANGE KIT\***

**5W-40 Synthetic Blend Oil**  
500 cc or more V-twin engine 9779258

**0W-40 Synthetic Oil**  
500 cc or more V-twin engine 9779259

**10W-50 Synthetic Oil**  
500 cc or more V-twin engine 9779252

**5W-40 Synthetic Blend Oil**  
450 cc or less 9779256

**0W-40 Synthetic Oil**  
450 cc or less 9779257

#### **FUEL FILTER**

Non-EVAP models 709001120

EVAP models 513034047

#### **AIR FILTER** 715900394

#### **CVT AIR FILTER**

**HD9, HD10** 420450400

#### **DRIVE BELT**

**HD10 Premium (Stock)** 422280652

**HD9 Premium (Stock)** 422280656

**HD7 Premium (Stock)** 422280225

**Performance (Upgrade):**  
see Reference Chart for upgrade

#### **METALLIC BRAKE PADS**

**Traxter, Traxter Max**  
Front Left 715900379  
Front Right 715900380

**Traxter HD8, HD10**  
Rear Left 715900381  
Rear Right 715900382

**Traxter HD5**  
Rear Right 715900387

**Traxter MAX HD8, HD10**  
Rear Left 715900386  
Rear Right 715900387

#### **CV BOOT KITS**

Front Wheel Side 705401345

Front Differential Side 705401355

Rear 705501864

#### **WHEEL BEARINGS** 293350150

#### **FRONT A-ARM BUSHING KIT** 703500875

#### **BALL JOINTS**

Upper 706202044

Lower 706202045

#### **SPARK PLUG**

**HD10** 715900244

**HD9** 715900642

**HD7** 715900785

**HD5** 715900352

#### **BATTERY**

18 Amps. Wet (YTX20L-BS) 296000444

\* For Europe, please check correspondent PNs on page 176

\*\*Refer to periodic maintenance chart for proper intervals.



# CAN-AM MAVERICK SPORT, MAVERICK TRAIL AND COMMANDER



To make sure your Maverick Sport, Trail or Commander performs as you expect, **keep an eye on these components:**\*\*

## **OIL FILTER** 420256188

### **ENGINE OIL\***

#### **4T 10W-50 Synthetic Oil**

1 quart / 946 ml 9779234  
1 US gallon / 3.785 L 9779235

#### **4T 0W-40 Synthetic Oil**

1 quart / 946 ml 9779139  
1 US gallon / 3.785 L 9779140

#### **4T 5W-40 Synthetic Blend Oil**

1 quart / 946 ml 9779133  
1 US gallon / 3.785 L 9779134

### **OIL CHANGE KIT\***

#### **5W-40 Synthetic Blend Oil**

500 cc or more V-twin engine 9779258

#### **0W-40 Synthetic Oil**

500 cc or more V-twin engine 9779259

#### **10W-50 Synthetic Oil**

500 cc or more V-twin engine 9779252

### **FUEL FILTER**

Non-EVAP models 709001120

EVAP models 513034047

## **AIR FILTER**

### **Performance Air Filter** by Twin Air†

715002895

### **Maverick Trail & Sport** (700 cc & 1000 cc)

715900394

### **Maverick Trail & Sport** (1000R)

715900422

### **Commander**

(700 cc & 1000 cc)

715900394

### **Commander 1000R**

715900422

### **CVT AIR FILTER**

Except X mr

706600417

### **DRIVE BELT**

#### **Maverick Trail 700**

422280225

#### **Maverick Trail / Sport 1000**

422280656

#### **Commander 700**

422280225

#### **Commander 2021+ 1000 cc**

422280656

### **Performance (Upgrade):**

see Reference Chart for upgrade

### **METALLIC BRAKE PADS**

Front Left

715900379

Rear Left

715900386

Front Right

715900380

Rear Right

715900387

## **CV BOOT KITS**

### **Maverick Sport, Commander (ABS, X xc, X mr, X rc models only)**

Front Wheel Side 705401354

### **Maverick Sport (no ABS),**

#### **Maverick Trail**

Front Wheel Side 705401345

Front Differential Side 705401355

Rear 705501864

### **WHEEL BEARINGS**

293350150

### **A-ARM BUSHING KIT**

703500875

### **BALL JOINTS**

Upper

706203084

Lower

706202045

### **SPARK PLUG**

715900637

#### **Maverick Trail 700**

715900785

#### **Maverick Trail & Sport 1000**

715900642

#### **Maverick Trail & Sport 1000R**

715900244

#### **Commander 700**

715900785

#### **Commander 1000R**

715900244

### **BATTERY**

18 Amps. Wet (YTX20L-BS)

296000444

30 AH Battery Upgrade

515176151

\* For Europe, please check correspondent PNs on page 176

\*\*Refer to periodic maintenance chart for proper intervals.

# CAN-AM MAVERICK



To make sure your Maverick performs as you expect,  
**keep an eye on these components:\*\***

## **OIL FILTER** 420956123

### **ENGINE OIL\***

#### **4T 10W-50 Synthetic Oil**

1 quart / 946 ml 9779234  
1 US gallon / 3.785 L 9779235

#### **4T 0W-40 Synthetic Oil**

1 quart / 946 ml 9779139  
1 US gallon / 3.785 L 9779140

#### **4t 5w-40 Synthetic Blend Oil**

1 quart / 946 ml 9779133  
1 US gallon / 3.785 L 9779134

### **OIL CHANGE KIT\***

**5W-40 Synthetic Blend Oil**  
900 ACE 9779260

**10W-50 Synthetic Oil**  
900 ACE 9779261

### **FUEL FILTER**

Non-EVAP models 709001120

EVAP models 513034047

## **AIR FILTER**

**Performance Air Filter**  
by Twin Air<sup>1</sup> 715002895

**Premium Air Filter** 715900422

**CVT AIR FILTER** 420450405

**DRIVE BELT** 422280652

### **METALLIC BRAKE PADS**

Front Left 715900379

Rear Left 715900386

Front Right 715900380

Rear Right 715900387

## **CV BOOT KITS**

Rear Wheel & Differential Side 715900450

Front Wheel & Differential Side 705401354

**WHEEL BEARINGS** 293350151

### **BALL JOINTS**

Upper 706203084

Lower 706202045

**SPARK PLUG** 415130363

### **BATTERY**

18 Amps. Wet (YTX20L-BS) 296000444

\* For Europe, please check correspondent PNs on page 176

\*\*Refer to periodic maintenance chart for proper intervals.



# CAN-AM MAVERICK R



To make sure your Maverick R performs as you expect,  
**keep an eye on these components:\*\***

## **OIL FILTER** 420956747

### **ENGINE OIL\***

#### **4T 10W-50 Synthetic Oil**

1 quart / 946 ml 9779234  
1 US gallon / 3.785 L 9779235

#### **4T 0W-40 Synthetic Oil**

1 quart / 946 ml 9779139  
1 US gallon / 3.785 L 9779140

#### **4t 5w-40 Synthetic Blend Oil**

1 quart / 946 ml 9779133  
1 US gallon / 3.785 L 9779134

### **DCT OIL\***

1 quart / 946 ml 9779710

### **FUEL FILTER**

Non-EVAP models 709001120

EVAP models 709000529

## **AIR FILTER**

**Performance Air Filter**  
by Twin Air<sup>1</sup> 715002895

**Premium Air Filter** 715900422

## **METALLIC BRAKE PADS**

Front 705601795

Rear 705601797

## **CV BOOT KITS**

Rear Wheel & Differential Side 715900929

Front Wheel & Differential Side 715900450

## **WHEEL BEARINGS**

Front 705402652

Rear 705503036

## **BALL JOINTS**

Upper 706203084

Lower 706202045

## **SPARK PLUG**

715900935

## **BATTERY**

18 Amps. Wet (YTX20L-BS) 296000444

\* For Europe, please check correspondent PNs on page 176

\*\*Refer to periodic maintenance chart for proper intervals.

# GENUINE PARTS

## Oil Filters

Oil Filters	Models	Oil Filter	Sealing Ring (Oil Filter Cover)	Sealing Ring (Drain Plug)
	Traxter/Traxter MAX HD10, HD9	<b>420256188</b>	<b>420230923</b>	<b>420552280</b>
	Traxter/Traxter MAX HD7	<b>420256188</b>	<b>420230922</b>	<b>420552280</b>
	Maverick	<b>420956123</b>	<b>420230923</b>	<b>420552280</b>
	Maverick R	<b>420956747</b>	<b>420230922</b>	<b>420552280</b>
	Maverick Trail & Sport	<b>420256188</b>	<b>420230923</b>	<b>420552280</b>
	Commander	<b>420256188</b>	<b>420230922</b>	<b>420552280</b>

Complete Engine Oil Change Kit also available — see page 176

## Air Filters

Premium Air Filter	<ul style="list-style-type: none"> <li>• Premium quality filter.</li> <li>• Prevents airborne contaminants from reaching your engine.</li> <li>• Protects internal components against premature wear.</li> </ul>
--------------------	--

	Models	
	Traxter/Traxter MAX	<b>715900394</b>
	Maverick, Maverick R	<b>715900422</b>
	Maverick Trail & Sport (Engines 700 & 1000)	<b>715900394</b>
	Maverick Trail & Sport (Engine 1000R)	<b>715900422</b>
	Commander (Engines 700 & 1000R)	<b>715900394</b>
	Commander (Engine 1000R)	<b>715900422</b>

Performance Air Filter by Twin Air†	<ul style="list-style-type: none"> <li>• The best choice for the harshest conditions.</li> <li>• Multiple staged oiled filtering foam for superior dust retaining capacity with high air flow.</li> <li>• Washable and reusable.</li> </ul>
-------------------------------------	---

	Models	
	Maverick, Maverick R	<b>715002895</b>
	Maverick Trail & Sport	<b>715002895</b>

CVT Air Filter <i>(Not illustrated)</i>	Models	
	Traxter/Traxter MAX (except X mr)	<b>706600419</b>
	Maverick	<b>706600416</b>
	Maverick Trail & Sport (except X mr)	<b>706600417</b>
	Maverick Trail & Sport X mr	<b>706600418</b>
	Commander (2018 & Up)	<b>706600417</b>



## Spark Plug

Spark Plug	Models	
	Traxter HD10	715900244
	Traxter HD9	715900642
	Traxter HD7	715900785
	Maverick and Maverick Turbo RR	415130363
	Maverick R	715900935
	Maverick Trail & Sport 1000R	715900244
	Maverick Trail & Sport 1000	715900642
	Maverick Trail 700	715900785
	Commander 700	715900785
	Commander 1000R	715900244

## Batteries

### Yuasa† Batteries

• Top of the line models from the leading preferred original equipment battery supplier in North America.



Models	18 A Wet (YT20L-BS)	30 A, Requires Battery Holder (71504431)
Traxter/Traxter MAX	296000444	515176151 Except Base and DPS models.
Maverick, Maverick R	296000444	—
Maverick Trail & Sport	296000444	—
Commander	296000444	—

## Axles

### Premium CV Axles

• Premium quality design ideal for off-roading, heavy-duty and low speed torque usage.  
• Includes CVs, shaft and boots with the best suited geometry for your Can-Am vehicle.



Models	Front Left	Front Right	Rear
Traxter MAX	705401937	705401936	705502451
Traxter XT-P	705402353	705402353	705502451
Traxter HD10	705401937	705401936	705502451
Traxter HD9	705401937	705401936	705502451
Traxter HD7	705402749	705402750	705503100
Maverick R	705402490	705402490	705502907
Maverick Sport (ABS)	705402443	705402443	705502756
Maverick Sport Base, DPS	705402031	705402030	705502552
Maverick Trail (W/O ABS)	705402008	705402007	705502541
Maverick Trail (ABS)	705402442	705402442	705502755
Commander	705401871	705401872	705502411

### Performance CV Axles

(Not illustrated)

• High-performance design ideal for off-road use with superior wheel power and acceleration for racing, dunes, trails and desert riding.  
• Includes CVs, shaft and boots with the best suited geometry for your Can-Am vehicle.

Models	Front Left	Front Right	Rear
Traxter X mr	705402420	705402420	—
Maverick Sport X mr/X rc	705402282	705402282	705502757

## Brakes

### Metallic Brake Pad Kit



- Built strong to last long – heavy-duty construction stands up to hard braking.
- Designed to handle demanding riding conditions with challenging braking environments such as mud and dunes.
- Created specifically for use with Can-Am vehicles.

Models	Front Left	Front Right	Rear Left	Rear Right
Traxter MAX HD9/HD10	<b>715900379</b>	<b>715900380</b>	<b>715900386</b>	<b>715900387</b>
Traxter HD10	<b>715900379</b>	<b>715900380</b>	<b>715900381</b>	<b>715900382</b>
Traxter HD9	<b>715900379</b>	<b>715900380</b>	<b>715900381</b>	<b>715900382</b>
Traxter HD7	<b>715900379</b>	<b>715900380</b>	—	<b>715900387</b>
Maverick	<b>715900379</b>	<b>715900380</b>	<b>715900386</b>	<b>715900387</b>
Maverick R	<b>705601795</b>	<b>705601795</b>	<b>705601797</b>	<b>705601797</b>
Maverick Trail & Sport	<b>715900379</b>	<b>715900380</b>	<b>715900386</b>	<b>715900387</b>
Commander	<b>715900379</b>	<b>715900380</b>	<b>715900386</b>	<b>715900387</b>

Please contact your dealer or visit our online store at [Can-Amoffroad.com](http://Can-Amoffroad.com) for suggested fitment.

## Parts

### A-Arm Bushing Kit

**703500875**



- This bushing kit includes 2 bushings, a sleeve and a wear plate, as illustrated.
- All you need to renew your suspension A-Arms.

### Ball Joints

Upper

**706202044**

Upper (Maverick, Maverick R,  
Trail & Sport, Commander)

**706203084**

Lower

**706202045**

- Robust design for off-road usage and sealed for prolonged durability.



### Wheel Bearings

(Not illustrated)

2020 models and prior

**293350118**

2021 & up models

**293350126**

Maverick

**293350151**

Maverick R

**705402652** · Front  
**705503036** · Rear

- Sealed bearings for additional protection from water and dirt.

## CV Boot Kit

- Comes with clamps and grease.
- Genuine BRP CV Boot Kits ensure absolute compatibility and a perfect fit.

Models	Front Wheel Side	Front Differential Side	Rear Wheel & Differential Side
Traxter	705401345	705401355	705501864
Maverick	705401354	705401354	715900450
Maverick R	715900450	715900450	715900929
Maverick Sport (ABS, X xc, X mr, X rc)	705401354	705401355	705501864
Maverick Sport (w/o ABS), Maverick Trail	705401345	705401355	705501864
X mr	705401354	705401355	705501864
Commander	705401345	705401355	705501864



## Belts

### BRP Premium Drive Belt

- High-performance design ideal for off-road use.
- BRP-specific calibration adjusted to best suit your Can-Am vehicle.

Models	Premium Belt	CVT Gasket Cover	Upgrades
Traxter HD10	422280652	420450400	—
Traxter HD9	422280656	420450400	422280652
Traxter HD7	422280225	—	—
Maverick	422280652	420450405	—
Maverick Trail & Maverick Sport 1000	422280656	420450400	422280652
Maverick Trail 700	422280225	—	—
Commander 2020 & prior	422280366	420450126	—
Commander 2021 & Up 1000 CC	422280656	420450400	422280652
Commander 700	422280225	—	—



### Driven Pulley Adapter Tool

(Not illustrated)

- Spreads the secondary clutch open for easy belt replacement.

### Clutch Spreader Tool

(Not illustrated)

- Allows you to spread the secondary clutch open for easy belt replacement.

Models	Driven Pulley Adapter	Spreader Tool
Traxter HD10-HD9	708200720	529000088
Traxter HD7	—	529036098
Maverick Trail & Sport	708200720	529000088
Maverick	708200720	529000088
Commander	—	529036352

## pDrive Pulley Service Kits

### Ramp Roller Maintenance Set

All SxS pDrive

420629237

pDrive Ramp Roller Set



### Torque Roller Maintenance Set

All SxS pDrive

420629224

pDrive Torque Roller Set



# XPS TIRES

## SHOP BY USAGE



GRAVEL &  
HARD PACK



ROCK



MUD

### XPS Trail Force



- All-terrain radial tire.
- 8-ply rated construction.
- Versatile and suitable for many types of terrain.
- Aggressive tread pattern for better traction on dirt, mud and rocky terrains.
- Tread depth: 20 mm (0.78").

**705402754** - 27X9R14

**705503103** - 27X11R14

**705403026** - 26X8R14

**705503322** - 26X10R14

### XPS Trail King



- All-terrain radial tire.
- 8-ply rated construction.
- Aggressive tread pattern for tougher terrains.
- An almost continuous center tread offers a smoother trail ride.
- Tread depth: 26 mm (1.02").

**705402825** - 28X9R14

**705403081** - 27X9R14

**705503181** - 28X11R14

**705503355** - 27X11R14

**705402713** - 26X8R12

**705503073** - 26X10R12

### XPS Trac Force



- All-terrain light truck style radial tire.
- 8-ply rated construction.
- Central tread for good grip and comfort on compact terrain.
- Tread depth: 18 mm (0.71").

**705403080** - 30X9R14

**705503354** - 30X10R14

**705403416** - 32X10R16

### XPS Hammer Force



- Light truck-inspired tire.
- 8-ply rated construction.
- Rock-crawling tread pattern with unique contact patch.
- Aggressive sidewall for maximum traction when faced with technical terrains.
- Tread depth: 15 mm (0.59").

**705402918** - 30X10R15

### XPS Swamp Force



- Hybrid radial tire for mud & trail.
- 8-ply rated construction.
- Unique tread pattern allowing good grip in mud and mud ejection.
- Center tread provides for comfortable trail riding.
- Tread depth: 36-38 mm (1.41"-1.49").

**705403201** - 30X9R14

**705503387** - 30X11R14

### XPS Swamp King



- Bias tires for mud and trail.
- 6-ply rated construction.
- Ultimate performance in mud without sacrificing good trail handling.
- Tread depth: 38 mm (1.49").



**705403028** - 28X8X14

**705503324** - 28X10X14



# TRAXTER TIRES & RIMS

## Tires

<b>ITP Cryptid</b>		Traxter X mr	<b>705402504</b> · Front <b>705502913</b> · Rear
	<ul style="list-style-type: none"> <li>• Front: 30" x 9" x 14".</li> <li>• Rear: 30" x 11" x 14".</li> </ul>	<ul style="list-style-type: none"> <li>• Graduated lug height and paddle-like shoulder configuration provide maximum side bite for climbing in and out of the mud without compromising ride comfort on trails and hard pack.</li> <li>• 6-ply rated.</li> </ul>	
<b>Maxxis Bighorn 2.0 Tire</b>			
	<ul style="list-style-type: none"> <li>• Front: 27" x 9" x 14".</li> <li>• Rear: 27" x 11" x 14".</li> </ul>	Traxter (XT, XT Cab)	<b>705402168</b> · Front <b>705400961</b> · (C€)
	<ul style="list-style-type: none"> <li>• Front: 27" x 9" x 12".</li> <li>• Rear: 27" x 11" x 12".</li> </ul>	Traxter	<b>705502665</b> · Rear <b>705501295</b> · (C€)
	<ul style="list-style-type: none"> <li>• Front: 28" x 9" x 14".</li> <li>• Rear: 28" x 11" x 14".</li> </ul>	Traxter	<b>705402560</b> · Front <b>705401386</b> · (C€) <b>705502938</b> · Rear <b>705501818</b> · (C€)
<b>Maxxis M923J/M924J</b>		Traxter (Base & DPS models only)	<b>705402107</b> · Front <b>705502626</b> · Rear
	<ul style="list-style-type: none"> <li>• Front: 25" x 8" x 12".</li> <li>• Rear: 25" x 10" x 12".</li> </ul>		

<b>Rear Tire Chains</b>		<b>715000225</b> · 29" x 9"x 14"
	<ul style="list-style-type: none"> <li>• Improve your traction in mud and snow.</li> <li>• Sold in pairs.</li> </ul>	

## Rims

<b>14" Rim</b> <i>(Not illustrated)</i>		Traxter, Traxter MAX	<b>705401594</b> · Front <b>705503191</b> · Rear
	<ul style="list-style-type: none"> <li>• Front: 14" x 6.5" offset = 41 mm.</li> <li>• Rear: 14" x 8" offset = 51 mm.</li> </ul>	<ul style="list-style-type: none"> <li>• Black with clear coat aluminum rim.</li> <li>• Choice of beadlock color (not included).</li> <li>• Needs 16 bolts (250000787) for installing the beadlock.</li> </ul>	
<b>14" Beadlock Rings</b>		Traxter, Traxter MAX	<ul style="list-style-type: none"> <li>■ <b>705401586</b> · Manta Green</li> <li>■ <b>705401702</b> · Octane Blue</li> <li>■ <b>705401837</b> · Can-Am Red</li> <li>■ <b>705401840</b> · Black</li> </ul>
	<ul style="list-style-type: none"> <li>• Cast aluminum beadlock.</li> <li>• Must be installed on Front Rim (705401594) and Rear Rim (705503191).</li> </ul> <p><i>Matching Nuts - 250100184</i> <i>Matching Cap - 705400928</i></p>		

<b>12" Rim</b> <small>(Not illustrated)</small>	Traxter, Traxter MAX	<ul style="list-style-type: none"> <li>■ <b>705401678</b> · Black · Front</li> <li>■ <b>705502244</b> · Black · Rear</li> </ul>
<ul style="list-style-type: none"> <li>• Front: 12" x 6" offset = 41 mm.</li> <li>• Rear: 12" x 7.5" offset = 51 mm.</li> <li>• Black with clear coat aluminum rim.</li> <li>• Choice of beadlock color (not included).</li> <li>• Needs 16 bolts (250000787) for installing the beadlock.</li> </ul>		

<b>12" Beadlock Rings</b>	Traxter, Traxter MAX	<ul style="list-style-type: none"> <li>■ <b>705401816</b> · Can-Am Red</li> <li>■ <b>705401815</b> · Orange Crush</li> <li>■ <b>705401814</b> · Yellow</li> </ul>
	<ul style="list-style-type: none"> <li>• Cast aluminum beadlock.</li> <li>• Must be installed on Front Rim (705401678) and Rear Rim (705502244).</li> </ul> <p><i>Matching Nuts - 250100184</i>  <i>Matching Cap - 705400928</i></p>	

<b>Outlander X mr and Traxter Rim</b>	Traxter, Traxter MAX (front wheels)	<ul style="list-style-type: none"> <li>■ <b>705401848</b> · Black and machined · Front</li> <li>■ <b>705502397</b> · Black and machined · Front</li> <li>■ <b>705401849</b> · Black · Front</li> <li>■ <b>705502398</b> · Black · Rear</li> </ul>
	<ul style="list-style-type: none"> <li>• Cast aluminum rim with trendsetting explosive styling so you can ride—and look—like a trailblazer.</li> <li>• Front: 14" x 6.5" offset = 10 mm.</li> <li>• Rear: 14" x 8.5" offset = 23 mm.</li> </ul> <p><i>Matching Nuts - 250100184 Black, 250100185 Chrome</i>  <i>Matching Cap - 705401541</i></p>	

<b>Traxter Cast-Aluminum 14" Rim</b>	Traxter, Traxter MAX	<ul style="list-style-type: none"> <li>■ <b>705402338</b> · Black · Front</li> <li>■ <b>705502778</b> · Black · Rear</li> </ul>
	<ul style="list-style-type: none"> <li>• Front: 14" x 7" offset = 41 mm.</li> <li>• Rear: 14" x 8.5" offset = 51 mm.</li> </ul> <p><i>Matching Nuts - 250100184</i>  <i>Matching Cap - 705401541</i></p>	

<b>Lone Star Cast-Aluminum 14" Rim</b> <small>(Not illustrated)</small>	Traxter, Traxter MAX	<ul style="list-style-type: none"> <li>■ <b>705402334</b> · Front</li> <li>■ <b>705502775</b> · Rear</li> </ul>
<ul style="list-style-type: none"> <li>• Front: 14" x 7" offset = 41 mm.</li> <li>• Rear: 14" x 8.5" offset = 51 mm.</li> </ul> <p><i>Matching Nuts - 250100184</i>  <i>Matching Cap - 705401541</i></p>		

<b>Traxter Rim</b> <small>(Not illustrated)</small>	<ul style="list-style-type: none"> <li>■ <b>705402120</b> · Black · Front</li> <li>■ <b>705502637</b> · Black · Rear</li> <li>■ <b>705402118</b> · Silver and Machined · Front</li> <li>■ <b>705502634</b> · Silver and Machined · Rear</li> <li>■ <b>705402121</b> · Black and Machined · Front</li> <li>■ <b>705502635</b> · Black and Machined · Rear</li> </ul>
<ul style="list-style-type: none"> <li>• Front: 14" x 7" offset = 41 mm.</li> <li>• Rear: 14" x 8.5" offset = 51 mm.</li> </ul> <p><i>Matching Nuts - 250100184 Black, 250100185 Chrome</i>  <i>Matching Cap - 705401541</i></p>	

# COMMANDER, MAVERICK TRAIL & MAVERICK SPORT TIRES & RIMS

## Tires – Commander

### Maxxis Coronado Tire

Commander, Commander MAX<sup>†</sup>

705402058 · Front

705502576 · Rear



- Front: 27" x 9" x 14".
- Rear: 27" x 11" x 14".
- Compliant with European class T regulations.

<sup>†</sup>Except XT-P.

## Tires - Maverick Trail & Maverick Sport

### Maxxis Bighorn 2.0 Tire

Maverick Sport, Maverick Sport MAX

705402560 · Front

705502938 · Rear



- Front · 27" x 9" x 12".
- Rear · 27" x 11" x 12".
- Compliant with European class T regulations.

### Maxxis Liberty Tire

Maverick Sport X rc

705402563 · Front

705402143 · Rear



- Engineered for performance driving and to give you and your side-by-side freedom in a variety of terrains.
- Exceeds DOT test standards.
- 8-ply radial construction.
- Specialized rubber compound for supreme traction and control.
- Excellent tread wear.
- Front: 28" x 10" x 14".
- Rear: 30" x 10" x 14".

### Carlisle ACT Tire

Maverick Trail

705402313 · Front

705402314 · Rear



- Front · 26" x 8" x 12".
- Rear · 26" x 9" x 12".

## Rims

### 12" Maverick Trail DPS/Sport Rim

Maverick Trail DPS, Maverick Sport

Maverick Sport

Maverick Trail DPS

705401417 · Front

705501853 · Rear

705401417 · Rear



- Matching Nuts: 250100184 (Black).
- Matching Cap: 705400928.
- Maverick Sport: Front · 12" x 6" Offset = 41 mm/Rear · 12" x 7.5" Offset = 51 mm.
- Maverick Trail DPS: Front · 12" x 6" Offset = 41 mm/Rear · 12" x 6" Offset = 41 mm.

<b>14" Maverick Sport X rc/X mr Rim</b>	Maverick Sport X rc/X mr	<b>705402338</b> · Front
	Maverick Sport X rc	<b>705402338</b> · Rear
	Maverick Sport X mr	<b>705502778</b> · Rear



- Maverick Sport X rc: Front · 14" x 7" Offset = 41 mm/Rear · 14" x 7" Offset = 41 mm.
- Maverick Sport X mr: Front · 14" x 7" Offset = 41 mm/Rear · 14" x 8.5" Offset = 51 mm.

<b>12" Maverick Trail Rim</b>	Maverick Trail	<b>705401217</b>
-------------------------------	----------------	------------------



- Matching Nuts: 250100042.
- 12" x 6" – Offset = 41 mm.

# MAVERICK TIRES & RIMS

## Tires

<b>Maxxis<sup>†</sup> Bighorn 2.0 Tire</b>		<b>705402080</b> · Front
		<b>705502603</b> · Rear
		<b>705402168</b> · Front · (C€)
		<b>705502665</b> · Rear · (C€)



- Front · 28" x 9" x 14".
  - Rear · 28" x 11" x 14".
- Compliant with European class T regulations.
- Front · 27" x 9" x 14".
  - Rear · 27" x 11" x 14".

<b>Maxxis Liberty Tire</b>	Maverick X rc	<b>705402143</b> · Front
		<b>705402464</b> · Rear



- Engineered for performance driving and to give you and your side-by-side freedom in a variety of terrains.
- 8-ply radial construction.
- Front: 30" x 10" x 14".
- Rear: 32" x 10" x 15".

<b>Maxxis Carnivore Tire</b>	Maverick (except X mr, X rc & X rs models)	<b>705402960</b> · 30"
		<b>705402961</b> · 32"



- The Carnivore boasts a gnarly tread design that delivers excellent traction on rocks, roots, desert terrain, and mud. The Carnivore is designed to conquer a wide variety of terrains.
- Aggressive all-terrain tread pattern.
- 8-ply-rated radial construction.
- Front & Rear · 30" or 32" x 10" x 14".

<b>Maxxis Bighorn X ds Tire</b> <i>(Not illustrated)</i>		<b>705402081</b> · Front
		<b>705502604</b> · Rear

- Front · 29" x 9" x 14".
- Rear · 29" x 11" x 14".

<b>Maxxis Bighorn X rs Tire</b> <i>(Not illustrated)</i>		<b>705402082</b>
---	--	------------------

- Front & Rear · 30" x 10" x 14".



## Rims

### 14" Maverick X mr Rim

Maverick, Maverick MAX

**705402256**



- Black with clear coat aluminum rim.

### 14" Maverick Beadlock Rim

Maverick, Maverick MAX

■ **705402207**  
• Black and machined  
■ **705402173** · Black



- Black aluminum rim with machined face and clear coat.
- Choice of beadlock color (not included).
- Needs 16 bolts (250000893) for installing the beadlock.

### 14" Maverick Rim

Maverick, Maverick MAX

**705401965** · Front  
**705502493** · Rear



- Black with clear coat aluminum rim.
- Front: 14" x 7" Offset = 55 mm.
- Rear: 14" x 8" Offset = 76 mm.

### 14" Maverick Beadlock Rim

Maverick, Maverick MAX

**705402393** · Front  
**705502814** · Rear



- Black with clear coat aluminum rim.
- Choice of beadlock color.
- Needs 16 bolts (250000893) for installing the beadlock.
- Front: 14" x 7" Offset = 55 mm (For X rs = Front and rear).
- Rear: 14" x 8" Offset = 76 mm.

### 14" Maverick Beadlock Ring

Maverick & Maverick MAX (X rs, X ds models only)

■ **705401709** · Black  
■ **705401913** · Gold  
■ **705402358** · Can-Am Red  
■ **705402472** · Manta Green



- Cast aluminum beadlock.
- Must be installed on Front Rim (705402393) and Rear Rim (705502814).

# LUBRICANT & OIL CHANGE KIT

## Lubricant

### XPS 4T 10W-50 Synthetic Oil

9779234 (US) · 1 qt / 946 ml

9779240 (EU) · 1 qt / 946 ml

9779235 · 1 US gal / 3.785 L



- Engineered for heavy-duty and high-performance 4-stroke engines, including turbocharged, supercharged and racing engines.
- Formulated using carefully selected and strenuously tested base stocks and custom additives.
- Offers thick film strength to protect bearings, and a proven high-temp detergency to minimize deposits, prevent shear, provide thermal stability, and combat fuel dilution to ensure maximum performance from your engine.

### XPS 4T 0W-40 Synthetic Oil

9779139 (US) · 1 qt / 946 ml

9779286 (EU) · 1 qt / 946 ml

9779140 (US) · 1 US gal / 3.785 L

9779287 (EU) · 1 US gal / 3.785 L



- Powersport formula with premium anti-wear and anti-corrosion additives.
- The best choice for high-performance snowmobile, ATV and SXS 4-stroke engines used in cold weather.
- Provides superior engine and transmission protection against heat, rust and corrosion.
- Delivers optimal performance in high and low temperatures.

### XPS 4T 5W-40 Synthetic Blend Oil

9779133 (US) · 1 qt / 946 ml

9779290 (EU) · 1 qt / 946 ml

9779134 (US) · 1 US gal / 3.785 L

9779291 (EU) · 1 US gal / 3.785 L



- Off-road formula with premium anti-wear and anti-corrosion additives.
- Designed for high-performance off-road, on-road and PWC 4-stroke engines, including turbo or supercharged powersports engines.
- Provides superior engine and transmission protection against rust and corrosion, even in extreme conditions.

## Oil Change Kit

### Engine Oil Change Kit



- Ultra-convenient "all-in-one" Engine Oil Change Kit saves time and money.
- Includes XPS Synthetic or Synthetic Blend Oil, oil filter, O-rings and washer.

### Models

5W-40 Synthetic Blend Oil / 450 cc or less	9779256 (US) 9779408 (EU)
0W-40 Synthetic Oil / 450 cc or less	9779257 (US) 9779409 (EU)
5W-40 Synthetic Blend Oil / 500 cc or more V-twin engine	9779258 (US) 9779405 (EU)
0W-40 Synthetic Oil / 500 cc or more V-twin engine	9779259 (US) 9779406 (EU)
10W-50 Synthetic Oil / 500 cc or more V-twin engine	9779252 (US) 9779401 (EU)
0W-40 Synthetic Oil / 650 ACE	9779481 (US) 9779417 (EU)
5W-40 Synthetic Oil / 650 ACE	9779480 (US) 9779416 (EU)
5W-40 Synthetic Blend Oil / 900 ACE	9779260 (US) 9779410 (EU)
10W-50 Synthetic Oil / 900 ACE	9779261 (US) 9779411 (EU)

# MAINTENANCE PRODUCTS

## Synthetic Gear Oil

75W-90  
75W-140

**9779158** (US) · 1 qt / 946 ml  
**9779212** (EU) · 1 qt / 946 ml  
**9779160** (US)  
**9779215** (EU) · 1 qt / 946 ml



- Uses custom additives to provide the best performance in Visco-Lok™ and Smart-Lok™ differentials.
- Allows higher loads, superior shear stability and reduced oxidation.
- Exceptional wear protection and superior performance at all operating temperatures.

## XPS Synthetic Dct Fluid

(Not illustrated)

**9779710** · 1 qt / 946 ml

- Meets or exceeds API GL-4 industry specifications.
- Formulated for dual clutch system.
- Enhanced cooling capabilities for optimal clutch functionality.
- Anti foaming agents for smooth hydraulic function.

## Extended Life Pre-Mixed Coolant

**9779150** · 1 qt / 946 ml  
**619590728** (Scandinavia) · 1 qt / 946 ml



- Antifreeze/coolant contains the correct dilution and the necessary additives to prevent corrosion and inhibit cavitation in BRP cooling systems.
- Long-life, 5-year formula specially formulated for BRP vehicles.
- Superior heat transfer.
- Ideal replacement for vehicles that normally use a 2-year antifreeze/coolant (green).
- 5 years (orange).

## Anti-Corrosive Lubricant

**9779167** · 12 oz / 340 g  
**619590724** (Scandinavia) · 12 oz / 340 g



- Multipurpose lubricant that can also be used to prevent rust, corrosion and moisture intrusion.
- It contains extreme pressure additives that work as an all-around lubricant for just about anywhere lubrication is needed.

## Extreme Duty Suspension Grease

(Not illustrated)

**9779708** · 14 oz / 400 g

- Designed to work specifically with the components found in Can-Am vehicle suspensions.
- It is highly stable and offers optimal lubrication at both extreme cold and high temperatures while protecting suspension components from dirt and moisture, as well as corrosion under extreme washout conditions.

## XPS Spline Grease

(Not illustrated)

**9779704** (US) · 4 oz / 115 g  
**9779472** (EU) · 4 oz / 115 g

- Enhanced rust and corrosion resistance.
- Protects against seizure, heat-freeze, galling, rust and corrosion.

## DOT 4 Brake Fluid

**9779151** (US) · 12 fl. oz. / 355 ml  
**9779207** (EU) · 12 fl. oz. / 355 ml



- Meets or exceeds all DOT3 and DOT4 brake fluid requirements.
- High-temperature formula resists fade and also conditions seals and O-rings in braking system.

## Racing Brake Fluid RS600

9779152 · 12 fl. oz. / 355 ml



- Exceeds DOT4 brake fluid requirements for extreme conditions and competition use.
- Extreme, 579-degree boiling point temperature is ideal for high-demand competition conditions to combat brake fade.
- Will not harm seals or braking system components.
- Should be added only to a clean/unfilled system to avoid dilution and diminished performance.
- Low-moisture formula slows water vapor absorption through multiple heat cycles.
- Recommended for use in Ski-Doo and Can-Am racing applications.

## Fuel Stabilizer

9779171 (US) · 8 fl. oz. / 236 ml

9779183 (EU) · 8 fl. oz. / 236 ml



- Ethanol-compatible and will stabilize fuel in your tank to keep it from breaking down and causing hard starting, throttle hesitation and poor run quality.
- Since ethanol attracts moisture, this product contains powerful anti-corrosion additives to protect fuel system components.
- Prevents problems associated with E10 fuels.





# BRP REIMAGINES THE WAY YOU ACCESS YOUR WORLD

Can-Am is one of many success stories from BRP, the global company behind some of the most daringly innovative products and experiences that move you. Because it's not about the destination, it's about the journey — yours.

Discover our brands:

*ski-doo* *LYNX* *SEA-DOO* *can-am* *ROTAX* *ALUMACraft* *MANITOU* *QUINTREX*

[www.brp.com](http://www.brp.com)







CANAMOFFROAD.COM

